

COMPRESSOR GUIDE

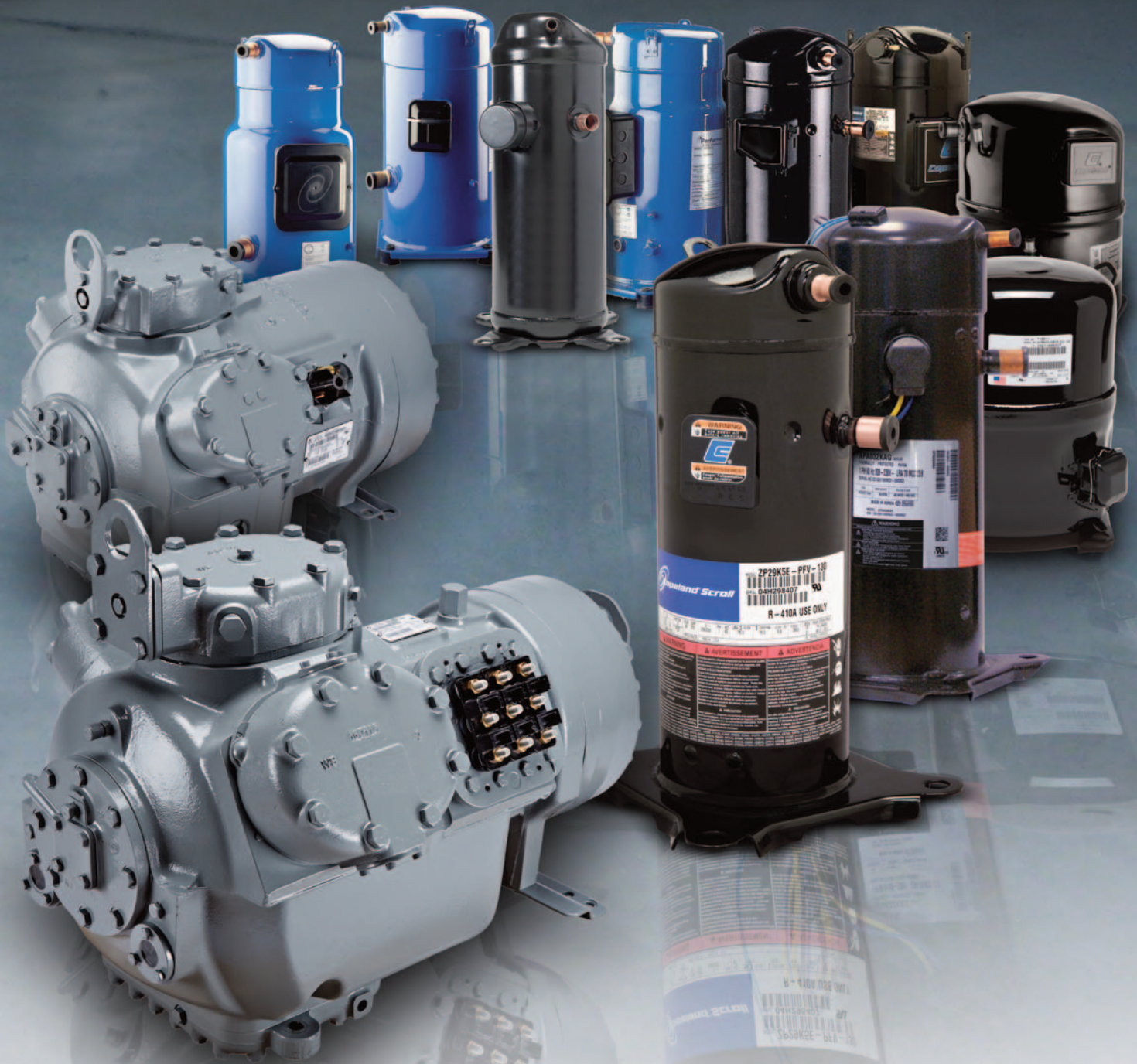

Replacement Components

Carrier

Compressor Guide Table of Contents

COMPRESSOR SELECTION & CROSS REFERENCE TOOL	3
HERMETIC COMPRESSORS	
Copeland Scrolls Compressors	
Copeland R-22 Scrolls	4
Copeland R-22 Tandem Scrolls	4
Copeland R-410A Scrolls.....	5
Copeland R-410A Tandem Scrolls	5
Danfoss Scrolls Compressors	
Danfoss R-22 Performer® Black Scrolls.....	6
Danfoss R-410A Performer® Black Scrolls.....	6
Danfoss Performer® Blue Universal Scrolls	7
Danfoss R-22 Performer® Universal Scrolls Competitive Cross Reference.....	7
Danfoss R-410A Performer® Universal Scrolls Competitive Cross Reference	8
LG Scrolls Compressors	
LG R-22 Scrolls.....	9
LG R-410A Scrolls	9
LG Accessories	9
Copeland Reciprocating Compressors	
Copeland R-22 Recips.....	10
Replacement Reciprocating Compressors	
Drop In Replacements for Trane® Climatuff® Reciprocating Compressors.....	11
Drop In Replacements for Trane® Climatuff® Reciprocating Compressors Cross Reference.....	12
Replacement Compressors Cross Reference Component Chart.....	12
Tecumseh Reciprocating Compressors	
Tecumseh R-22 Recips.....	13
SEMI-HERMETIC COMPRESSORS	
06D Compressor Data	14,15,16
06E Compressor Data	17,18,19
Totaline Compressor Data	20
06CY Compressor Data.....	21
5F & 5H Open Drive Compressor Data	22,23
5F & 5H Compressor Models Available	23
06N Compressor Data	24
06T Compressor Data.....	25
COMPRESSOR ACCESSORIES	
Crankcase Heater Package	26
Capacity Control Valves	26
Bearing Head and Oil Pump.....	27
Valve Plate	27
Filter-Driers.....	28
Totaline® Universal TXV Kits	29
AFTERMARKET A/C CYCLE COMPONENT CHARTS	
1.5 Ton through 8 Ton.....	30
8 Ton through 50 Ton.....	31

Compressor Selection & Cross Reference Tool

We've created a new web tool to help you select the best hermetic and semi-hermetic compressors for out-of-warranty applications. As your Compressor Warehouse, we are confident that this tool will help you search through the large number of compressors available to you; to zero in on the right selection almost instantaneously! This tool will save you valuable time while ensuring you get the right compressor for your customer.

To access the **Selection & Cross Reference** tool visit: partscenter.totaline.com and make your selection. You may also access this tool through www.rchvacparts.com. Dealers can access through the Tools Tab and Distributors under the Quick Links Tab.

You will be brought to a top-level screen where you have your choice on whether you would like to use the Selection Tool or Cross-Reference Tool. By entering the appropriate fields in either window, you will be presented with the list of possible replacements, many of which you will probably have in stock.

The Selection Tool is easy to use and ready for you today. Your Zone Sales Manager can help review the tool with you and show you how it works.

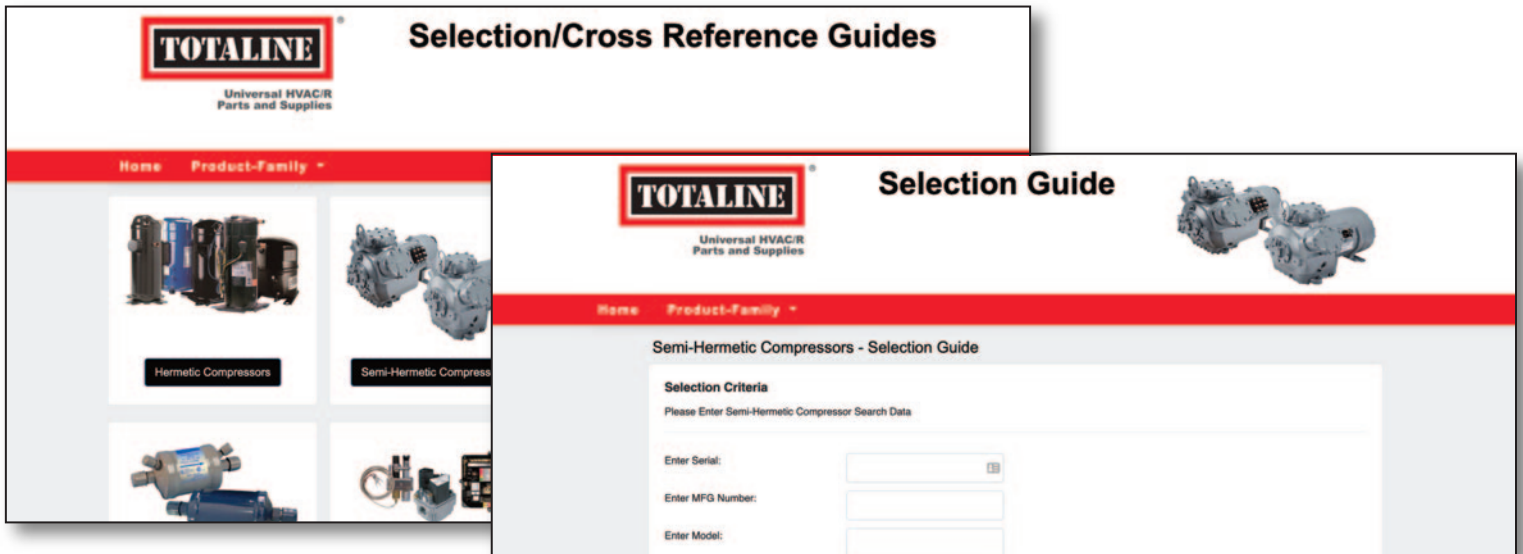

Hermetic Compressors

Copeland R-22/R-407C Scrolls

COPELAND R-22 SCROLLS					
BTU/HR	208-230/1/60		208-230/3/60	460/3/60	575/3/60
	Product #	Run Cap	Product #	Product #	Product #
16,000	ZR16K5E-PFV-830	30/370			
18,000	ZR18K5E-PFV-830	30/370			
21,000	ZR21K5E-PFV-830	35/370	ZR21K5E-TF5-830	ZR21K5E-TFD-830	
25,000	ZR25K5E-PFV-830	40/370	ZR25K5E-TF5-830	ZR25K5E-TFD-830	
28,000	ZR28K5E-PFV-830	45/370	ZR28K5E-TF5-830	ZR28K5E-TFD-830	
32,000	ZR32K5E-PFV-830	50/370	ZR32K5E-TF5-830	ZR32K5E-TFD-830	ZR32K5E-TFE-830
38,000	ZR38K5E-PFV-830	55/370	ZR38K5E-TF5-830	ZR38K5E-TFD-830	ZR38K5E-TFE-830
42,000	ZR42K5E-PFV-830	55/370	ZR42K5E-TF5-830	ZR42K5E-TFD-830	ZR42K5E-TFE-830
44,000	ZR44K5E-PFV-830	60/370	ZR44K5E-TF5-830	ZR44K5E-TFD-830	ZR44K5E-TFE-830
48,000	ZR48K5E-PFV-830	60/440	ZR48K5E-TF5-830	ZR48K5E-TFD-830	ZR48K5E-TFE-830
54,000	ZR54K5E-PFV-830	80/370	ZR54K5E-TF5-830	ZR54K5E-TFD-830	ZR54K5E-TFE-830
57,000	ZR57K3E-PFV-830*	80/370	ZR57K3E-TF5-830*	ZR57K3E-TFD-830*	ZR57K3E-TFE-830*
61,000	ZR61K3E-PFV-830*	80/370	ZR61K3E-TF5-830*	ZR61K3E-TFD-830*	ZR61K3E-TFE-930
68,000	ZR68KCE-PFV-950	80/440	ZR68KCE-TF5-950	ZR68KCE-TFD-950	ZR68KCE-TFE-930
72,000			ZR72KCE-TF5-950**	ZR72KCE-TFD-950**	ZR72KCE-TFE-950**
81,000			ZR81KCE-TF5-965*	ZR81KCE-TFD-950***	
90,000			ZR90K3E-TWC-922****	ZR90K3E-TWD-922****	ZR90K3E-TWE-922****
94,000			ZR94KCE-TF5-950	ZR94KCE-TFD-950***	ZR94KCE-TFE-950
108,000			ZR108KCE-TF5-950***	ZR108KCE-TFD-950***	ZR108KCE-TFE-950***
110,000			ZR11M3E-TWC-922****	ZR11M3E-TWD-922****	ZR11M3E-TWE-961
120,000			ZR12M3E-TWC-922****	ZR12M3E-TWD-922****	ZR12M3E-TWE-922****
125,000			ZR125KCE-TF5-950***	ZR125KCE-TFD-950***	ZR125KCE-TFE-950***
144,000			ZR144KCE-TF5-950***	ZR144KCE-TFD-950***	ZR144KCE-TFE-950
160,000			ZR16M3E-TWC-922****	ZR16M3E-TWD-922****	ZR16M3E-TWE-922****
190,000			ZR19M3E-TWC-922****	ZR19M3E-TWD-922****	ZR19M3E-TWE-922****
			ZR190KCE-TE5-950***	ZR190KCE-TED-950	ZR190KCE-TEE-950
250,000			ZR300KCE-TWC-951***	ZR250KCE-TED-951***	
300,000			ZR300KCE-TEC-951***	ZR300KCE-TED-951***	

- * BOM 930 and/or 950 are also available (square fence, straight stubs)
- ** BOM 830 is also available (round fence, molded plug w/pin terminals, straight stubs)
- *** BOM 965 is also available (rotalock connections)
- **** BOM 961 is also available (rotalock connections)

Copeland R-22/R-407C Tandem Scrolls

COPELAND R-22 TANDEM SCROLLS		
BTU/HR	460/3/60	Copeland Compressor Notes
	Product #	
191,500	ZRT188KCE-TFD-950	Suction and Discharge stub tubes
217,000	ZRT216KCE-TF5-975	Suction and Discharge stub tubes
251,000	ZRT250KCE-TFD-975	Suction and Discharge stub tubes
252,000	ZRT250KCE-TFD-950	Suction and Discharge stub tubes
286,000	ZRT288KCE-TFD-950	Suction and Discharge stub tubes
309,000	ZRT320KCE-TED-976	Suction and Discharge stub tubes
380,000	ZRT380KCE-TED-976	Suction and Discharge stub tubes
482,000	ZRT500KCE-TED-951	Suction and Discharge stub tubes
586,000	ZRT600KCE-TED-951	Suction and Discharge stub tubes



All Copeland KF, KA, & KC scrolls are identical to the latest K5 design...

Hermetic Compressors

Copeland R-410A Scrolls

COPELAND R-410A SCROLLS					
BTU/HR	208-230/1/60		208-230/3/60	460/3/60	575/3/60
	Product #	Run Cap	Product #	Product #	Product #
15,500	ZP16K5E-PFV-830	35/370			
20,000	ZP20K5E-PFV-830	35/370	ZP20K5E-TF5-830	ZP20K5E-TFD-830	
21,300	ZP21K5E-PFV-830	40/370			
24,000	ZP24K5E-PFV-830	40/370	ZP24K5E-TF5-830	ZP24K5E-TFD-830	
25,200	ZP25K5E-PFV-830	40/370		ZP25K5E-TFD-830	
29,000	ZP29K5E-PFV-830	45/370	ZP29K5E-TF5-830	ZP29K5E-TFD-830	
31,100	ZP31K5E-PFV-830	45/370	ZP31K5E-TF5-830	ZP31K5E-TFD-830	ZP31K5E-TFE-830
36,000	ZP36K5E-PFV-830	45/370	ZP36K5E-TF5-830*	ZP36K5E-TFD-830	ZP36K5E-TFE-830
37,500	ZP38K5E-PFV-830	45/370	ZP38K5E-TF5-830	ZP38K5E-TFD-830	ZP38K5E-TFE-830
42,000	ZP42K5E-PFV-830	70/370	ZP42K5E-TF5-830	ZP42K5E-TFD-830	ZP42K5E-TFE-830
51,000	ZP51K5E-PFV-830	70/370	ZP51K5E-TF5-830	ZP51K5E-TFD-830	ZP51K5E-TFE-830
54,000	ZP54K5E-PFV-830	80/370	ZP54K5E-TF5-830	ZP54K5E-TFD-830	ZP54K5E-TFE-830
57,000	ZP57K5E-PFV-830	80/370	ZP57K5E-TF5-830	ZP57K5E-TFD-830	
61,500	ZP61K5E-PFV-830	80/370	ZP61KCE-TF5-830*	ZP61KCE-TFD-830*	ZP61KCE-TFE-830*
72,000			ZP72KCE-TF5-830*	ZP72KCE-TFD-830*	ZP72KCE-TFE-830
77,000			ZP76KCE-TF5-830*	ZP76KCE-TFD-830*	ZP76KCE-TFE-830*
83,000			ZP83KCE-TF5-830*	ZP83KCE-TFD-830*	ZP83KCE-TFE-830*
90,500			ZP90KCE-TF5-950**	ZP90KCE-TFD-950**	ZP90KCE-TFE-950**
105,000			ZP103KCE-TF5-950**	ZP103KCE-TFD-950**	ZP103KCE-TFE-950**
123,000			ZP120KCE-TF5-950**	ZP120KCE-TFD-950**	ZP120KCE-TFE-950**
135,000			ZP137KCE-TF5-950**	ZP137KCE-TFD-950**	ZP137KCE-TFE-950**
155,000			ZP154KCE-TE5-950***	ZP154KCE-TED-950	ZP154KCE-TEE-950
183,000			ZP182KCE-TE5-950***	ZP182KCE-TED-950***	ZP182KCE-TEE-950
235,000			ZP235KCE-TEC-750***	ZP235KCE-TED-750	ZP235KCE-TEE-750
294,000			ZP295KCE-TEC-750	ZP295KCE-TED-750	ZP295KCE-TEE-750

* 930, 950 and/or 7M7 BOM are also available

** 855 BOM is also available

*** 965 BOM is also available

Copeland R-410A Tandem Scrolls

COPELAND R-410A TANDEM SCROLLS			
BTU/HR	200-230/3/60	460/3/60	Copeland Compressor Notes
	Product #	Product #	
164,000	ZPT166KCE-TF5-950	ZPT166KCE-TFD-950	Suction and Discharge stub tubes
181,000	ZPT180KCE-TF5-975	ZPT180KCE-TFD-975	Suction and Discharge stub tubes
210,000	ZPT206KCE-TF5-975	ZPT206KCE-TFD-975	Suction and Discharge stub tubes



Hermetic Compressors

Danfoss R-22 Performer® Black Scrolls

DANFOSS R-22 PERFORMER BLACK SCROLLS			
BTU/HR	460/3/60		575/3/60
	Product #	Run Cap	Product #
34,000	XCH342HA		
40,000	HRP042T4LP6		
47,000			HRM047U7LP6
58,000			HRM060U7LC6A
60,000			HRM060U7LC6A

BOM LC6 - brazed connections, screw terminals

BOM LP6 - brazed connections, spade terminals

Danfoss R-410A Performer Black Scrolls

DANFOSS R-410A PERFORMER BLACK SCROLLS		
BTU/HR	208-230/1/60 Product #	Run Cap
35,400	HRH036U1LP6	55/370
39,500	HRH039U1LP6	60/370
41,503	HRH040U1LP6	60/370
54,520	HRH054U1LP6	80/440

BOM LC6 - brazed connections, screw terminals

BOM LP6 - brazed connections, spade terminals

All our compressors can be used not only as replacements on Carrier units, but for other manufacturer's as well...

Hermetic Compressors

Danfoss R-22 Performer® Blue Universal Scroll Compressor

DANFOSS PERFORMER® UNIVERSAL SCROLL COMPRESSOR PRODUCT RANGE

Code No.	Nominal Tonnage
P040-11551	9.3
SM115-4QAI	9.3
SM125-3QAI	10
SM125-4QAI	10
SM175-3QAI	14
SM175-4QAI	14
SM185-3QAI	15
SM185-4QAI	15



Competitor Cross Reference

COMPETITOR CROSS REFERENCE¹

Nominal Tonnage	Competitor Part Number		RC Part Number ^{2,3}	Capacity BTU/HR	Volt / Phase / Hz	Weight (Lbs.)	Connection Size (inches) Suction X Discharge Type (Braze)	Solder Sleeve Adaptor Set for Rotolock Connectors ⁴
9.3	CSHA-093R-0*00 or 0A	ZR108KC-TF5	P040-11551	115,215	200-230/3/60	172	1-3/8 x 7/8	120Z0405
9.3	CSHA-093K-0*00 or 0A	ZR108KC-TFD	SM115-4QAI	115,215	460/3/60 400/3/50	172	1-3/8 x 7/8	120Z0405
9.3	CSHS-093R-0*00 or 0A	ZR11M3-TWC	P040-11551	115,215	200-230/3/60	172	1-3/8 x 7/8	120Z0405
9.3	CSHS-093K-0*00 or 0A	ZR11M3-TWD	SM115-4QAI	115,215	460/3/60 400/3/50	172	1-3/8 x 7/8	120Z0405
10	CSHA-100R-0*00 or 0A	ZR125KC-TF5	SM125-3QAI	126,423	200-230/3/60	172	1-3/8 x 7/8	120Z0405
10	CSHA-100K-0*00 or 0A	ZR125KC-TFD	SM125-4QAI	126,423	460/3/60 400/3/50	172	1-3/8 x 7/8	120Z0405
10	CSHS-100R-0*00 or 0A	ZR12M3-TWC	SM125-3QAI	126,423	200-230/3/60	172	1-3/8 x 7/8	120Z0405
10	CSHS-100K-0*00 or 0A	ZR12M3-TWD	SM125-4QAI	126,423	460/3/60 400/3/50	172	1-3/8 x 7/8	120Z0405
12.5	CSHA-125R-0*00 or 0A	ZR16M3-TWC	P040-16351	163,008	200-230/3/60	198	1-5/8 x 1-1/8	7765028
12.5	CSHA-125K-0*00 or 0A	ZR16M3-TWD	P040-16371	163,008	460/3/60 400/3/50	220	1-5/8 x 1-1/8	7765028
14	CSHA-140R-0*00 or 0A	-	SM175-3QAI	174,355	200-230/3/60	220	1-5/8 x 1-1/8	7765028
14	CSHA-140K-0*00 or 0A	-	SM175-4QAI	174,355	460/3/60 400/3/50	220	1-5/8 x 1-1/8	7765028
14	CSHS-140R-0*00 or 0A	-	SM175-3QAI	174,355	200-230/3/60	220	1-5/8 x 1-1/8	7765028
14	CSHS-140K-0*00 or 0A	-	SM175-4QAI	174,355	460/3/60 400/3/50	220	1-5/8 x 1-1/8	7765028
15	CSHA-150R-0*00 or 0A	ZR190KC-TW5	SM185-3QAI	185,474	200-230/3/60	220	1-5/8 x 1-1/8	7765028
15	CSHA-150K-0*00 or 0A	ZR190KC-TWD	SM185-4QAI	185,474	460/3/60 400/3/50	220	1-5/8 x 1-1/8	7765028
15	CSHS-150R-0*00 or 0A	ZR19M3-TWC	SM185-3QAI	185,474	200-230/3/60	220	1-5/8 x 1-1/8	7765028
15	CSHS-150K-0*00 or 0A	ZR19M3-TWD	SM185-4QAI	185,474	460/3/60 400/3/50	220	1-5/8 x 1-1/8	7765028

¹ As with any new compressor installation, verify that the electrical components and wiring of the system are properly sized for the new compressor and are in good working condition.

² Performer® "Q-version" (as in SM115-3QAI) includes welded sightglass, oil equalization port, brazed ports, and mounting bracket. "C-version" (as in SM160-3CBI) include welded sightglass, oil equalization port, and brazed ports.

³ Trane CSHA and CSHS compressors ending in 0 and A come with brazed ports. Models ending in B come with Rotolock fittings.

⁴ To replace compressors with Rotolock fittings, use the compressor code numbers above with the appropriate solder sleeve adapter set or contact Danfoss Application Engineering to identify code for Rotolock compressor.

*Drop-in Trane replacement scrolls are now available for both R-22 & R-410A...
see next page for R-410A*

Hermetic Compressors

Danfoss R-410A Performer® Blue Universal Scroll Compressor

REPLACEMENT COMPETITOR CROSS REFERENCE

Nominal Tonnage	Competitor Part Number ²		RC Part Number	Volts / Phase @ 60Hz	Motor Module Voltage	Capacity BTU/HR	Weight (LBS)	Connection Size (inches) Suction X Discharge Type (Brazed)	Electronic Motor Protection Module ¹	Solder Sleeve Adaptor Set for Rotolock Connectors	
7.5	CSHD092J0A0M	CSHD089J0A0M	ZP90KCE-TF5	SH090A3ALC	200-230/3	N/A	92500	128	1-1/8 x 7/8	N/A	120Z0125
7.5	CSHD092K0A0M	CSHD089K0A0M	ZP90KCE-TFD	SH090A4ALC	460/3	N/A	92500	128	1-1/8 x 7/8	N/A	120Z0125
7.5	CSHD092D0A0M	CSHD089D0A0M	ZP90KCE-TFE	SH090A7ALC	575/3	N/A	92500	128	1-1/8 x 7/8	N/A	120Z0125
9	CSHD110J0A0M	CSHD105J0A0M	ZP103KCE-TF5	SH105A3ALC	200-230/3	N/A	109,500	141	1-3/8 x 7/8	N/A	120Z0405
9	CSHD110K0A0M	CSHD105K0A0M	ZP103KCE-TFD	SH105A4ALC	460/3	N/A	109,500	141	1-3/8 x 7/8	N/A	120Z0405
9	CSHD110D0A0M	CSHD105D0A0M	ZP103KCE-TFE	SH105A7ALC	575/3	N/A	109,500	141	1-3/8 x 7/8	N/A	120Z0405
10	CSHD125J0A0M	CSHD120J0A0M	ZP120KCE-TF5	SH120A3ALC	200-230/3	N/A	125,400	141	1-3/8 x 7/8	N/A	120Z0405
10	CSHD125K0A0M	CSHD120K0A0M	ZP120KCE-TFD	SH120A4ALC	460/3	N/A	125,400	141	1-3/8 x 7/8	N/A	120Z0405
10	CSHD125D0A0M	CSHD120D0A0M	ZP120KCE-TFE	SH120A7ALC	575/3	N/A	125,400	141	1-3/8 x 7/8	N/A	120Z0405
12	CSHD142J0A0M	CSHD136J0A0M	ZP137KCE-TF5	SH140A3ALC	200-230/3	N/A	144,300	148	1-3/8 x 7/8	N/A	120Z0405
12	CSHD142K0A0M	CSHD136K0A0M	ZP137KCE-TFD	SH140A4ALC	460/3	N/A	144,300	148	1-3/8 x 7/8	N/A	120Z0405
12	CSHD142D0A0M	CSHD136D0A0M	ZP137KCE-TFE	SH140A7ALC	575/3	N/A	144,300	148	1-3/8 x 7/8	N/A	120Z0405
13	CSHD161J0A0M	CSHD155J0A0M	ZP154KCE-TF5	SH161A3ALC	200-230/3	N/A	160,900	152	1-3/8 x 7/8	N/A	120Z0405
13	CSHD161K0A0M	CSHD155K0A0M	ZP154KCE-TFD	SH161A4ALC	460/3	N/A	160,900	152	1-3/8 x 7/8	N/A	120Z0405
13	CSHD161D0A0M	CSHD155D0A0M	ZP154KCE-TFE	SH161A7ALC	575/3	N/A	160,900	152	1-3/8 x 7/8	N/A	120Z0405
15	CSHD183J0A0M	CSHD175J0A0M	ZP182KCE-TW5	SH184A3ALC	200-230/3	N/A	184,400	158	1-3/8 x 7/8	N/A	120Z0405
15	CSHD183K0A0M	CSHD175K0A0M	ZP182KCE-TWD	SH184A4ALC	460/3	N/A	184,400	158	1-3/8 x 7/8	N/A	120Z0405
15	CSHD183D0A0M	CSHD175D0A0M	ZP182KCE-TWE	SH184A7ALC	575/3	N/A	184,400	158	1-3/8 x 7/8	N/A	120Z0405
15.3	CSHN184J0AHM	CSHN176J0AHM	-	P045-18351	200-230/3	24VAC	183,400	234	1-5/8 x 1-1/8	8169020	7765028
15.3	CSHN184J0AKM	CSHN176J0AKM	-	P045-18352	200-230/3	115/230VAC	183,400	234	1-5/8 x 1-1/8	8169021	7765028
15.3	CSHN184K0AHM	CSHN176K0AHM	-	P045-18571	460/3	24VAC	183,400	234	1-5/8 x 1-1/8	8169020	7765028
15.3	CSHN184K0AKM	CSHN176K0AKM	-	P045-18572	460/3	115/230VAC	183,400	234	1-5/8 x 1-1/8	8169021	7765028
15.3	CSHN184D0AHM	CSHN176D0AHM	-	P045-18381	575/3	24VAC	183,400	234	1-5/8 x 1-1/8	8169020	7765028
15.3	-	-	-	P045-18382	575/3	115/230VAC	183,400	234	1-5/8 x 1-1/8	8169021	7765028
20	CSHN250J0AHM	CSHN240J0AHM	ZP235KCE-TW5	P045-25151	200-230/3	24VAC	251,000	238	1-5/8 x 1-1/8	120Z0584	7765028
20	CSHN250J0AKM	CSHN240J0AKM	-	P045-25152	200-230/3	115/230VAC	251,000	238	1-5/8 x 1-1/8	8169016	7765028
20	CSHN250K0AHM	CSHN240K0AHM	ZP235KCE-TWD	P045-24671	460/3	24VAC	251,000	238	1-5/8 x 1-1/8	120Z0584	7765028
20	CSHN250K0AKM	CSHN240K0AKM	-	P045-24672	460/3	115/230VAC	251,000	238	1-5/8 x 1-1/8	8169016	7765028
20	CSHN250D0AHM	CSHN240D0AHM	ZP235KCE-TWE	P045-25082	575/3	24VAC	251,000	238	1-5/8 x 1-1/8	120Z0584	7765028
20	CSHN250D0AKM	CSHN240D0AKM	-	P045-25083	575/3	115/230VAC	251,000	238	1-5/8 x 1-1/8	8169016	7765028
26	CSHN315J0AHM	-	ZP295KCE-TW5	P045-31751	200-230/3	24VAC	317,600	337	1-5/8 x 1-1/8	120Z0584	7765028
26	CSHN315J0AKM	-	-	P045-31752	200-230/3	115/230VAC	317,600	337	1-5/8 x 1-1/8	8169016	7765028
26	CSHN315K0AHM	-	ZP295KCE-TWD	P045-31772	460/3	24VAC	317,600	337	1-5/8 x 1-1/8	120Z0584	7765028
26	CSHN315K0AKM	-	-	P045-31773	460/3	115/230VAC	317,600	337	1-5/8 x 1-1/8	8169016	7765028
26	CSHN315D0AHM	-	ZP295KCE-TWE	P045-31682	575/3	24VAC	317,600	337	1-5/8 x 1-1/8	120Z0584	7765028
26	CSHN315D0AKM	-	-	P045-31683	575/3	115/230VAC	317,600	337	1-5/8 x 1-1/8	8169016	7765028
31	CSHN374J0AHM	-	ZP385KCE-TW5	P045-37451	200-230/3	24VAC	374,300	362	1-5/8 x 1-1/8	120Z0584	7765028
31	CSHN374J0AKM	-	-	P045-37452	200-230/3	115/230VAC	374,300	362	1-5/8 x 1-1/8	8169016	7765028
31	CSHN374K0AHM	-	ZP385KCE-TWD	P045-37471	460/3	24VAC	374,300	362	1-5/8 x 1-1/8	120Z0584	7765028
31	CSHN374K0AKM	-	-	P045-37472	460/3	115/230VAC	374,300	362	1-5/8 x 1-1/8	8169016	7765028
31	CSHN374D0AHM	-	ZP385KCE-TWE	P045-36781	575/3	24VAC	374,300	362	1-5/8 x 1-1/8	120Z0584	7765028
31	CSHN374D0AKM	-	-	P045-36782	575/3	115/230VAC	374,300	362	1-5/8 x 1-1/8	8169016	7765028

Hermetic Compressors

LG R-22/R-407C Scrolls, Mineral Oil

LG R-410A Scrolls, POE Oil

LG SCROLLS		
BTU/HR	208-230/3/60	460/3/60
	Product #	Product #
62,000	SR061RBD	
61,500		SR061SAB

LG R-410A SCROLLS		
BTU/HR	208-230/1/60	
	Product #	Run Cap
15,200	APA016KAC	35/370
19,500	APA020KAC	35/370
22,400	APA024KAB	40/370
28,000	APA029KAC	45/440
30,500	APA032KAG	45/440
37,700	AQA038KAB	60/440
39,000	AQA039KAC	60/440
41,500	AQA042KAE	70/440
48,000	ABA049KAB	70/440
51,500	ABA051KAF	75/440
61,500	ABA054KAC	80/440



LG Accessories

LG ACCESSORIES			
Description	Legacy Part Number	Service Part Number	Comments
Thermal Cut Out	RTC0061	AGG74119701	For use on all models
Molded Plug Assy	RMP0051	AGG74119801	For use on all R-410A models
Molded Plug Assy	-	AGG74119802	For use on R-22 SQA models
Molded Plug Assy	-	AGG74119803	For use on R-22 SR single phase models
Molded Plug Assy	-	AGG74119804	For use on R-22 SR three phase models
40W, 240V Crankcase Heater	-	P041-4443	For use on APA, AQA, ABA, SQA models
70W, 240V Crankcase Heater	-	HT32BH857	For use on all R-22 SR models

*Majority of hermetic compressors have compatible mounting (7.5" X 7.5")
& piping differences are minimal.....*

Hermetic Compressors

Copeland R-22/R-407C Recips

COPELAND R-22 RECIPS					
BTU/HR	208-230/1/60		208-230/3/60	460/3/60	575/3/60
	Product #	Run Cap	Product #	Product #	Product #
16,300	CR16K6E-PFV-775	25/370			
18,000	CR18K6E-PFV-775	25/370	CR18K6E-TF5-775	CR18K6E-TFD-775	
22,100	CR22K6E-PFV-775	30/370	CR22K6E-TF5-775	CR22K6E-TFD-775	
24,500	CR24K6E-PFV-775	35/370	CR24K6E-TF5-775	CR24K6E-TFD-775	
28,200	CR28K6E-PFV-775	35/370	CR28K6E-TF5-775	CR28K6E-TFD-775	
34,500	CR34K6E-PFV-775	50/370	CR35K6E-TF5-775	CR35K6E-TFD-775	CR35K6E-TFE-775
41,900	CR42K6E-PFV-775	40/370	CR42K6E-TF5-775	CR42K6E-TFD-775	CR42K6E-TFE-775
47,500	CR47KQE-PFV-970	45/440	CR47KQE-TF5-970	CR47KQE-TFD-970	
53,300	CR53KQE-PFV-970	60/440	CR53KQE-TF5-970	CR53KQE-TFD-970	
54,100	CRPQ-045E-PFV-970	45/440	CRPQ-045E-TF5-970	CRPQ-045E-TFD-970	CRPQ-045E-TFE-970
54,100	CR53KQE-PFV-970	45/440	CR53KQE-TF5-970	CR53KQE-TFD-970	
60,600	CRNQ-050E-PFV-970	55/440	CRNQ-050E-TF5-970	CRNQ-050E-TFD-970	CRNQ-050E-TFE-970



Just like older Copeland Scrolls are interchangeable with latest design scroll models, older version Copeland Recips are also interchangeable with latest design recip models...

Hermetic Compressors

Drop-In Replacements for Trane® Climatuff® Reciprocating Compressors



Now, a drop-in replacement for your customers that are working on Trane® units with Climatuff® reciprocating compressors in only two steps!

Step One: Verify it's a Climatuff® reciprocating compressor by asking if it's:

1. **ORANGE** in color?
2. Mounted on three legs?
3. Uses refrigerant R-22?
4. Connections are Rotolock®?

If all answers are **YES**, you now have a replacement opportunity!



Step Two: Select the replacement part number in **Table 1** once you determine:

1. The distance between suction to discharge fittings (either 7.5" or 9")
- and**
2. The nominal capacity in tons

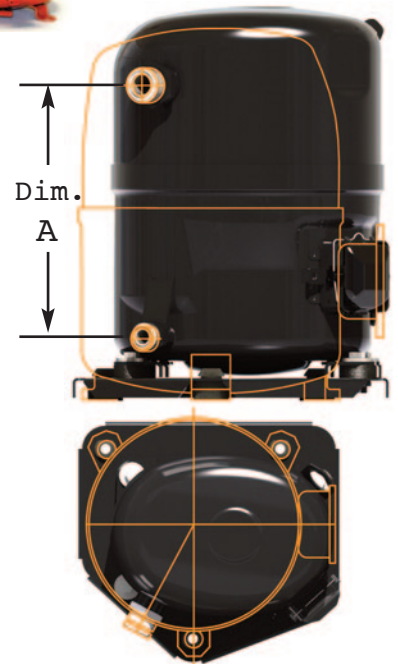

Table 1

Drop-in Replacement Part Number	Suction to Discharge (Dimension A) Measure Centerline to Centerline	Nominal Capacity (tons)
HTRB183ABCS	9"	1.5
HTRB253ABCS	9"	2
HTRJ303ABCT	7.5"	2.5
HTRJ363ABCT	7.5"	3

Drop-in replacement part numbers all have the same fit and function as the original reciprocating compressor:

1. **BLACK** in color (and comes with a molded plug in the box)
2. Same three-leg mount
3. Charged with POE oil (so may be used with R-22 or R-407C)
4. Same rotolock configuration as TRANE®, American Standard® and Maneurop®
5. Same suction to discharge fitting distance
6. Same nominal capacity

See cross-reference on next page for more details.

Hermetic Compressors

Cross Reference Table

Trane Compressors				Replacement Compressors							
Trane Model Number*	Trane Part Number	Trane Cylinders	Trane Shell Height (in)	Part Number	Capacity (tons)	Electrical	Cylinders	Rotolock Size (Suction/ Discharge)	Suction to Discharge Differential	Ship Weight	Shell Height (in)
AL17A-AA1-A	COM06961	1	13.0	HTRB183ABCS	1.5	208/230-1-60	2	1.25" S-12THR/ 1" D-14THR	9"	82 lbs	13.2
AP19A-8A1-JA	COM08671		14.0								
AP21A-BC1-A	COM06355		14.0								
AS17A-AA1-A	COM07003		13.0								
BH173-ZA1-G	COM03728		13.2								
BH193-AB1-GA	COM03719		13.2								
BH193-AB1-GB	COM04324		13.2								
BP173-ZA1-A	COM02795		14.2								
BP173-ZA1-G	COM03693		14.2								
AL22A-CC1-A	COM06400		13.0	HTRB253ABCS	2						
AL24A-CD1-A	COM06920		13.0								
AP24A-CD1-JA	COM08672		14.0								
AS22A-CC1-A	COM06965		14.0								
AS24A-CD1-A	COM06980		14.0								
BH223-BC1-GC	COM04326		14.2								
BH233-CC1-GA	COM03729		14.2								
BJ223-BC1-GA	COM03729	14.2									
BP223-BC1-GA	COM06315	14.2									
BP233-CC1-GA	COM06329	14.2									
CP223-BC1-A	COM02750	15.6	HTRJ303ABCT	2.5							
CP223-BC1-G	COM03688	15.6									
FH283-EE1-G	COM04272	16.6									
GP283-EE1-A	COM02755	16.6									
GP283-EE1-G	COM03689	16.6									
GP293-EF1-JA	COM08673	15.6		HTRJ363ABCT	3						
FH343-FG1-GA	COM03762	16.6									
FH373-GG1-GA	COM03717	16.6									
GP343-FG1-GA	COM03690	16.6									
GP373-8F1-JA	COM08676	15.6									
GP373-GG1-A	COM02630	16.6					1.75" S-12THR/ 1.25" D-12THR	7.5"	98 lbs	15.9	16.1

* Cross-references are not limited to suggested models shown. Box dimensions for all replacement compressors are 18 X 18 X 20

Replacement Compressors Component Chart

Part Number	ARI Capacity	LRA	Start Cap MFD/Volts	Totaline Start Capacitor Part Number	Start Relay	Run Cap MFD/Volts	Totaline Run Capacitor Part Number	Totaline Liquid Line Filter Drier Part Number	Totaline Heat Pump Filter Drier Part Number
HTRB183ABCS	17800	48	161-193/250	P281-1615	GE 3ARR3*3V*()	35/370	P291-4054RS	P502-8083S	P504-H083S
HTRB253ABCS	23000	61	145-175/250	P281-1455	GE 3ARR3*3T*()	35/370	P291-4054RS	P502-8083S	P504-H083S
HTRJ303ABCT	28200	78	189-227/330	P281-1896S	GE 3ARR3*3S*()	40/370	P291-4054RS	P502-8163S	P504-H163S
HTRJ363ABCT	34200	78	189-227/330	P281-1896S	GE 3ARR3*3S*()	45/370	P291-5054RS	P502-8163S	P504-H163S

* Go to Totaline.com to browse our catalog for additional run capacitors and liquid-line or heat pump driers.

Hermetic Compressors

Tecumseh R-22/R-407C Recips

TECUMSEH R-22 RECIPS							
BTU/HR	208-230/1/60			208-230/3/60		460/3/60	
	Product #	Tecumseh Model Number	Run Cap	Product #	Tecumseh Model Number	Product #	Tecumseh Model Number
15,000	P031-1524	AKA8515EXD	15/440				
19,000	P031-19210	AWF5519EXN	35/370				
24,400	P031-2429	AWF5542EXN	35/370				
28,000				P031-2854	AWF5528EXT		
32,200	P031-3025	AWG5530EXN	45/370				
35,000	P031-3522	AVB5535EXN	45/370				
37,750	P031-3822	AVA5538EXN	35/440				
46,000	P031-4622	AVA5546EXN	40/440				
53,000	P031-5321	AGA5553EXN	45/440	P031-5351	AGA5553EXT	P031-5371	AGA5553EXG
60,000	P031-6121	AGA5561EXN	55/440	P031-6151	AGA5561EXT	P031-6171	AGA5561EXG
66,850				P031-6851	AGA5568EXT	P031-6871	AGC5568EXG

Changing a Hermetic Compressor? Remember to pick up . . .

- Hermetic Compressor
- Start Capacitor
- Run Capacitor
- Copper Fittings
- Solder & Flux
- Sanding Cloth
- Wire Nuts
- Electrical Tape
- Totaltest Kit
- Liquid Drier
- Suction Drier
- Refrigerant
- Refrigerant Oil
- Start Relay
- Crankcase Heater
- Compressor Lead Kit
- Phase Monitor
- Smart Start Kit
- Acetylene

Semi-Hermetic Compressors

Are You Still UL Safe?

Using A Non-UL Recognized Service Compressor Could Invalidate The Original UL Listing For Your Entire Air Conditioning System.

Only Genuine Carlyle Service Compressors offer something no rebuilt Carlyle compressor can match: Official UL Recognition. That means every Genuine Carlyle Service Compressor has been built to comply with internationally recognized safety standards, minimizing the risk of fire, electric shock, or other safety hazards. UL also conducts ongoing, unannounced audits at our facility four times a year. This ensures that Genuine Carlyle Service Compressors meet the most widely recognized and trusted safety standards in the industry.

Don't take the risk of using a non-UL recognized service compressor. Remember, if the  symbol does not appear on the compressor nameplate you are not taking advantage of the "peace of mind" that only UL Recognition brings.

Ask your distributor about the difference between a rebuilt compressor and a Genuine Carlyle Service Compressor. Then ask yourself why would you settle for anything less than the one that is UL Recognized.















For help in finding a Carlyle Distributor near you, visit us at www.totaline.com

Make Sure Your Service Compressor Has the UL Recognition It Needs To Meet Safety Code Requirements That Guard Against Fire And Explosions!



REAL RELIABILITY DELIVERED IN THE REAL WORLD

Carlyle offers a full line of New and factory Remanufactured compressors. Find the right compressor for every application!

										
			06D/6D	06E/6E	06CC/CY	06M	06N	5F, 5H	Screw Except 74mm	Screw 74mm
NEW		PREMIUM Up to 3-year warranty*	✓	✓	✓	✓	✓	✓	✓	✓
REMANUFACTURED		DELUXE 2-year warranty	✓	✓	✓	n/a	n/a	✓	n/a	n/a
		STANDARD 1-year warranty	✓	✓	n/a	n/a	n/a	n/a	n/a	n/a
		UL	✓	✓	✓	✓	✓	✓	✓	✓
		Extended Warranty Available	✓	✓	✓	✓	✓	✓	✓	✓
		Country of Origin	USA	USA	USA	USA	USA	USA	USA	USA

* OEM warranties on new compressors may vary - check with your Carlyle salesperson for details.

Semi-Hermetic Compressors

Compressor Model Number Significance 06D COMPRESSORS

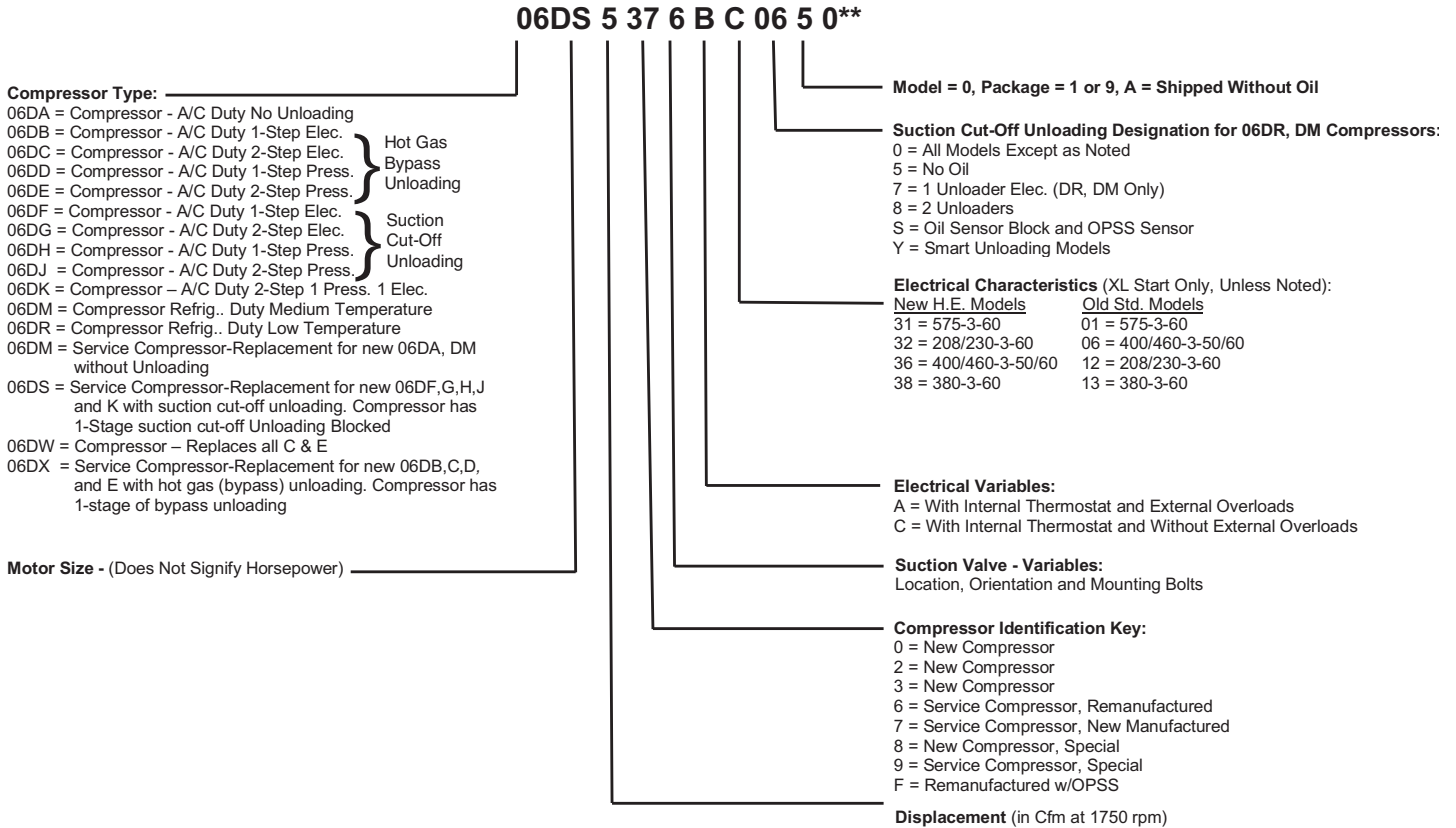

**Refrigeration Partner. Only authorized members have access to these compressor models.

Semi-Hermetic Compressors

Compressor Model Number Significance 6D Totaline

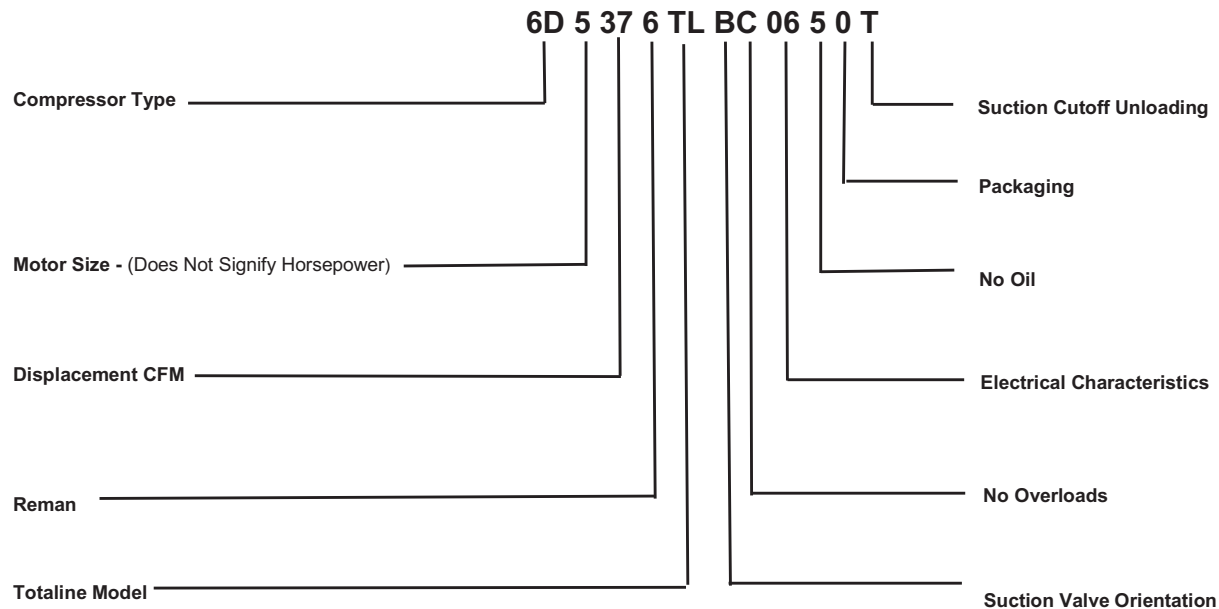

06D Semi-Hermetic Compressor Data

HIGH TEMP, SUCTION CUT OFF, THREE PHASE											
MODEL NO	Totaline Model	VOLTS	PH	HZ	HP	CYL	OIL CHG (PINTS)	MAX WATTS	MAX RLA	MTA	LRA
06DS136AC3150		575	3	60	5	4	5	6250	6.9	10.8	40
06DS136AC3650		400/460	3	50/60	5	4	5	5,200/6,250	10.8/8.6	13.5	50
06DS136AC3250		208/230	3	60	5	4	5	6250	17.3	27	100
06DS8186AC3150	6DM8186TLAC0150	575	3	60	6.5	4	7	10800	11.3	17.6	64
06DS8186AC3650	6DM8186TLAC0650	400/460	3	50/60	6.5	4	7	9,000/10,800	15.7/14.1	22	80
06DS8186AC3250	6DM8186TLAC1250	208/230	3	60	6.5	4	7	10800	28.2	44	160
06DS8246AC3150		575	3	60	7.5	6	10	12800	14.2	22	79
06DS8246AC3650		400/460	3	50/60	7.5	6	10	10,700/12,800	19.9/17.8	27.8	99
06DS8246AC3250		208/230	3	60	7.5	6	10	12800	35.5	55.5	198
06DS8246BC3150	6D8246TLBC0150T	575	3	60	7.5	6	10	12800	14.2	22	79
06DS8246BC3650	6D8246TLBC0650T	400/460	3	50/60	7.5	6	10	10,700/12,800	19.9/17.8	27.8	99
06DS8246BC3250	6D8246TLBC1250T	208/230	3	60	7.5	6	10	12800	35.5	55.5	198
06DS8256BC3150		575	3	60	7.5	6	10	12800	14.2	22	79
06DS8256BC3650		460	3	60	7.5	6	10	12800	17.8	27.8	99
06DS8256BC3250		208/230	3	60	7.5	6	10	12800	35.5	55.5	198
06DS3286BC3150	6D3286TLBC0150T	575	3	60	10	6	10	16500	16	25	91
06DS3286BC3650	6D3286TLBC0650T	400/460	3	50/60	10	6	10	13,700/16,500	22.1/19.9	31	114
06DS3286BC3250	6D3286TLBC1250T	208/230	3	60	10	6	10	16500	39.7	62	228
06DS5376BC0150	6D5376TLBC0150T	575	3	60	15	6	10	20700	20.5	32	96
06DS5376BC0650	6D5376TLBC0650T	400/460	3	50/60	15	6	10	17,200/20,700	32/25.6	40	120
06DS5376BC1250	6D5376TLBC1250T	208/230	3	60	15	6	10	20700	57.1	89	266

Semi-Hermetic Compressors

Compressor Model Number Significance 06E COMPRESSORS

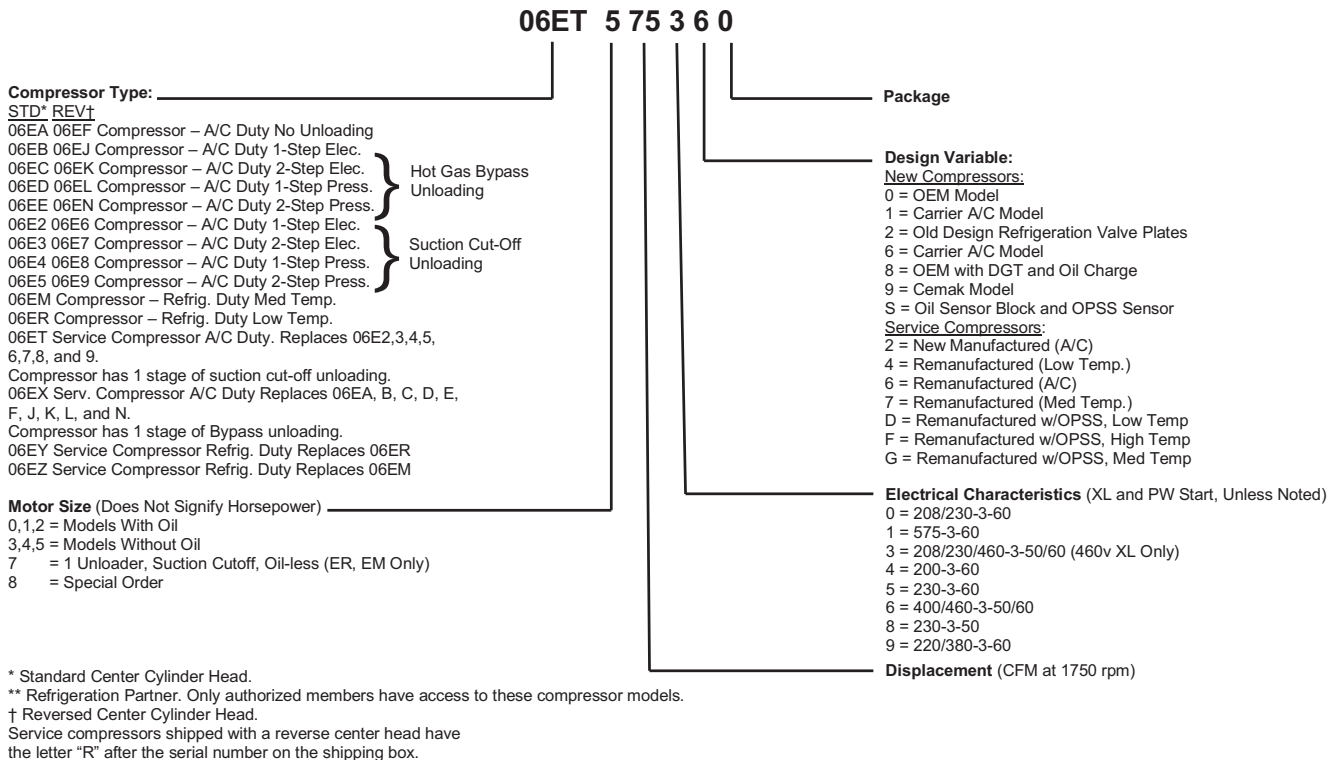

Compressor Model Number Significance 6E Totaline

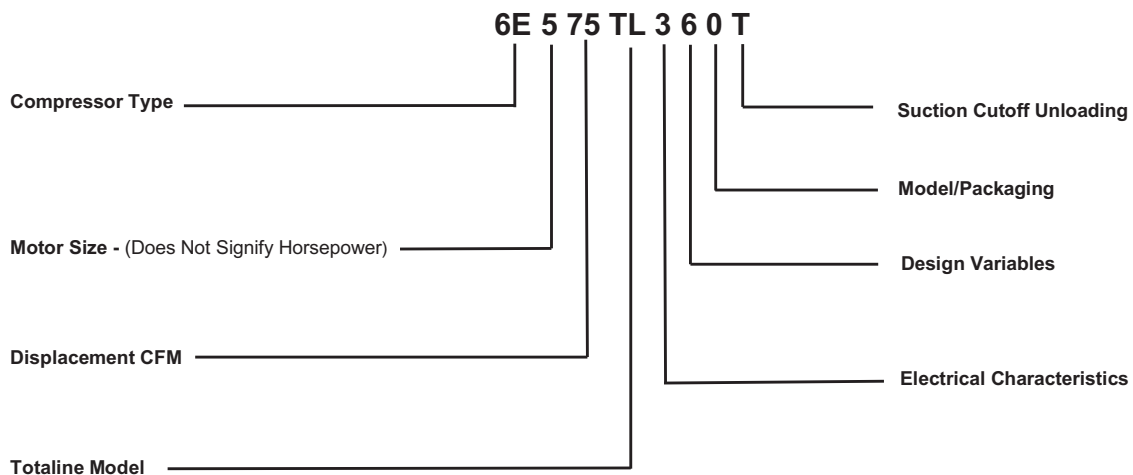

Semi-Hermetic Compressors

06E Compressor Data

HIGH EFFICIENCY, SUCTION CUTOFF											
MODEL NO	Totaline Model	VOLTS	PH	HZ	HP	CYL	OIL CHG (PINTS)	MAX WATTS	MAX RLA	MTA	LRA
06ET450360	6E450TL360T	208-230/460	3	60	15	4	14	22,000	72/36	90/46	283/142
06ET450660 PW		460	3	60	15	4	14	22,000	36.0	46.0	142
06ET550160	6E550TL160T	575	3	60	20	4	14	25,300	36	45	120
06ET550360	6E550TL360T	208-230/460	3	60	20	4	14	25,300	87/44	108/54	345/173
06ET550660 PW		460	3	60	20	4	14	25,300	44	54	173
06ET450360		200/400	3	50	15	4	14	18,300	72/36	90/46	283/142
06ET450660 PW		400	3	50	15	4	14	18,300	36	46	142
06ET550360	6E550TL360T	200/400	3	50	20	4	14	21,100	87/44	108/54	345/173
06ET550660 PW		400	3	50	20	4	14	21,100	44	54	173
06ET565160		575	3	60	25	6	19	33,600	46	57	164
06ET565360	6E565TL360T	208-230/460	3	60	25	6	19	33,600	112/56	140/70	446/223
06ET565360 R	6E565TL360TR	208-230/460	3	60	25	6	19	33,600	112/56	140/70	446/223
06ET565660 PW		460	3	60	25	6	19	33,600	56	70	223
06ET475360	6E475TL360T	208-230/460	3	60	25	6	19	33,600	112/56	140/70	446/223
06ET475360 R	6E475TL360TR	208-230/460	3	60	25	6	19	33,600	112/56	140/70	446/223
06ET475660 PW		460	3	60	25	6	19	33,600	56	70	223
06ET575160	6E575TL160T	575	3	60	30	6	19	39,100	52	65	176
06ET575360	6E575TL360T	208-230/460	3	60	30	6	19	39,100	135/68	168/84	506/253
06ET575360 R	6E575TL360TR	208-230/460	3	60	30	6	19	39,100	135/68	168/84	506/253
06ET575660 PW		460	3	60	30	6	19	39,100	68	84	253
06ET599160		575	3	60	40	6	19	54,000	75	94	276
06ET599360	6E599TL360T	208-230/460	3	60	40	6	19	54,000	189/95	236/118	690/345
06ET599360 R	6E599TL360TR	208-230/460	3	60	40	6	19	54,000	189/95	236/118	690/345
06ET599660 PW		460	3	60	40	6	19	54,000	95	118	345
06ET565360	6E565TL360T	200/400	3	50	25	6	19	28,000	112/56	140/70	446/223
06ET565660 PW		400	3	50	25	6	19	28,000	56	70	223
06ET475360	6E475TL360T	200/400	3	50	25	6	19	28,000	112/56	140/70	446/223
06ET475660 PW		400	3	50	25	6	19	28,000	56	70	223
06ET575360	6E575TL360T	200/400	3	50	30	6	19	32,600	135/68	168/54	506/253
06ET575660 PW		400	3	50	30	6	19	32,600	68	84	253
06ET599360	6E599TL360T	200/400	3	50	40	6	19	45,000	189/95	236/118	690/345
06ET599660 PW		400	3	50	40	6	19	45,000	95	118	345

"R" suffix designates Reverse Head • "PW" suffix designates Part Wind Compressor

Genuine Carlyle Compressors... Quality, Dependability, and Safety!

Semi-Hermetic Compressors

GENUINE CARLYLE REMANUFACTURED COMPRESSORS

NOW SHIPPING WITHOUT OIL

All factory production of Genuine Carlyle Remanufactured 06D and 06E compressors has converted to oil-less condition.

Because there is still inventory of oil-*filled* units – your inventory and factory inventory – different model numbers will convert from oil-filled to oil-less at different points in time.

Use the guide below to identify which models are oil-less.

For oil-less models, use the information on page 2 of this document to assure that your customer has the oil they need to complete the job.



0 6 D R 3 3 7 0 D A 3 6 5 A
 1 2 3 4 5 6 7 8 9 10 11 12 13 14

06D - 13th digit = "5", compressor ships WITHOUT oil



0 6 E R 5 9 9 3 0
 0 6 E R 4 9 9 3 0
 1 2 3 4 5 6 7 8 9

06E - 5th digit = "4" or "5", compressor ships WITHOUT oil



Replacement Components offers refrigeration oil in various types and quantities.

Ask your customers if they have the they oil they need to complete every job with a Genuine Carlyle Remanufactured compressor.

06D model digits 6 & 7 06E model digits 6 & 7 Compressor Size (Displacement)	Oil Quantity Required Pints of Oil
08	3
13	4.5
18	5.5
24, 25, 28, 37	8
50, 66	14
65, 75, 99	19

Oil Type	RC Part numbers			
	1 Quart	1 Gallon	5 gallons	55 Gallons
Mineral Oil 150, for R-22	P903-0125	P903-0101	P903-0105	P903-0155
Alkybenzene Oil 150, for R-22	P903-2025	P903-2001	P903-2005	n/a
POE68 Oil, for R-507, R-404A, R-407C, R-134a	P903-1025	P903-1001	P903-1005	n/a
POE68e Oil, for R-507, R-404A, R-407C	P903-1725	P903-1701	P903-1705	n/a



www.CarlyleCompressor.com | 1-800-GoCarlyle | © Carrier Corp. | 575-060

Semi-Hermetic Compressors

Totaline® Remanufactured Semi-Hermetic Compressors

When you need a reliable standard efficiency compressor at a competitive price, there's only one place to turn. Totaline® remanufactured Compressors have all the features you need at a price that can't be beat.

- A no-hassle warranty that's backed by Carrier Corporation, the world's largest manufacturer of air conditioning products
- Built to the exact Totaline remanufacturing specifications set by engineers at Carrier Corporation
- Suction cut off unloading capability
- Standard efficiency motor
- Standard efficiency primary running gear
- Dual and triple voltage
- Brand new critical wearing parts
- Electrical components upgraded to the latest design standards
- Electrical components meet UL standards
- All Totaline compressors are run-tested
- Electrical testing of motor insulation checked at 1000 volts plus 2x nameplate voltage

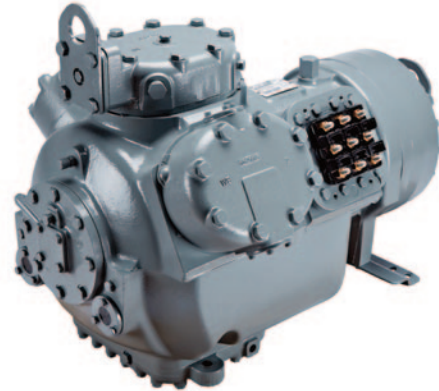

MODEL NUMBER	VOLTAGE
6D5376TLBC0650T	460
6DM8186TLAC0150	575
6D8246TLBC0150T	575
6D3286TLBC0150T	575
6D5376TLBC1250T	208/230
6DM8186TLAC1250	208/230
6D8246TLBC1250T	208/230
6D3286TLBC1250T	208/230
6D5376TLBC1250T	208/230
6DM8186TLAC0650	400/460
6D8246TLBC0650T	400/460
6D3286TLBC0650T	400/460
6E450TL360T	208/230/460
6E475TL360T	208/230/460
6E475TL360TR	208-230/460
6E550TL160T	575
6E550TL360T	208/230/460
6E565TL360T	208/230/460
6E565TL360TR	208-230/460
6E575TL160T	575
6E575TL360T	208/230/460
6E575TL360TR	208-230/460
6E599TL360T	208/230/460
6E599TL360TR	208-230/460

*Totaline Remanufactured (not Rebuilt) Compressors Give Good as New,
If Not Better than New Performance!*

Semi-Hermetic Compressors

Compressor Model Number Significance 06CY COMPRESSORS

06CY 0 16 CG 103

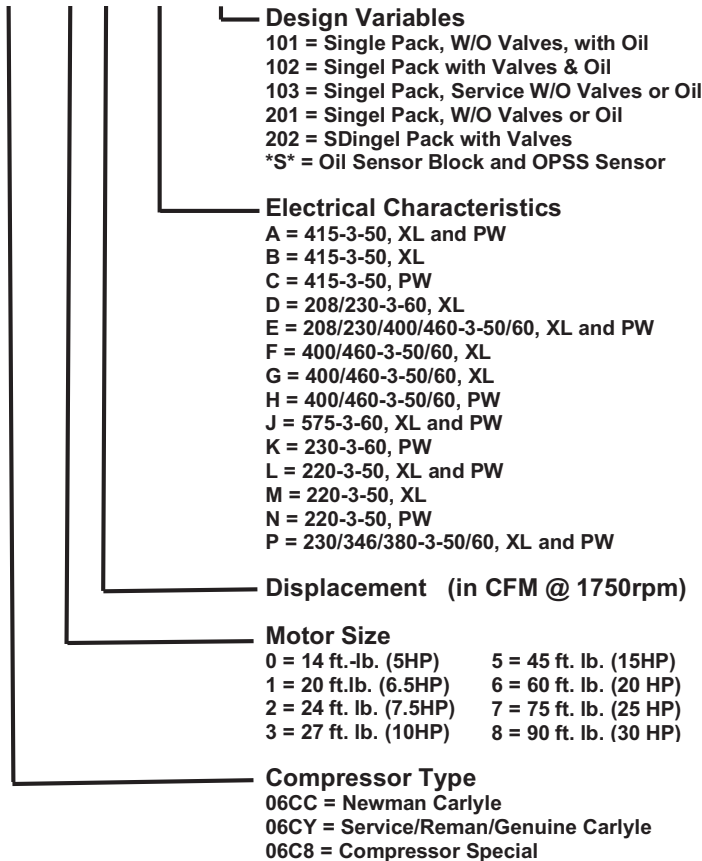

MOST POPULAR 06CY COMPRESSOR

MODEL NUMBER	CFM	VOLTAGE/PH	HZ
06CY 016 G 103	16	400/460-3	50/60 HZ
06CY 018 G 103	18	400/460-3	50/60 HZ
06CY 124 G 103	24	400/460-3	50/60 HZ
06CY 228 G 103	28	400/460-3	50/60 HZ
06CY 337 G 103	37	400/460-3	50/60 HZ
06CY 550 E 103	50	208/230/400/460-3	50/60 HZ
06CY 665 E 103	65	208/230/400/460-3	50/60 HZ
06CY 675 E 103	75	208/230/400/460-3	50/60 HZ
06CY 675 F 103	75	400/460-3	50/60 HZ
06CY 899 E 103	99	208/230/400/460-3	50/60 HZ

Semi-Hermetic Compressors

LIQUID INJECTION/DESUPERHEATING VALVES FOR O6CY COMPRESSORS	
MODEL NUMBER	DESCRIPTION
EA02ZD001	1 ton, 190 F, 30"
EA02ZD002	1-1/2 ton, 190 F, 5'
EA02ZD005	1/2 ton, 190 F, 5'
EA02ZD100	5 ton, 190 F, 5'
EA11ZC010	1/2 ton, 250 F, 5'
EA11ZC011	1/2 ton, 230 F, 5'
EA11ZC020	1 ton, 250 F, 5'
EA11ZC022	1 ton, 230 F, 5'
EA11ZC030	1-1/2 ton, 230 F, 5'
EA680045	3 ton, 190 F, 5'

Compressor Model Number Significance 5F& 5H COMPRESSORS

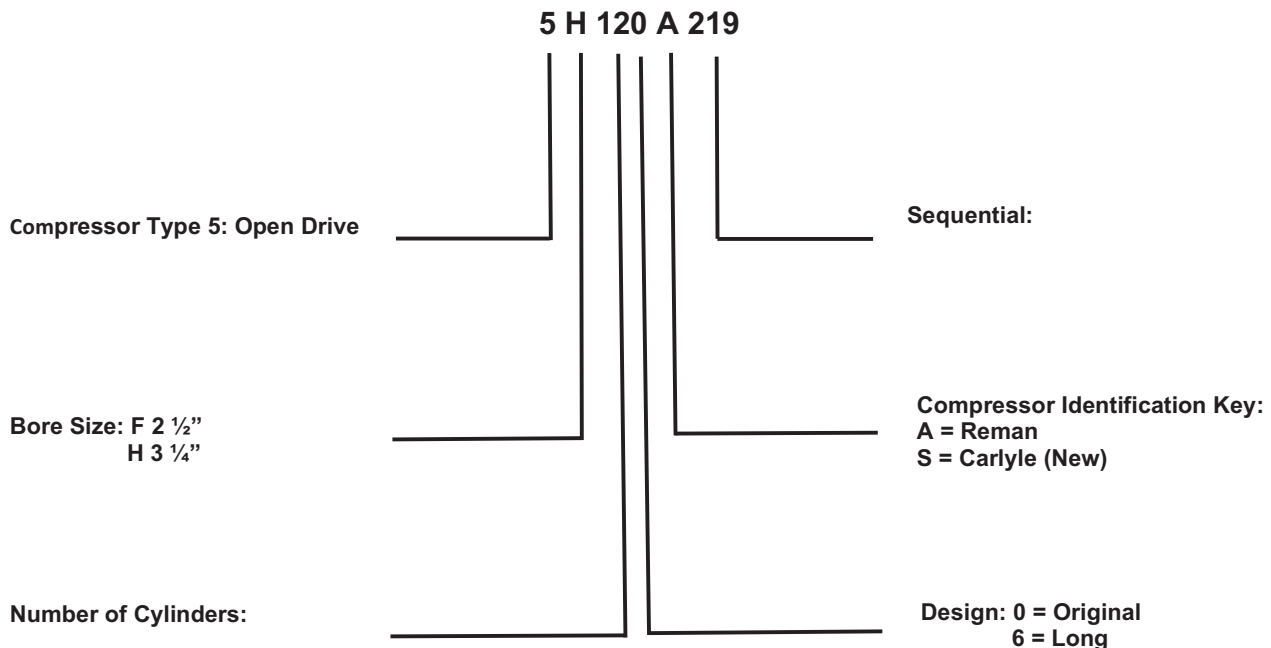

Semi-Hermetic Compressors

5F & 5H Open Drive Compressor Data

5F & 5H OPEN DRIVE COMPRESSOR DATA															
MODEL NO	NOMINAL HORSEPOWER			# OF CYL	BORE (in)	STROKE (in)	CFM @ 1750 RPM	RATINGS IN TONS*			MIN SPEED FOR UNLOADER OPERATION	OIL CHG (Pints)	SUCTION LINE ODF (in)	DISCH LINE ODF (in)	CMPR WGT (lb)
	134a	R-22	R-407c					R-22	R-134a	R-407c					
5F20A189	6	10	8.8	2	2-1/2	2	19.8	8.5	5.2	8.2	600	5	1-1/8	7/8	175
5F30A189 or 219	9	15	13	3	2-1/2	2	29.8	12.7	7.8	12.3	700	5-1/2	1-5/8	1-3/8	215
5F40219	11.5	20	17.3	4	2-1/2	2	39.8	16.8	10.5	16.3	800	12	1-5/8	1-3/8	355
5F60219	17	25	26	6	2-1/2	2	59.6	25.6	15.7	24.6	900	13	2-1/8	1-5/8	400
5H40-(+)219	27.5	40	39.5	4	3-1/4	2-3/4	92.4	39.6	24.7	38.4	800	18	2-5/8	2-1/8	610
5H46-(+)219	35.4	60	51.4	4	3-1/4	3-7/16	115.5	49.1	30.6	47.5	800	18	2-5/8	2-1/8	610
5H60-(+)219	40.8	60	59	6	3-1/4	2-3/4	138.4	59.4	37.0	57.6	900	21	3-1/8	3-1/8	795
5H66-(+)219	53	75	76.8	6	3-1/4	3-7/16	173.0	73.8	45.9	71.4	900	21	3-1/8	3-1/8	795
5H80-(+)219	54.6	75	78.4	8	3-1/4	2-3/4	184.7	79.2	49.5	76.8	1100	41	3-1/8	3-1/8	1115
5H86-(+)219	70.5	100	102	8	3-1/4	3-7/16	231.0	98.2	61.1	95.3	1100	41	3-1/8	3-1/8	1115
5H120-(+)219	80.5	125	117.1	12	3-1/4	2-3/4	276.0	119.0	74.0	115.3	900	61	4-1/8	4-1/8	1580
5H126-(+)219	101.4	150	152.3	12	3-1/4	3-7/16	346.0	149.0	91.8	143.0	900	61	4-1/8	4-1/8	1580

(+) = either "A" (remanufactured) or "S" (New Manufactured – only 5H)

NOTES:

- *40° F saturated suction, 105° F saturated discharge, 15° F superheat, 0° F sub-cooling.
- 45 PSIG net oil pressure (oil pressure PSIG - suction pressure PSIG).
- ODF = Outside Diameter Female (in.).
- Maximum RPM = 1750.
- Minimum RPM for lubrication = 400 RPM.
- Must use oil cooler on long stroke models:
5H46, 5H66, 5H86, 5H126 (see Accessory page for oil cooler part number)
- Not rated for R-410A



5F & 5H Compressor Models Available

5F/5H COMPRESSOR
COMPRESSOR PART#
5F20-A189
5F30-A219
5F40-A219
5F60-A219
5H40-(+)219
5H46-(+)219

5H COMPRESSOR MODELS
COMPRESSOR PART#
5H60-(+)219
5H66-(+)219
5H80-(+)219
5H86-(+)219
5H120-(+)219
5H126-(+)219

(+) = either "A" (remanufactured) or "S" (New Manufactured - only 5H).
For R404A/R507A application data, contact RCD.

Build Your Reputation On Our Reliability!
Carlyle Open Drive Compressors Stand the Test of Time.

Semi-Hermetic Compressors

Compressor Model Number Significance 06N SCREW COMPRESSORS

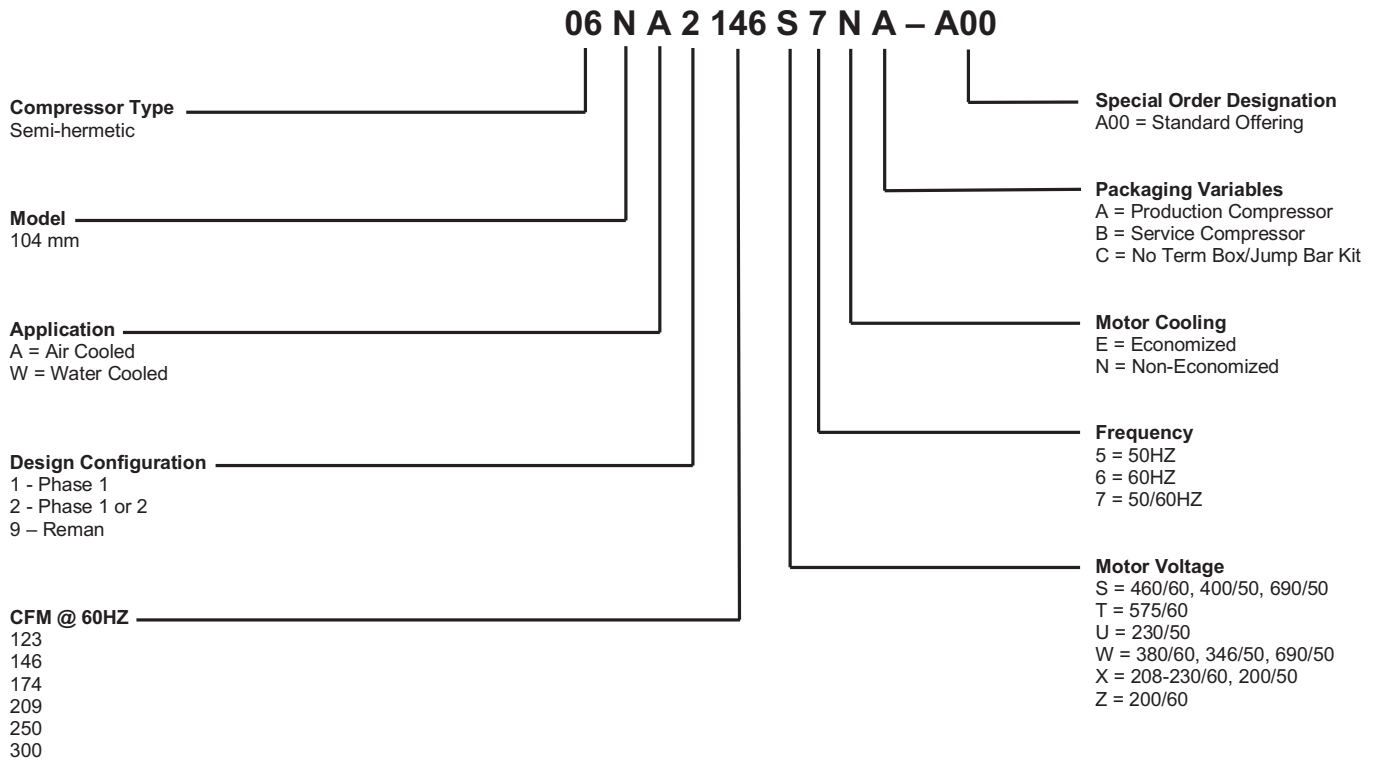

MOST POPULAR 06N SCREW COMPRESSOR			
MODEL NUMBER	CFM	VOLTAGE/PH	HZ
06NA2146 S7NA	146	400/460-3	50/60 HZ
06NW2174 S7NA	174	400/460-3	50/60 HZ
06NW2209 S7NA	209	400/460-3	50/60 HZ
06NA2209 S7EA	209	400/460-3	50/60 HZ
06NW2209 S7EA	209	400/460-3	50/60 HZ
06NW2209 X7NA	209	208-230/200-3	50/60 HZ
06NA2209 X7NA	209	208-230/200-3	50/60 HZ
06NW2250 S7EA	250	400/460-3	50/60 HZ
06NA2250 S7EA	250	400/460-3	50/60 HZ
06NW2250 S7NA	250	400/460-3	50/60 HZ

Semi-Hermetic Compressors

Compressor Model Number Significance 06T SCREW COMPRESSORS

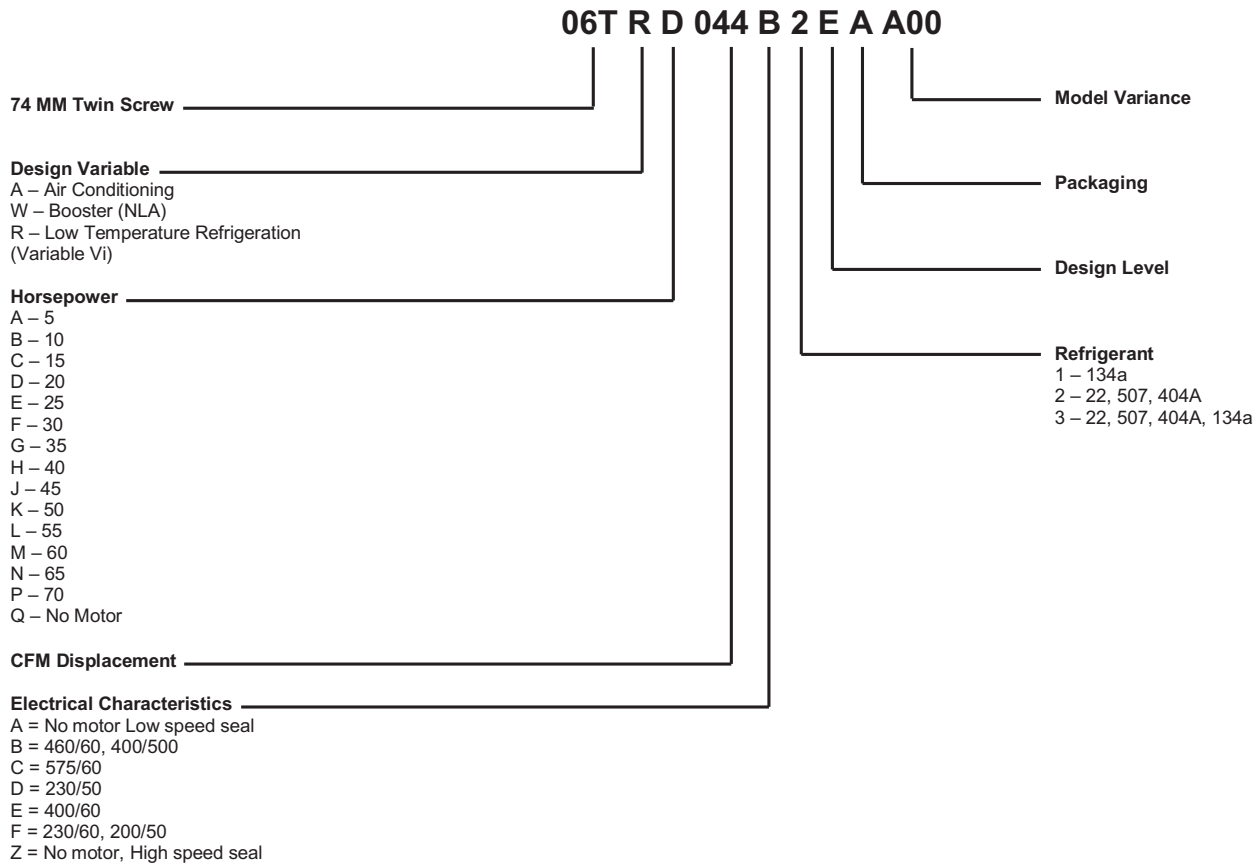

MOST POPULAR 06T SCREW COMPRESSOR			
MODEL NUMBER	CFM	VOLTAGE/PH	HZ
06TRD044B2EA-A00	44	400/460-3	50/60 HZ
06TAF048B2EA-A00	48	400/460-3	50/60 HZ
06TAG054B2EA-A00	54	400/460-3	50/60 HZ
06TRE054B2EA-A00	54	400/460-3	50/60 HZ
06TRF065B2EA-A00	65	400/460-3	50/60 HZ
06TAG065B2EA-A00	65	400/460-3	50/60 HZ
06TRG078B2EA-A00	78	400/460-3	50/60 HZ
06TAH078B2EA-A00	78	400/460-3	50/60 HZ
06TRH088B2EA-A00	88	400/460-3	50/60 HZ
06TAK088B2EA-A00	88	400/460-3	50/60 HZ

Compressors Accessories

Crankcase Heaters for 06D & 06E Accessories

CRANKCASE HEATER PACKAGE				
PART#	VOLTS	WATTS LENGTH (Inches)	CONDUIT (Inches)	WIRE LENGTH
06EA660165	115	180	19	24
06EA660167	115	180	52	73
06EA660166	230	180	19	24
06EA660168	230	180	52	73
06EA660107	120	125	52	73
06EA660108	240	125	52	73
06DA660076	480	125	NONE	24

New straight tube heater design.

Package contains: Crankcase Heater, Retainer Clip and Anti-short Bushing, and Heat Conducting Grease (p/n: 38AQ680001).

Capacity Control Valves

CAPACITY CONTROL VALVES	
PART#	TYPE
06DA660176	PRESSURE
06DA660175	ELECTRIC
EF19ZZ001	24V COIL
EF19ZZ002	120V COIL
EF19ZZ003	208/240V COIL

*Protect your new compressor from future damage.
Install a new crankcase heater
with every compressor replacement.*



Unloaders Increase System Efficiency

Compressors Accessories

Bearing Head & Oil Pump

BEARING HEAD & OIL PUMP	
PART#	USED ON
06DA660126	06D
06EA660157	06E

Figure 3 – Bearing Head & Oil Pump Assembly



Valve Plates

VALVE PLATES	
PART#	USED ON
06DA660152	06DM, 06DS
06DA660151	06DR
06EA660137	06EM, 06ET, 06EZ
06EA660143	06ER, 06EY
06ER660017	06ER, 06EY, Very Low Temp

Figure 4 – Valve Plates

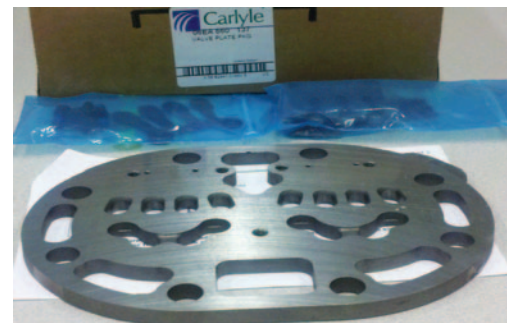

Hermetic/Semi-Hermetic Compressor Accessories

CRANKCASE HEATERS	
PART#	CRANKCASE HEATERS
P041-4443	25" 240V
P041-4423	35" 240V
P041-4444	25" 460V
P041-4441	35" 460V
06EA660167	180 W 115V FOR 06E & 06D COMPRESSORS
06EA660168	180 W 230V FOR 06E & 06D COMPRESSORS
06DA660076	125 W 480V FOR 06E & 06D COMPRESSORS



COMPRESSOR MISC	
PART#	COMPRESSOR MISC
060B210966	OIL SWITCH 1/4" MALE FLARE
060B2164	OIL SWITCH 3/8" CAP TUBE 1/4" MALE FLARE
EP23LC090	ANGLED OIL DRAIN VALVE
DE14CA126	ANGLED VALVE ADAPTOR
PH23QK016	SEA FOAM GREEN TOUCH UP PAINT
P298-001	COMPRESSOR PLUG KIT
T133300B-1	SIGHT GLASS TOOL

CARRIER/BRYANT/PAYNE	
PART#	R-410A LIQUID LINE DRIERS
KH43LG072	16 Cu In 3/8 Heat Pump
KH43LG074	16 Cu In 3/8 A/C

Genuine Carlyle Replacement Parts

Compressors Accessories

Totalline® Aftermarket Filter-Driers

Bi-Flow

Bi-Flow DRIERS - SWEAT CONNECTION				
PART NO.	APPL	CU. IN.	CONN.	STYLE
P504-H083S	Bi-Flow	8	3/8"	Solid Core
P504-H084S	Bi-Flow	8	1/2"	Solid Core
P504-H163S	Bi-Flow	16	3/8"	Solid Core
P504-H164S	Bi-Flow	16	1/2"	Solid Core
P504-H165S	Bi-Flow	16	5/8"	Solid Core

Bi-Flow DRIERS - FLARE CONNECTION				
PART NO.	APPL	CU. IN.	CONN.	STYLE
P504-H163	Bi-Flow	16	3/8"	Solid Core

Liquid Line

Liquid Line DRIERS - SWEAT CONNECTION				
PART NO.	APPL	CU. IN.	CONN.	STYLE
P502-8032S	Liquid Line	3	1/4"	Loose Bead
P502-8052S	Liquid Line	5	1/4"	Loose Bead
P502-8053S	Liquid Line	5	3/8"	Loose Bead
P502-8082S	Liquid Line	8	1/4"	Loose Bead
P502-8083S	Liquid Line	8	3/8"	Loose Bead
P502-8162S	Liquid Line	16	1/4"	Loose Bead
P502-8163S	Liquid Line	16	3/8"	Loose Bead
P502-8164S	Liquid Line	16	1/2"	Loose Bead
P502-8165S	Liquid Line	16	5/8"	Loose Bead
P502-8303S	Liquid Line	30	3/8"	Loose Bead
P502-8304S	Liquid Line	30	1/2"	Loose Bead
P502-8305S	Liquid Line	30	5/8"	Loose Bead
P502-8306S	Liquid Line	30	3/4"	Loose Bead
P502-8307S	Liquid Line	30	7/8"	Loose Bead
P502-8309S	Liquid Line	30	1-1/8"	Loose Bead
P502-C032S	Liquid Line	3	1/4"	Solid Core
P502-C052S	Liquid Line	5	1/4"	Solid Core
P502-C053S	Liquid Line	5	3/8"	Solid Core
P502-C082S	Liquid Line	8	1/4"	Solid Core
P502-C083S	Liquid Line	8	3/8"	Solid Core
P502-C162S	Liquid Line	16	1/4"	Solid Core
P502-C163S	Liquid Line	16	3/8"	Solid Core
P502-C164S	Liquid Line	16	1/2"	Solid Core
P502-C165S	Liquid Line	16	5/8"	Solid Core
P502-C303S	Liquid Line	30	3/8"	Solid Core
P502-C304S	Liquid Line	30	1/2"	Solid Core
P502-C305S	Liquid Line	30	5/8"	Solid Core
P502-C306S	Liquid Line	30	3/4"	Solid Core
P502-C307S	Liquid Line	30	7/8"	Solid Core
P502-C309S	Liquid Line	30	1-1/8"	Solid Core

Liquid Line

Liquid Line DRIERS - FLARE CONNECTION				
PART NO.	APPL	CU. IN.	CONN.	STYLE
P502-8032	Liquid Line	3	1/4"	Loose Bead
P502-8052	Liquid Line	5	1/4"	Loose Bead
P502-8053	Liquid Line	5	3/8"	Loose Bead
P502-8082	Liquid Line	8	1/4"	Loose Bead
P502-8083	Liquid Line	8	3/8"	Loose Bead
P502-8162	Liquid Line	16	1/4"	Loose Bead
P502-8163	Liquid Line	16	3/8"	Loose Bead
P502-8164	Liquid Line	16	1/2"	Loose Bead
P502-8165	Liquid Line	16	5/8"	Loose Bead
P502-8303	Liquid Line	30	3/8"	Loose Bead
P502-8304	Liquid Line	30	1/2"	Loose Bead
P502-8305	Liquid Line	30	5/8"	Loose Bead
P502-C032	Liquid Line	3	1/4"	Solid Core
P502-C052	Liquid Line	5	1/4"	Solid Core
P502-C053	Liquid Line	5	3/8"	Solid Core
P502-C082	Liquid Line	8	1/4"	Solid Core
P502-C083	Liquid Line	8	3/8"	Solid Core
P502-C162	Liquid Line	16	1/4"	Solid Core
P502-C163	Liquid Line	16	3/8"	Solid Core
P502-C164	Liquid Line	16	1/2"	Solid Core
P502-C165	Liquid Line	16	5/8"	Solid Core
P502-C303	Liquid Line	30	3/8"	Solid Core
P502-C304	Liquid Line	30	1/2"	Solid Core
P502-C305	Liquid Line	30	5/8"	Solid Core

Suction Line

Suction Line DRIERS - SWEAT CONNECTION				
PART NO.	APPL	CU. IN.	CONN.	STYLE
P503-C165S	Suction Line	16	5/8"	Solid Core
P503-C166S	Suction Line	16	3/4"	Solid Core
P503-C167S	Suction Line	16	7/8"	Solid Core
P503-C305S	Suction Line	30	5/8"	Solid Core
P503-C306S	Suction Line	30	3/4"	Solid Core
P503-C307S	Suction Line	30	7/8"	Solid Core
P503-C309S	Suction Line	30	1-1/8"	Solid Core
P503-C419S	Suction Line	41	1-1/8"	Solid Core

***We also have P505-8 Liquid & Suction Line Replaceable Shell series, P506-8 Universal Filter Drier Core series, P507-8 Premium Suction Line Filter Drier series and P508-8 Liquid Line Burnout Filter Drier series available.*

Compressors Accessories

Totaline® Universal TXV Kits

Totaline® Universal TXV Nomenclature

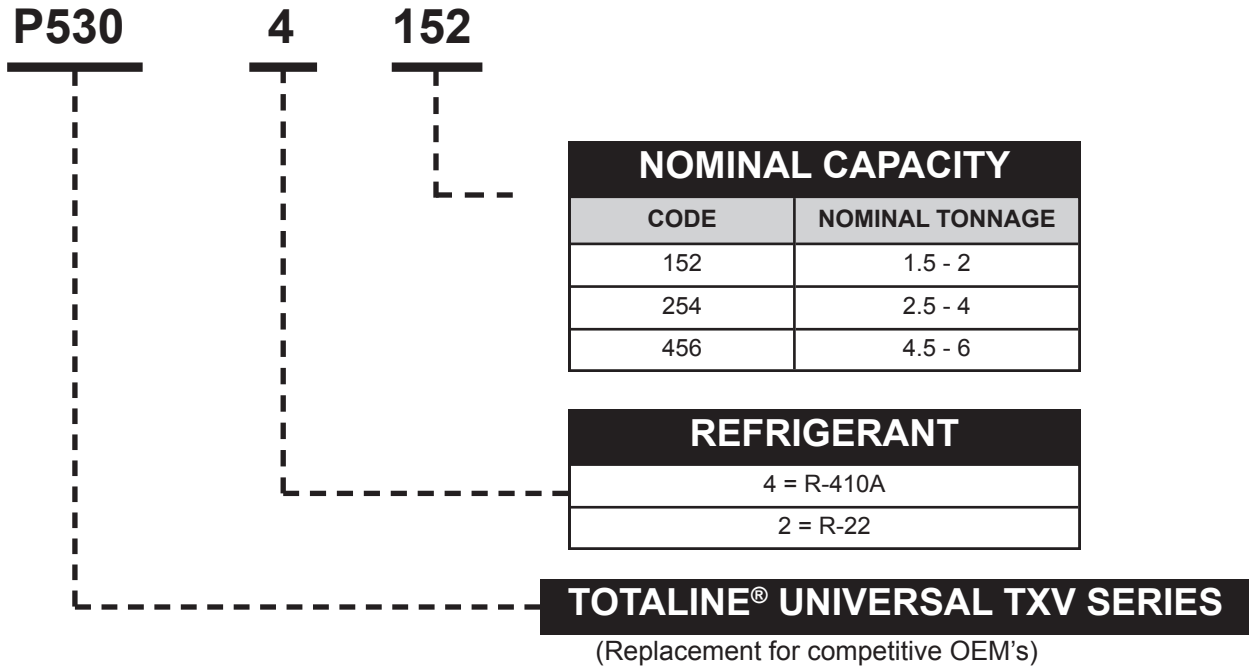

Totaline® Part Numbers

R-410A		
TXV Size	Covers Unit Sizes	Totaline P/N
2 ton	1.5 ton – 2 ton	P530-4152
4 ton	2.5 ton – 4 ton	P530-4254
6 TON	4.5 ton – 6 ton	P530-4456

R-22/R-407C		
TXV Size	Covers Unit Sizes	Totaline P/N
2 ton	1.5 ton – 2 ton	P530-2152
4 ton	2.5 ton – 4 ton	P530-2254
6 TON	4.5 ton – 6 ton	P530-2456

Aftermarket Components for Copeland Applications (1-50 Tons)

	1.5 Ton - 2 Ton	2.5 Ton - 3 Ton	3.5 Ton - 4 Ton	4.5 Ton - 5 Ton	5 Ton - 6 Ton	6 Ton - 8 Ton
TXVs*						
R-22 part #	P530-2152	P530-2254	P530-2254	P530-2456	P530-2456	163556-A
Description	3/8 x 1/2 kit	3/8 x 1/2 kit	3/8 x 1/2 kit	3/8 x 1/2 kit	3/8 x 1/2 kit	EBSVE8GA 5/8 x 7/8
R-410A part #	P530-4152	P530-4254	P530-4254	P530-4456	P530-4456	168719-A
Description	3/8 x 1/2 kit	3/8 x 1/2 kit	3/8 x 1/2 kit	3/8 x 1/2 kit	3/8 x 1/2 kit	ERZE8GA 5/8 x 7/8
A/C Liquid Line Solenoid valve less coil						
R-22 part #**	E5S130	E6S130	E6S130	E9S230	E9S230	E10S250
Description	3/8 solenoid valve	3/8 solenoid valve	3/8 solenoid valve	3/8 solenoid valve	3/8 solenoid valve	5/8 solenoid valve
R-410A part #***	E5S130-HP	ME6S130-HP	ME6S130-HP	ME6S130-HP	ME6S130-HP	ME9S240-HP
Description	3/8 solenoid valve	3/8 solenoid valve	3/8 solenoid valve	3/8 solenoid valve	3/8 solenoid valve	1/2 solenoid valve
A/C Solenoid Coil (R-22 / R-410A)						
MKC-1 or MKC-2	MKC-1	MKC-1	MKC-1	MKC-2	MKC-2	MKC-2
24 v part #	MKC-124/50-60JQAQ	MKC-124/50-60JQAQ	MKC-124/50-60JQAQ	MKC-224/50-60JQAQ	MKC-224/50-60JQAQ	MKC-224/50-60JQAQ
120 v part #	MKC-1120/50-60JAM	MKC-1120/50-60JAM	MKC-1120/50-60JAM	MKC-2120/50-60JAM	MKC-2120/50-60JAM	MKC-2120/50-60JAM
208-240 v part #	310156-A	310156-A	310156-A	311515-A	311515-A	311515-A
Dual voltage part #	MKC-1DUALJAU	MKC-1DUALJAU	MKC-1DUALJAU	MKC-2DUALJAU	MKC-2DUALJAU	MKC-2DUALJAU
Heat Pump Liquid Line Solenoid Valve less coil						
R-22/R410A part #	ALC-066203	ALC-066203	ALC-066203	ALC-066208	ALC-066208	ALC-066208
Description	200RD3T3M 3/8 solenoid valve	200RD3T3M 3/8 solenoid valve	200RD3T3M 3/8 solenoid valve	200RD5T3M 3/8 solenoid valve	200RD5T3M 3/8 solenoid valve	200RD5T3M 3/8 solenoid valve
Bi-directional Kit (required)	ALC-066224	ALC-066224	ALC-066224	ALC-066224	ALC-066224	ALC-066224
Heat Pump Solenoid Coil						
24v part #	AMG-24/50-60	AMG-24/50-60	AMG-24/50-60	AMG-24/50-60	AMG-24/50-60	AMG-24/50-60
120v part #	AMG-120/50-60	AMG-120/50-60	AMG-120/50-60	AMG-120/50-60	AMG-120/50-60	AMG-120/50-60
208-240v part #	AMG-208-240/50-60	AMG-208-240/50-60	AMG-208-240/50-60	AMG-208-240/50-60	AMG-208-240/50-60	AMG-208-240/50-60
A/C Liquid Line Filter-Drier (for R-22 & R-410A)						
P502-8053S	P502-8053S	P502-8053S	P502-8083S	P502-8163S	P502-8304S	P502-8305S
Description	5 cu. in. 3/8 drier	5 cu. in. 3/8 drier	8 cu. in. 3/8 drier	16 cu. in. 3/8 drier	30 cu. in. 1/2 drier	30 cu. in. 5/8 drier
Heat Pump Liquid Line Filter-Drier R-22/R410A part #						
P504-H083S	P504-H083S	P504-H083S	P504-H083S	P504-H163S	BFK-304S	BFK-305S
Description	8 cu. in. 3/8 drier	8 cu. in. 3/8 drier	8 cu. in. 3/8 drier	16 cu. in. 3/8 drier	30 cu. in. 1/2 drier	30 cu. in. 5/8 drier
Sight Glass & Moisture Indicator (for R-22 & R-410A)						
HMI-1TT3	HMI-1TT3	HMI-1TT3	HMI-1TT3	HMI-1TT3	HMI-1TT3	HMI-1TT5
Description	3/8 ODF	3/8 ODF	3/8 ODF	3/8 ODF	3/8 ODF	5/8 ODF
Ball Valve (for R-22 & R-410A)						
586WAS-6ST	586WAS-6ST	586WAS-6ST	586WAS-6ST	586WAS-6ST	586WAS-6ST	586WAS-10ST
Description	3/8 with access fitting	3/8 with access fitting	3/8 with access fitting	3/8 with access fitting	3/8 with access fitting	5/8 with access fitting
Suction Line Accumulator (for R-22 & R-410A)						
KH71KK120	KH71KK120	KH71KK120 or KH71KJ141	KH71KK161	KH71KK161	089120-01	089283-00
Description	5/8 accumulator	5/8 or 3/4 accumulator	7/8 accumulator	7/8 accumulator	7/8 accumulator	1-1/8 accumulator
Replaceable Shell (for R-22 & R-410A)						
P505-8485	P505-8485	P505-8485	P505-8485	P505-8485	P505-8485	P505-8485
Description	Number of blocks - 1	Number of blocks - 1	Number of blocks - 1	Number of blocks - 1	Number of blocks - 1	Number of blocks - 1
Volume of desiccant	48 cu. in.	48 cu. in.	48 cu. in.	48 cu. in.	48 cu. in.	48 cu. in.
Connection	5/8 ODF	5/8 ODF	5/8 ODF	5/8 ODF	5/8 ODF	5/8 ODF

Note: For a superior replacement contactor for Copeland scroll compressors, use the CoreSense™ protection module, part # ESC1AFTT-CC-901.

Aftermarket Components for Competitive Applications (1-50 Tons) continued

TXVs* R-22 part # Description R-410A part # Description	Nominal Tonnage →					
	8 Ton - 12.5 Ton 163556-A (for 8 Ton) EBSVE6GA 5/8 x 7/8 124226-A (for 10 & 12.5 Ton) OVE15GA 7/8 x 1-1/8 168719-A (for 8 Ton) ERZE9GA 5/8 x 7/8 168801-A (for 10 & 12.5 Ton) ERZE12-12GA 5/8 x 7/8	12.5 Ton - 15 Ton	15 Ton - 20 Ton	20 Ton - 25 Ton	25 Ton - 35 Ton	35 Ton - 50 Ton
Solenoid valves less coil R-22 part #** Description R-410A part #*** Description	E14S250 5/8 solenoid valve ME14S250-HP 5/8 solenoid valve	E19S270 7/8 solenoid valve ME19S270-HP 7/8 solenoid valve	E25S290 1-1/8 solenoid valve ME19S270-HP 7/8 solenoid valve	E25S290 1-1/8 solenoid valve ME25S290-HP 1-1/8 solenoid valve	E25S290 1-1/8 solenoid valve ME35S190-HP 1-1/8 solenoid valve	E35S190 1-1/8 solenoid valve ME35S190-HP 1-1/8 solenoid valve
Solenoid Coil (R22** / R410A***) MKC-1 or MKC-2 24 v part # 120 v part # 208-240 v part # Dual voltage part #	MKC-2 MKC-224/50-60JAJQ MKC-2120/50-60JAM 311515-A MKC-2DUALJAU	MKC-2 MKC-224/50-60JAJQ MKC-2120/50-60JAM 311515-A MKC-2DUALJAU	MKC-2 MKC-224/50-60JAJQ MKC-2120/50-60JAM 311515-A MKC-2DUALJAU	MKC-2 MKC-224/50-60JAJQ MKC-2120/50-60JAM 311515-A MKC-2DUALJAU	MKC-2 MKC-224/50-60JAJQ MKC-2120/50-60JAM 311515-A MKC-2DUALJAU	MKC-2 MKC-124/50-60JAJQ MKC-1120/50-60JAM 311515-A MKC-1DUALJAU
Liquid Line Filter-Drier (for R-22 & R-410A)	P502-8415S 41 cu. in. 5/8 drier	P502-88757S 75 cu. in. 7/8 drier	P502-8757S 75 cu. in. 7/8 drier	P502-8759S 75 cu. in. 1-1/8 drier	P502-8759S 75 cu. in. 1-1/8 drier	P505-8489 replaceable core 1-1/8
Sight Glass & Moisture Indicator (for R-22 & R-410A)	HMI-1TT5 5/8 ODF	HMI-1TT7 7/8 ODF	HMI-1TT7 7/8 ODF	HMI-1TT9 1-1/8 ODF	HMI-1TT9 1-1/8 ODF	HMI-1TT9 1-1/8 ODF
Ball Valve (for R-22 & R-410A)	586WAS-10ST 5/8 with access fitting	587WAS-14ST 7/8 with access fitting	587WAS-14ST 7/8 with access fitting	587WAS-14ST 7/8 with access fitting	591WAS-11ST 1-1/8 with access fitting	591WAS-11ST 1-1/8 with access fitting
Replaceable Shell (for R-22 & R-410A) Volume of dessicant Connection	P505-8485 Number of blocks - 1 48 cu. in. 5/8 ODF	P505-8485 Number of blocks - 1 48 cu. in. 5/8 ODF	P505-8485 Number of blocks - 1 48 cu. in. 5/8 ODF	P505-8487 Number of blocks - 1 48 cu. in. 7/8 ODF	P505-8487 Number of blocks - 1 48 cu. in. 7/8 ODF	P505-8489 Number of blocks - 1 48 cu. in. 1-1/8 ODF

Totaine P506-8 Series Filter-Drier Cores	Recommended Refrigerant					
	Sporlan	Parker	Emerson	Henry	Danfoss	Application
P506-8D48	RC-4864	PCK-48	D-48	848-C	-	CFC, HCFC, HFC High moisture, acid, sludge, & particle
P506-8H48	RCW-4864, RCW-48	PCX-48, Z-48	H48, HX-48	848-C	48-DN, 48-DU	POE oils only Higher moisture, acid removal
P506-8W48	RC-4864-HH, RCW-100	PCK-48HH	W48	848-CM	48-DA	CFC, HCFC, HFC Burn out with charcoal
P506-8H100	RCW-100	PCK-100	H-100	-	-	POE oils only Higher moisture, acid removal
P506-8W100	RC-10098-H	-	UK-100, W-100-HH	-	-	CFC, HCFC, HFC Burn out with charcoal
P506-8RD48	-	-	-	-	-	Reclaim use only High acid removal
P506-8RH48	-	-	-	-	-	Reclaim use only High acid & water removal
P506-8RW48	-	-	-	-	-	Reclaim use only Burn out with charcoal

* All expansion valves are balance ported
 ** R-22 solenoids have extended "E" connections
 *** R-410A solenoids have extended "E" connections and "M" manual lift stem
 • Selection of components based on A/C applications at rated conditions.
 • All tonnages are nominal. R-22 selections are based on: 40°F Evaporator Temperature, 110°F Condensing Temperature, 100°F Liquid Temperature, Distributor and High Side Pressure Drop of 42 psi

They say... a picture is worth a thousand words.



This one says "we have it" at your local Totaline® Sales Center.



Totaline Sales Centers are the quick stop for your list of hermetic and semi-hermetic compressors, offering a complete lineup including Genuine Carlyle, Totaline, Copeland, Danfoss, Tecumseh, LG, Maneurop, Goldstar, Toshiba, Panasonic and Hitachi. No matter what OEM equipment you're using we have the compressor you're looking for.

To find the locations of your local Totaline Sales Centers, please visit www.rchvacparts.com