



Raychem

RESIDENTIAL & LIGHT COMMERCIAL SELF-REGULATING HEATING PRODUCTS APPLICATION AND DESIGN GUIDE

TABLE OF CONTENTS

Introduction	2
Heating Cables Selection Guide	2
Product Line	3
Accessories	5
Technical Information	6
Pipe Freeze Protection	8
WinterGard 120-V heating cable Metal or plastic piping up to 2 inches in diameter in dry locations	8
WinterGard Plus heating cable in dry locations Large piping up to 6 inches in diameter	9
WinterGard Wet heating cable in wet locations	10
FrostGuard or Gardian preassembled heating cable Pipe runs up to 100 feet, up to 2 1/2 inches in diameter	11
Designing a Cut-to-Length Pipe Freeze Protection System	12
How to design your WinterGard pipe freeze protection system	12
Preassembled Heating Cable Design on Pipes	18
How to design your FrostGuard or Gardian pipe freeze protection system	18
Roof and Gutter De-Icing	20
De-ice roofs and gutters with WinterGard Wet, FrostGuard or Gardian heating cables	20

Designing a Roof and Gutter De-Icing System with WinterGard Wet Heating Cables	22
How to design your roof and gutter de-icing system	22
Designing a Roof and Gutter De-Icing System with 120-V FrostGuard or Gardian Preassembled Heating Cables	26
How to design your roof and gutter de-icing system for smaller jobs	26
Refrigeration Applications	29
WinterGard Plus heating cable Plastic and other pipes in dry locations	30
WinterGard Wet heating cable Wet locations	31
FreezGuard self-regulating crankcase heaters for refrigeration compressors Prolong motor life and increase compressor efficiency	32
General Information	34
Product Data Table	34

INTRODUCTION

Raychem residential and light commercial self-regulating heating products are the ideal solution for pipe freeze protection, roof and gutter de-icing and crankcase heating applications. These products include WinterGard, WinterGard Plus and WinterGard Wet cut-to-length heating cable systems, FrostGuard and Gardian preassembled heating cables, and FreezGuard crankcase heaters. This application and design guide applies to these Raychem heating products only and is intended to assist in the selection of the appropriate heating cable, connection kits and accessories. Following the recommendations in this guide and those of your Pentair Thermal Building Solutions representative will result in the selection of a reliable and energy-efficient system.

HEATING CABLES SELECTION GUIDE

Application	WinterGard	WinterGard Plus	WinterGard Wet	FrostGuard 120 V	FrostGuard 240 V	Gardian 120 V	Gardian 240 V	FreezGuard
Freeze Protection								
Pipes in dry areas	•	•	•	•	•	•	•	
Pipes in wet areas			•	•	•	•	•	
Roof and Gutter De-icing			•	•		•		
Crankcase Heating								•

PRODUCT LINE

120 Volt, 3 watt

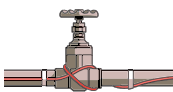

Cut-to-length for small pipes

There's a heating cable just right for the job:

WinterGard heating cable, 3 watts/ft

Catalog #	Description	Voltage	Reel Length (ft)
H311100	TruckPak*	120	100
H311250	Reel	120	250

120 Volt, 6 watt
240 Volt, 6 watt

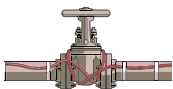

Cut-to-length for large pipes

WinterGard Plus heating cable, 6 watts/ft

Catalog #	Description	Voltage	Reel Length (ft)
H611050	Box	120	50
H611100	TruckPak*	120	100
H611250	Reel	120	250
H621050	Box	240	50
H621100	TruckPak*	240	100
H621250	Reel	240	250

*TruckPak consists of a 100-foot cable reel, two power connections, one splice/tee kit, one roll of application tape, and 10 "Electric Traced" labels.

120 Volt, 6 watt
240 Volt, 6 watt

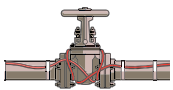

Large pipes

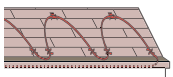

Cut-to-length for wet locations, roof de-icing, and drain lines

WinterGard Wet heating cable, 6 watts/ft

Catalog #	Description	Voltage	Reel Length (ft)
H612050	Box	120	50
H612100	TruckPak*	120	100
H612250	Reel	120	250
H612500	Reel	120	500
H6121000	Reel	120	1000
H622050	Box	240	50
H622100	TruckPak*	240	100
H622250	Reel	240	250
H622500	Reel	240	500
H6221000	Reel	240	1000

120 Volt, 6 watt
240 Volt, 6 watt

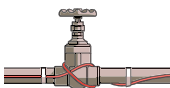

Preassembled
for pipes

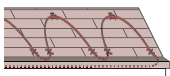

Preassembled
for roofs (120 V only)

FrostGuard heating cable, 6 watts/ft

Catalog #	Voltage	Preassembled Length (ft)
FG1-6P	120	6
FG1-12P	120	12
FG1-18P	120	18
FG1-24P	120	24
FG1-36P	120	36
FG1-50P	120	50
FG1-75P	120	75
FG1-100P	120	100
FG2-6L	240	6
FG2-12L	240	12
FG2-18L	240	18
FG2-24L	240	24

120 Volt, 6 watt
240 Volt, 6 watt

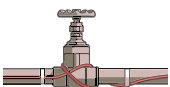

Preassembled
for pipes

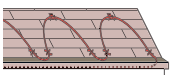

Preassembled
for roofs (120 V only)

Gardian heating cable, 6 watts/ft

Catalog #	Voltage	Preassembled Length (ft)
W51-6P	120	6
W51-12P	120	12
W51-18P	120	18
W51-24P	120	24
W51-50P	120	50
W51-75P	120	75
W51-100P	120	100
W52-6L	240	6
W52-12L	240	12
W52-18L	240	18
W52-24L	240	24

120 Volt
240 Volt

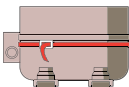

Compressor
crankcase
heating

FreezGard crankcase heater

Catalog #	Voltage	Preassembled Length (ft)
CCH-1C	120	4
CCH-2C	240	4

*TruckPak consists of a 100-foot cable reel, two power connections, one splice/tee kit, one roll of application tape, and 10 "Electric Traced" labels.

Note: Use only in ordinary (nonhazardous) areas. Do not expose to any chemicals. In wet areas, use only WinterGard Wet, FrostGuard, or Gardian.



WARNING: Fire Hazard.

To minimize the danger of fire from sustained electrical arcing if the heating cable is damaged or improperly installed, and to comply with the requirements of Pentair Thermal Building Solutions, agency certifications, and national electrical codes, ground-fault equipment protection must be used on each heating cable branch circuit. Arcing may not be stopped by conventional circuit protection.

Note: This application guide does not take the place of the installation instructions. Carefully follow the installation instructions included in the Raychem accessory kits. Pipes are shown without insulation for illustrative purposes only.

ACCESSORIES

Catalog#	Description	Use
H900	Power Connection Kit (hardwired)	A hardwired power connection and end seal for one heating cable circuit. (Junction box not included.)
H903	Fiberglass Application Tape	To attach heating cable to the pipe. Includes 1 roll (66 ft) of tape and 10 warning labels.
H908	120-V Plug-in Power Connection Kit	A plug-in 120-V, 15-A power connection with built-in ground-fault equipment protection (GFEP) and end seal for one heating cable circuit.
H910	Splice and Tee Kit	Provides material for one splice or one tee and one end seal.
H912	Gel-filled End Seal	Two end seals for sealing the ends of heating cables.
H913	Roof Clips	Clips to attach WinterGard Wet, FrostGuard or Gardian heating cable to the roof surface. Kit contains 10 clips for approximately 7 linear feet of roof edge.
H914	Roof Clips (Bulk Pack)	Clips to attach WinterGard Wet, FrostGuard or Gardian heating cable to the roof surface. Bulk pack kit contains 50 clips for approximately 35 linear feet of roof edge.
H915	Downspout Hanger	Protects one WinterGard Wet, FrostGuard or Gardian heating cable from damage caused by sharp edges in gutter and downspout applications. Also provides strain relief. Kit contains 1 downspout hanger bracket.

Important: Use only these Raychem accessories with Raychem heating cables.

Thermostats, Controllers and Sensors

AMC-F5	Fixed Set Point Thermostat	Ambient or line sensing thermostat with fixed non-adjustable set point of 40°F and 3' bulb and capillary sensor. 22 A at 125/250/480 V
SST-2	Fixed Set Point Thermostat with Built-in GFEP	Ambient or line sensing thermostat with non-adjustable set point of 40°F and 20' thermistor sensor. Includes ground-fault equipment protection (GFEP). 30 A at 100 - 240 V
AMC-1A	Adjustable Set Point Thermostat	Ambient thermostat with adjustable set point of 15°F to 140°F. 22 A at 125/250/480 V
EC-TS	Adjustable Set Point Thermostat	Ambient or line sensing thermostat with adjustable set point of 30°F to 110°F and 25' thermistor sensor. 30 A at 100 - 277 V
PD-Pro	Snow and Ice Controller	Automatic snow controller detects precipitation and low temperature. Interfaces with the CIT-1 and GIT snow and ice sensors (sold separately). 30 A at 100 - 277 V
GF-Pro	Snow and Ice Controller with Built-in GFEP	Automatic snow controller detects precipitation and low temperature. Interfaces with the CIT-1 and GIT-1 snow and ice sensors (sold separately). Includes ground-fault equipment protection (GFEP). 30 A at 100 - 277 V
LCD-8	Snow Switch Controller	2-in-1 control with aerial sensor. Snow switch controller operates heaters at temperatures below 38°F (3.3°C) while moisture in any form is present. 16 A at 100 - 240 V
CIT-1	Snow Sensor	Overhead snow sensor that detects precipitation or blowing snow at ambient temperatures below 38°F (3.3°C). For use in conjunction with the PD-Pro or GF-Pro controllers.
GIT-1	Gutter Sensor	Gutter sensor that detects moisture at ambient temperatures below 38°F (3.3°C). For use in conjunction with the PD-Pro or GF-Pro controllers.

TECHNICAL INFORMATION

TECHNOLOGY

Raychem quality design means superior heating systems

SELF-REGULATION

The self-regulating design of Raychem heating cables eliminates worry about overheating or burn-outs from overlapping. The conductive polymer core automatically adjusts heat output at each point along the pipe.

PARALLEL CIRCUITRY

Unlike conventional heating tapes, Raychem heating cables feature parallel circuitry. This means you can cut it to your desired length while maintaining the power output.

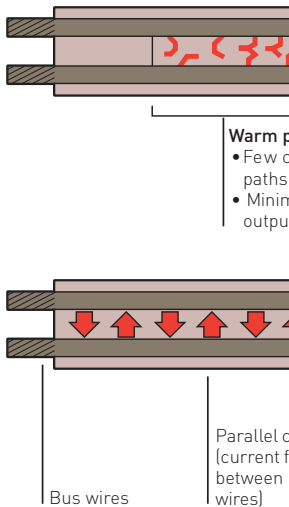

PROVEN ADVANTAGES

Fast, easy to install.

Thanks to their self-regulating, parallel-circuit design, Raychem heating cables require no complex installation procedures. They can be straight-traced, spiraled, or overlapped. On the job, you can cut them to the exact length needed and splice or tee them, adapting each heating cable circuit as the job requires.

Reliable performance.

Raychem heating cables provide years of reliable performance, so you're not bothered by breakdowns or callbacks. They will protect against freezing this winter and for many winters to come.

Designed flexibility.

Hardwire them or plug them in. With two options of power connection kits, the choice is yours. There's even a preassembled heating cable available in convenient lengths to handle small jobs fast.

Convenient and economical.

For larger jobs, you can simply cut the exact amount of heating cable you need right from the reel. No more wasted heating cable or extra trips to the supply house, because you always have the right size with you.

Safe on plastic pipes.

Raychem heating cables can be used on plastic as well as metal pipes. Their self-regulating heating core adjusts automatically, to protect against overheating or developing hot spots when overlapped or covered with insulation.

Energy-efficient.

Raychem heating cables' self-regulating core generates heat when and where it's needed. The core continuously adjusts its heat output to the environment at every point along the heating cable, thus reducing the overall energy cost for the season.

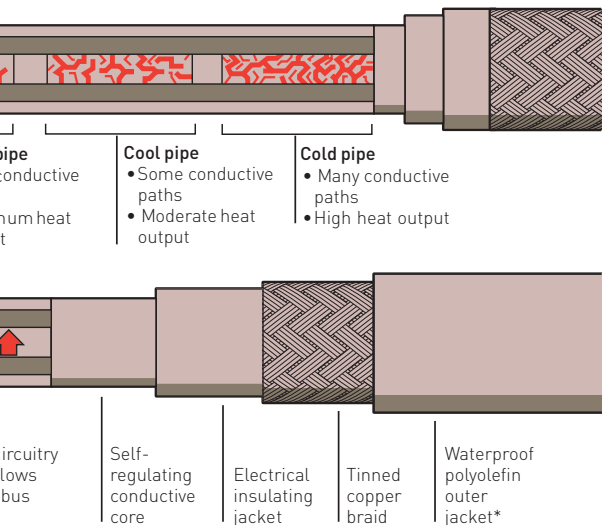

*WinterGard Wet, FrostGuard and Gardian heating cables only

PIPE FREEZE PROTECTION

WINTERGARD 120-V HEATING CABLE **Metal or plastic piping up to 2 inches in diameter in dry locations**

For design flexibility, use WinterGard cut-to-length heating cable. It's the economical solution for both metal and plastic pipes with circuit lengths up to 250 feet. See pages 12–17 for information to help you design your Raychem freeze protection system and pages 34 and 35 for product data.



WinterGard cable is the economical way to winterize cold-water, service, and wastewater lines.*



Use WinterGard cable to freeze-protect water-service systems. It's ideal for both residential and commercial buildings.

*Fully insulate for a complete installation.

WINTERGARD PLUS HEATING CABLE IN DRY LOCATIONS

Large piping up to 6 inches in diameter

Designed for more demanding residential/commercial applications, WinterGard Plus 120-V and 240-V heating cables with a durable metal braid are the right choice for larger plastic and metal pipes with diameters up to 6 inches, circuit lengths up to 200 feet for 120 V and 400 feet for 240 V.



WinterGard Plus cables keep large diameter pipes freeze-free year-round.*

Long piping up to 6 inches in diameter

WinterGard Plus 6 watt, 240-V heating cables are especially designed to save installation time and money in applications requiring long circuit lengths (up to 400 feet).

*Fully insulate for a complete installation.

WINTERGARD WET HEATING CABLE IN WET LOCATIONS

A waterproof outer jacket makes WinterGard Wet 6 watt, 120-V and 240-V heating cables the answer for freeze protection in wet locations such as drain lines. With the waterproof outer jacket, WinterGard Wet heating cables are ideal for providing freeze protection of metal or plastic pipes in wet environments or for de-icing drain lines.



For marine applications or where moisture is a consideration, WinterGard Wet heating cable is the answer.*



The metal braid and additional outer jacket make WinterGard Wet heating cable the best choice for applications such as water supply lines in outdoor locations.

*Fully insulate for a complete installation.

FROSTGUARD AND GARDIAN PREASSEMBLED HEATING CABLE

**Pipe runs up to 100 feet, up to 2 1/2 inches
in diameter**

The perfect solution for small applications and short pipe lengths, FrostGuard or Gardian 120-V cable. FrostGuard is available in lengths of 6, 12, 18, 24, 36, 50, 75, and 100 feet. Gardian is available in lengths of 6, 12, 18, 24, 50, 75, and 100 feet. FrostGuard and Gardian 240-V cables are available in 6, 12, 18, and 24-foot preassembled lengths. Use the tables on pages 18 and 19 to select the right cable for your job.

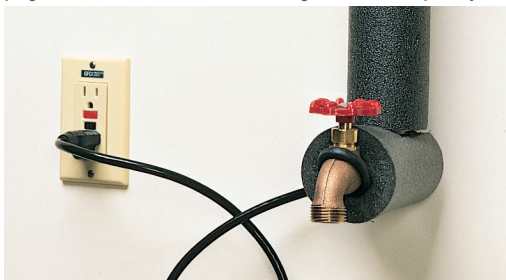

With the 120-V preassembled heating cable, there's no assembly required. Just attach the cable to the pipe, insulate it, and plug it in.



Use FrostGuard or Gardian cable for intake and drain lines, water meters, outside pipes, and taps. It's ideal for pipes in unheated attics, basements, and garages.*

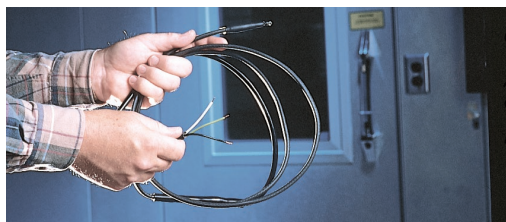

The 240-V preassembled heating cables are easy and convenient for use in refrigeration applications. It prevents freeze-up problems on freezer doors and in drain pans and drain lines.

*Fully insulate for a complete installation.

DESIGNING A CUT-TO-LENGTH PIPE FREEZE PROTECTION SYSTEM

HOW TO DESIGN YOUR WINTERGARD PIPE FREEZE PROTECTION SYSTEM

To design your WinterGard system, follow the step-by-step guidelines that follow, referring to the shaded tables where indicated.

Step 1: Collect the necessary information

Information needed	Example
Type of pipe (metal or plastic)	Metal pipe
Pipe size (0.5 – 6 in)	2.5 in
Lowest expected air temperature (0°F to –40°F)	–20°F
Insulation thickness (0.5 – 2 in)	0.5 in
Voltage (120 V or 208 – 240 V)	120 V
Location (wet or dry)	Wet

Ensure your application complies with the product data (Table 13) on pages 34 and 35.

Table 1:
Heating Cable
Selection Table
(Metal Pipes)

For metal pipes*			
Lowest air temperature	Insulation thickness	Pipe size (in inches)	
		0.50	0.75
0°F	0.5 in		
	1.0 in		
	1.5 in		
–20°F	0.5 in		
	1.0 in		
	1.5 in		
	2.0 in		
–40°F	0.5 in		
	1.0 in		
	1.5 in		
	2.0 in		

Table 2:
Heating Cable
Selection Table
(Plastic Pipes)

For plastic pipes*			
Lowest air temperature	Insulation thickness	Pipe size (in inches)	
		0.50	0.75
0°F	0.5 in		
	1.0 in		
	1.5 in		
–20°F	0.5 in		
	1.0 in		
	1.5 in		
	2.0 in		
–40°F	0.5 in	1.1	1.1
	1.0 in		
	1.5 in		
	2.0 in		

* Information is based on pipes with fiberglass insulation or equivalent and minimum maintain temperature of 40°F.

Step 2: Determine heating cable type

	120 V	208 V – 240 V
Dry	H311, H611, H612	H621, H622
Wet	H612	H622

Step 3: Determine the heating cable wattage and spiraling ratio

Use Table 1 to select heating cables for insulated metal pipes. Use Table 2 to select heating cables for insulated plastic pipes. Read across the table to find your pipe diameter, then drop down to the line corresponding to the lowest air temperature for that application and the correct insulation thickness. The cell at that intersection has a particular shading and may have a number. The shading indicates which heating cable to use (key to the shading appears table below). A number represents the spiraling ratio (feet of heating cable per foot of pipe).

If no number appears in the cell, straight trace the pipe. If a number does appear in the cell, spiral trace the pipe.

If your spiraling ratio is 2.0, multiple-trace the pipe using two straight traces at the 4 o'clock and 8 o'clock positions.

If your spiraling ratio is 3.0, multiple-trace using three straight traces at the 11 o'clock or 1 o'clock position **and** at the 4 o'clock and 8 o'clock positions.

1.00	1.25	1.50	2.00	2.50	3.00	4.00	6.00
						1.3	1.8
			1.1	1.3	1.5	1.8	3.0
						1.1	1.5
							1.1
	1.1	1.2	1.4	1.7	2.0	3.0	
					1.1	1.4	1.9
							1.4
							1.1

1.00	1.25	1.50	2.00	2.50	3.00	4.00	6.00
			1.2	1.4	1.7	2.0	3.0
						1.2	1.6
							1.2
1.1	1.3	1.5	1.8	2.0	3.0		
			1.1	1.2	1.4	1.8	3.0
					1.1	1.3	1.7
							1.4
1.5	1.8	2.0	3.0	3.0			
	1.1	1.2	1.4	1.6	1.9	3.0	
			1.1	1.2	1.4	1.7	3.0
					1.1	1.3	1.8

Key to Tables 1 and 2: H311 H611, H621, H612, H622 Increase insulation thickness

Step 4: Formula: Calculate the total heating cable length

To calculate the total amount of heating cable needed, you will need to add additional lengths of cable to account for various valves and fittings to the amount of cable already calculated in Step 3. Follow the formula below to calculate the total amount of heating cable needed.

Length = A + B + C + D + E + F	
A	Pipe length x spiral ratio*
B	4 ft x # gate/globe valves x length adjustment factor** x spiral ratio*
C	2 ft x # ball/butterfly valves/flanges/supports x length adjustment factor** x spiral ratio*
D	1 ft for each power connection
E	2 ft for each splice connection
F	3 ft for each tee connection
=	Total heating cable length (ft)

*From Step 3

**See Table 3 below

Table 3: Heating cable length adjustment

Pipe Size	Factor
1/2 in	0.04
1 in	0.08
2 in	0.17
3 in	0.25
4 in	0.33
5 in	0.42
6 in	0.50

Example: (taken from page 12)

Pipe length	50 ft
Spiral ratio	1.3 (from Table 1, pages 12 and 13)
Globe valves	3 (each 0.5 ft long)
Pipe supports	10 supports for 1-inch pipe
Power connections	1
Splice connections	1

WinterGard heating cable required

A	Pipe length x spiral ratio	= 50 ft x 1.3	= 65.0 ft
B	3 globe valves (0.5 ft. each)	= 4 ft x 3 x 0.5 x 1.3	= 7.8 ft
C	10 pipe supports	= 2 ft x 10 x 0.085 x 1.3	= 2.2 ft
D	1 power connection	= 1 ft x 1	= 1.0 ft
E	1 splice connection	= 2 ft x 1	= 2.0 ft
F	0 tee connection	= 0	= 0
Total heating cable length required			= 78.0 ft

Step 5: Determine the number of heating cable circuits

For the maximum heating cable circuit length permitted for a given circuit breaker rating, refer to Table 4 below. Find the appropriate row according to the selected heating cable type and circuit breaker rating. Move across the row to the appropriate minimum start-up temperature. (Use 40°F start-up temperature unless 0°F is required when start-up is below the freezing point.)

If the total heating cable length is greater than the maximum circuit length, use shorter lengths and more circuits. Make sure that each circuit is less than the maximum circuit length shown in Table 4. Select the smallest circuit breaker appropriate for your circuit length.

Example:

You have: WinterGard Wet heating cable: 120 V Start-up temperature: 40°F Circuit breaker rating: 15 amps Total heating cable length: 78.0 ft
You find: 150 ft maximum circuit length
You need: 1 heating cable circuit

Table 4: Maximum heater circuit length on pipe*

Heater type	Circuit breaker rating (A)	Maximum heater length (ft) per circuit at start-up temperature*	
		0°F	40°F
WinterGard 120 V H311	15	150	250
	20	200	250
	30	250	250
WinterGard Plus 120 V H611	15	125	150
	20	140	195
	30	200	200
WinterGard Plus 240 V H621	15	200	255
	20	250	340
	30	375	400
WinterGard Wet 120 V H612	15	125	150
	20	140	195
	30	200	200
WinterGard Wet 240 V H622	15	200	255
	20	250	340
	30	375	400

* Maximum circuit lengths are based on start-up load. Steady state amperes per foot is dependent upon heating cable temperature.

Step 6: Select the accessories

The diagram below shows typical heating systems assembled with the proper Raychem accessories. Either the H900 or H908 power connection kit must be used. See Table 5 to select additional accessories that may be needed for your installation.

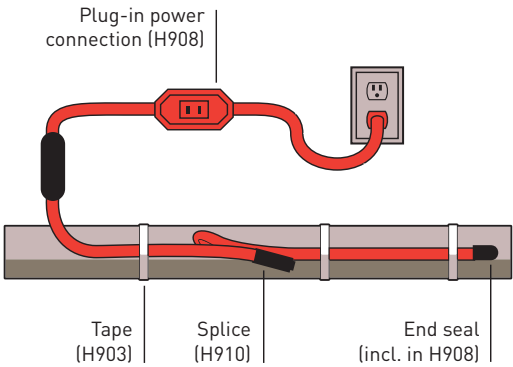
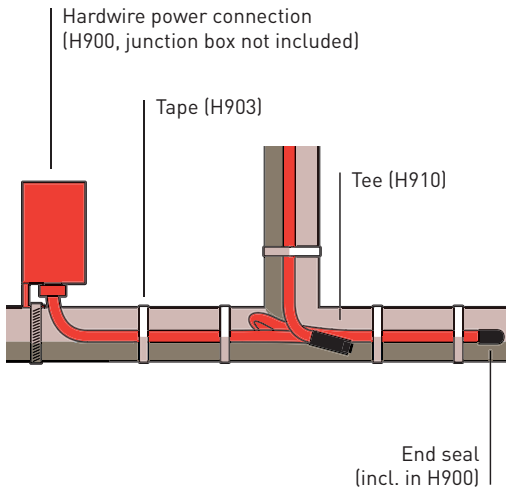

Table 5: Accessories for Raychem heating cable for pipe applications

Catalog number	Description	Use
H900	Power Connection Kit (hardwired)	A hardwired power connection and end seal for one heating cable circuit. (Does not include junction box.)
H903	Fiberglass Application Tape	To attach heating cable to the pipe. Includes 1 roll (66 ft) of tape and 10 warning labels.
H908	120-V Plug-in Power Connection Kit	A plug-in 120-V, 15-A power connection with built-in ground-fault equipment protection (GFEP) and end seal for one heating cable circuit.
H910	Splice and Tee Kit	Provides material for one splice or one tee and one end seal.
H912	Gel-filled End Seal	Two end seals for sealing the ends of heating cables.

Thermostats

AMC-F5	Fixed Set Point Thermostat	Ambient or line sensing thermostat with fixed non-adjustable set point of 40°F and 3' bulb and capillary sensor. 22 A at 125/250/480 V
SST-2	Fixed Set Point Thermostat with Built-in GFEP	Ambient or line sensing thermostat with non-adjustable set point of 40°F and 20' thermistor sensor. Includes ground-fault equipment protection (GFEP). 30 A at 100 - 240 V
AMC-1A	Adjustable Set Point Thermostat	Ambient thermostat with adjustable set point of 15°F to 140°F. 22 A at 125/250/480 V
EC-TS	Adjustable Set Point Thermostat	Ambient or line sensing thermostat with adjustable set point of 30°F to 110°F and 25' thermistor sensor. 30 A at 100 - 277 V

Step 7: Install the system.

Refer to installation instructions in the H900 or H908 kit.



WARNING: Fire Hazard.

To minimize the danger of fire from sustained electrical arcing if the heating cable is damaged or improperly installed, and to comply with the requirements of Pentair Thermal Building Solutions, agency certifications, and national electrical codes, ground-fault equipment protection must be used on each heating cable branch circuit. Arcing may not be stopped by conventional circuit protection.

PREASSEMBLED HEATING CABLE DESIGN ON PIPES

HOW TO DESIGN YOUR FROSTGUARD OR GARDIAN PIPE FREEZE PROTECTION SYSTEM

Use Tables 6 and 7 below to select the correct heating cable. Add 1 foot to the pipe length for each valve or spigot in the pipe system. Table assumes lowest outside temperature is 0°F, with a minimum of 1/2 inch fiberglass insulation or equivalent. For protection to -20°F, use 1 inch fiberglass insulation or equivalent.

Table 6: FrostGuard (FG1) or Gardian (W51) 120 V Product Selection

120 V for Metal Pipes

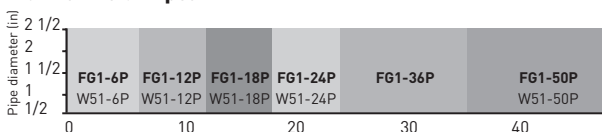

120 V for Plastic Pipes

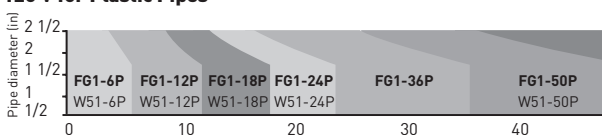
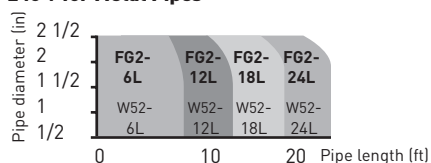
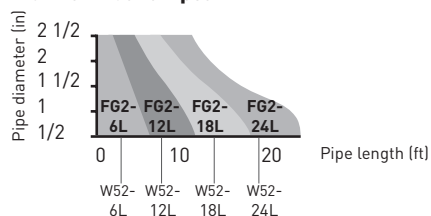

Table 7: FrostGuard (FG2) or Gardian (W52) 240 V Product Selection

240 V for Metal Pipes



240 V for Plastic Pipes



Raychem 120-V FrostGuard cables are available in 6, 12, 18, 24, 36, 50, 75, and 100 foot lengths, and comes assembled with a 6-ft power cord and lighted plug.

Raychem 120-V Gardian cables are available in 6, 12, 18, 24, 50, 75, and 100 foot lengths, and comes assembled with a 2.5-ft power cord and plug.

Raychem 240-V FrostGuard and Gardian hardwired versions are available in 6, 12, 18, and 24 foot lengths. FrostGuard comes assembled with a 6-ft power cord, while Gardian comes assembled with a 2.5-ft power cord for terminating in a junction box.

Table 8: Accessories for FrostGuard

Catalog number	Description	Use
H903	Fiberglass Application Tape	To attach heating cable to the pipe. Includes 1 roll (66 ft) of tape and 10 warning labels.

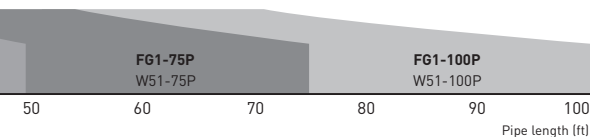
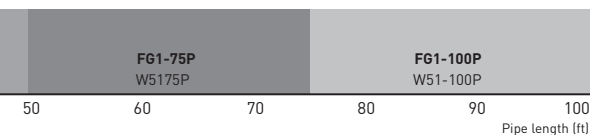

WARNING: Fire Hazard.

To minimize the danger of fire from sustained electrical arcing if the heating cable is damaged or improperly installed, and to comply with the requirements of Pentair Thermal Building Solutions, agency certifications, and national electrical codes, ground-fault equipment protection must be used on each heating cable branch circuit. Arcing may not be stopped by conventional circuit protection.

ROOF AND GUTTER DE-ICING

DE-ICE ROOFS AND GUTTERS WITH WINTERGARD WET, FROSTGUARD OR GARDIAN HEATING CABLES

Winter storms cause ice and snow build-ups on roofs and in gutters. Downspouts clog, intensifying the problem. Serious structural damage may result when melting snow penetrates under the roof surface and refreezes. Gutters and downspouts crack, sag, and break from the ice pressure. Put an end to ice buildups and costly repairs.

Note: For roof and gutter de-icing application, this document does not include all the information required to properly design a complete installation. You must refer to the WinterGard Wet Design, Installation, and Maintenance Guide (H56804).



Reliably de-ice roofs of all kinds, including metal, shingle, and tile.



Keep roof drains in residential applications running free.

Note: For commercial building with large flat roofs, contact Pentair Thermal Building Solutions, (800) 545-6258.

The roof and gutter de-icing systems covered in this design guide are for normal winter conditions. For extreme winter conditions with snow fall accumulation of 9 inches or more and ambient temperatures below 0°F contact Pentair Thermal Building Solutions, (800) 545-6258.

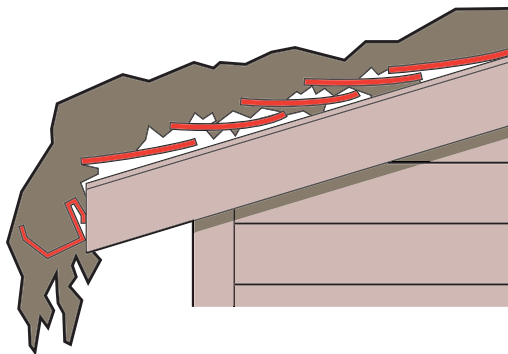

Easy to install for any size job

For larger jobs, WinterGard Wet heating cable can be cut to the exact length you need. With its preassembled design, FrostGuard or Gardian heating cables are ideal for small jobs such as porches and overhangs.

Reliable

With WinterGard Wet, FrostGuard and Gardian heating cables' self-regulating design there are no burnouts caused by overlapping. And the durable metallic braid and waterproof outer jacket provide additional protection against damage.

Energy-saving

WinterGard Wet, FrostGuard and Gardian heating cables automatically save on energy costs by increasing heat output when snow and ice are present and decreasing output when ice melts away. The heating cables supply heat when and where it's needed.

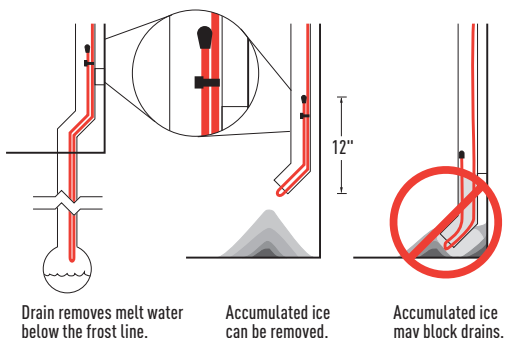

Internally trace downspout and downspout drain lines.

Note: WinterGard Wet cannot be installed inside any storm drains, or in downspout drains where oil or grease may be present.

DESIGNING A ROOF AND GUTTER DE-ICING SYSTEM WITH WINTERGARD WET HEATING CABLES

HOW TO DESIGN YOUR ROOF AND GUTTER DE-ICING SYSTEM

To set up your de-icing system to prevent ice buildup on roof edges or in gutters and downspouts, follow these four steps:

Step 1: Calculate heating cable length.

Find the number of feet of heating cable needed per foot of roof edge in Table 9 on next page. Then, calculate the amount of total heating cable length you need using the following formula:

Formula:

Length = A + B + C + D + E + F + G	
A	Roof edge length (ft) x feet of heating cable per foot of roof edge (from Table 9)
B	Roof edge length (ft) x 0.5*
C	Total gutter length (ft)
D	Total downspout length (ft) + 1 (ft)
E	3 ft for each power connection
F	2 ft for each splice connection
G	3 ft for each tee connection
= Total heating cable length (ft)	

*Roof extension: This length allows the heating cable to extend into the gutter to provide a continuous drain path, or where no gutters are present, extends beyond the roof edge to form a drip loop.

Example:

WinterGard Wet heating cable required:		
Overhang:	12 in	
A Roof edge:	50 ft x 2.8 ft (from Table 9)	= 140 ft
B Roof extension:	50 ft x 0.5	= 25 ft
C Roof gutter:	50 ft	= 50 ft
D Downspout:	15 ft + 1 ft	= 16 ft
E Power connection:	3 ft x 2 ea	= 6 ft
Total WinterGard Wet cable required:		= 237 ft

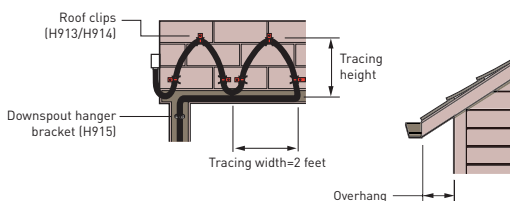

Table 9: WinterGard Wet cable length for roof de-icing

Length of heating cable per foot of roof edge (feet)		Standing seam metal roof:	
Eave overhang	Shingle roof	18 in seam	24 in seam
0	2.0 ft	2.5 ft	2.0 ft
12 in	2.8 ft	2.8 ft	2.4 ft
24 in	3.8 ft	3.6 ft	2.9 ft
36 in	4.8 ft	4.3 ft	3.6 ft

Note: Pentair Thermal Building Solutions recommends gutters and downspouts to provide a continuous path for melted water.

- If downspout is in the middle of the run, loop the heating cable down and back up. Double the length of the downspout for determining the length of heating cable to install.
- For valleys, run the heating cable two thirds of the way up and down the valley.
- For gutters 5–6 inches wide, use 2 runs of heating cable.
- For gutters wider than 6 inches, contact Pentair Thermal Building Solutions, (800) 545-6258.

Step 2: Determine maximum heating cable circuit length.

Refer to Table 10 below for the maximum heating cable circuit length permitted for a given circuit breaker rating. Choose circuit breaker rating and read across to the right column. Select the smallest circuit breaker appropriate for your circuit length.

If your total heating cable length is greater than the maximum circuit length shown in Table 10, split the heating cable into more circuits.

Example:

You have:	237 ft total heating cable length 120 V @ 32°F start-up
	Circuit breaker rating: 30 amps
You find:	200 ft maximum circuit length
	Using WinterGard Wet 120-V heating cable, you need two heating circuits:
	Circuit 1: 168 ft heating cable for roof edge, roof extension and power connection
	30 amp breaker
	Circuit 2: 69 ft heating cable for gutter, downspout, and power connection
	15 amp breaker

Alternatively, using WinterGard Wet 240-V cable with a 240-V power supply @ 32°F start-up; this installation would require only one 237 ft heating circuit with a 15 amp breaker.

Table 10: Maximum heating cable circuit length for roof and gutter de-icing, downspouts and refrigeration condensate drains*

Heating cable type	Circuit breaker rating (A)	Maximum heater length (ft) per circuit for min. start-up temperature	
		0°F	32°F
WinterGard Wet 120 V H612	15	100	125
	20	125	165
	30	150	200
WinterGard Wet 240 V H622	15	200	250
	20	250	320
	30	305	400

*Maximum circuit lengths are based on start-up load. Steady state amperes per foot is dependent upon heating cable temperature.

The National Electrical Code requires ground-fault protection of equipment for all heat-tracing applications, including snow-melting and de-icing applications. The H908 kit is equipped with built-in ground-fault protection of equipment.

For additional information, refer to the WinterGard Wet Design Installation and Maintenance Guide (H56804).



WARNING: Fire Hazard.

To minimize the danger of fire from sustained electrical arcing if the heating cable is damaged or improperly installed, and to comply with the requirements of Pentair Thermal Building Solutions, agency certifications, and national electrical codes, ground-fault equipment protection must be used on each heating cable branch circuit. Arcing may not be stopped by conventional circuit protection.

Step 3: Select WinterGard Wet accessories:

Catalog

number	Description	Use
H900	Power Connection Kit (hardwired)	A hardwired power connection and end seal for one heating cable circuit. (Does not include junction box.)
H908	120-V Plug-in Power Connection Kit	A plug-in 120-V, 15-A power connection with built-in ground-fault equipment protection (GFEP) and end seal for one heating cable circuit.
H910	Splice and Tee Kit	Provides material for one splice or one tee and one end seal.
H912	Gel-filled End Seal	Two end seals for sealing the ends of heating cables.
H913	Roof Clips	Clips to attach WinterGard Wet or FrostGuard heating cable to the roof surface. Kit contains 10 clips for approximately 7 linear feet of roof edge.
H914	Roof Clips (Bulk Pack)	Clips to attach WinterGard Wet or FrostGuard heating cable to the roof surface. Bulk pack kit contains 50 clips for approximately 35 linear feet of roof edge.
H915	Downspout Hanger	Protects one WinterGard Wet or FrostGuard heating cable from damage caused by sharp edges in gutter and downspout applications. Also provides strain relief. Kit contains one downspout hanger bracket.

Controllers and Sensors

PD-Pro	Snow and Ice Controller	Automatic snow controller detects precipitation and low temperature. Interfaces with the CIT-1 and GIT-1 snow and ice sensors (sold separately). 30 A at 100 - 277 V
GF-Pro	Snow and Ice Controller with Built-in GFEP	Automatic snow controller detects precipitation and low temperature. Interfaces with the CIT-1 and GIT-1 snow and ice sensors (sold separately). Includes ground-fault equipment protection (GFEP). 30 A at 100 - 277 V
LCD-8	Snow Switch Controller	2-in-1 control with aerial sensor. Snow switch controller operates heaters at temperatures below 38°F (3.3°C) while moisture in any form is present. 16 A at 100 - 240 V
CIT-1	Snow Sensor	Overhead snow sensor that detects precipitation or blowing snow at ambient temperatures below 38°F (3.3°C). For use in conjunction with the PD-Pro or GF-Pro controllers.
GIT-1	Gutter Sensor	Gutter sensor that detects moisture at ambient temperatures below 38°F (3.3°C). For use in conjunction with the PD-Pro or GF-Pro controllers

Step 4: Install the system

Follow the installation steps in the H900 or H908 Power Connection Kit. Do not install the H908 connection kits in the gutter or where it can be immersed.

DESIGNING A ROOF AND GUTTER DE-ICING SYSTEM WITH 120-V FROSTGUARD OR GARDIAN PREASSEMBLED HEATING CABLES

HOW TO DESIGN YOUR ROOF AND GUTTER DE-ICING SYSTEM FOR SMALLER JOBS

To set up your de-icing system to prevent ice buildup on roof edges on smaller jobs like porches and overhangs or in gutters and downspouts, follow these three steps:

Step 1: Calculate heating cable length.

Find the number of feet of heating cable needed per foot of roof edge in Table 11 on page 27. Then, calculate the amount of total heating cable length you need using the following formula:

Formula:

Length = A + B + C + D	
A	Roof edge length (ft) x Feet of heating cable per foot of roof edge
B	Roof edge (ft) x 0.5*
C	Total gutter length (ft)
D	Total downspout length (ft) +1 (ft)
= Total heating cable length (ft)	

*Roof extension: This length allows the heating cable to extend into the gutter to provide a continuous drain path, or where no gutters are present, extends beyond the roof edge to form a drip loop.

Example:

FrostGuard or Gardian heating cable required (shingled roof):

Overhang: 12 in

Roof edge: 15 ft

Roof gutter: 15 ft

Downspout: 15 ft (at end of circuit)

FrostGuard or Gardian heating cable required:

A Roof edge: 15 ft x 2.8 (from Table 11) = 42 ft

B Roof extension: 15 ft x 0.5 = 7.5 ft

C Roof gutter: 15 ft = 15.0 ft

D Downspout: 15 ft + 1 ft = 15.0 ft

Total heating required: = **80.5 ft**

FrostGuard required: FG1-100P

Gardian required: W51-100P

Note: For lengths greater than 100 feet or 240 V applications, use Winter-Gard Wet heating cables.

Table 11: FrostGuard or Gardian cable length for roof de-icing

Length of heating cable per foot of roof edge (feet)

Eave overhang	Shingle roof	Standing seam metal roof:	
		18 in seam	24 in seam
0	2.0 ft	2.5 ft	2.0 ft
12 in	2.8 ft	2.8 ft	2.4 ft
24 in	3.8 ft	3.6 ft	2.9 ft
36 in	4.8 ft	4.3 ft	3.6 ft

Note: Pentair Thermal Building Solutions recommends gutters and downspouts to provide a continuous path for melted water.

- If downspout is in the middle of the run, loop the FrostGuard or Gardian down and back up. Double the length of the downspout for determining the length of FrostGuard or Gardian to install.
- For valleys, run the heating cable two thirds of the way up and down the valley.
- For gutters 5-6 inches wide use 2 runs of heating cable.
- For gutters wider than 6 inches contact Pentair Thermal Management, (800) 545-6258.



WARNING: Fire Hazard.

To minimize the danger of fire from sustained electrical arcing if the heating cable is damaged or improperly installed, and to comply with the requirements of Pentair Thermal Building Solutions, agency certifications, and national electrical codes, ground-fault equipment protection must be used on each heating cable branch circuit. Arcing may not be stopped by conventional circuit protection.

Step 2: Select FrostGuard accessories:

Catalog number	Description	Use
H913	Roof Clips	Clips to attach FrostGuard or Gardian heating cable to the roof surface. Kit contains 10 clips for approximately 7 linear feet of roof edge.
H914	Roof Clips (Bulk Pack)	Clips to attach FrostGuard or Gardian heating cable to the roof surface. Bulk pack kit contains 50 clips for approximately 35 linear feet of roof edge.
H915	Downspout Hanger Bracket	Protects one FrostGuard or Gardian heating cable from damage caused by sharp edges in gutter and downspout applications. Also provides strain relief. Kit contains one downspout hanger bracket.

Step 3: Follow the installation steps in the FrostGuard or Gardian installation instructions.

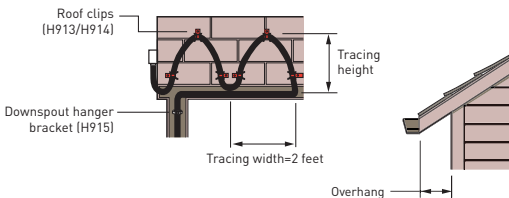

REFRIGERATION APPLICATIONS

Ice buildup can impair performance as well as damage critical refrigeration systems. Freeze-ups, backups, and compressor burnouts are a real threat. Raychem heating cables and FreezGard crankcase heaters provide an easy, reliable way to control downtime and expensive repairs.

Convenient

Parallel-circuit design lets you cut Raychem heating cables to the precise length you need. It's easy to wrap pipes or trace problem areas without wasting product or installation time. And because self-regulating design permits overlapping, Raychem heating cables and FreezGard crankcase heaters are easy to use in confined spaces.

Durable

A metal braid on all Raychem cables provides electrical ground path and adds mechanical strength. The waterproof outer jacket on WinterGard Wet heating cables makes them ideal for drains and other areas subject to wet conditions.

Efficient

As equipment goes through its on/off cycle, Raychem heating cables and FreezGard crankcase heaters can automatically increase heat output when temperatures drop, then decrease output as temperatures rise—maintaining the equipment temperatures while minimizing energy costs.

WINTERGARD PLUS HEATING CABLE

Plastic and other pipes in dry locations

For a variety of pipe and surface-tracing installations, WinterGard Plus heating cable gives you 6-watt/ft output in 120-V or 240-V systems to match your available supply voltage.

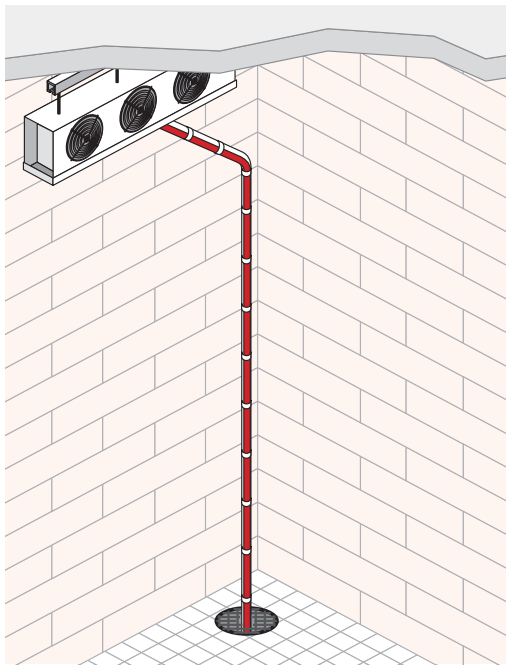

Its adaptability to a wide range of pipe diameters and line runs makes WinterGard Plus heating cable ideal for protecting condensate drainlines from freezing in refrigeration applications.*

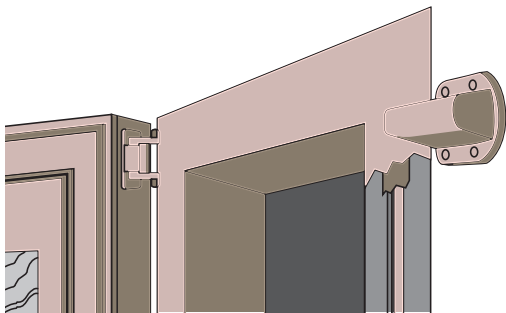

Tracing door frames helps prevent surfaces from freezing shut. Heating cable is placed in routed section of door or door frame and must be protected from mechanical damage.

*Fully insulate for a complete installation.

WINTERGARD WET HEATING CABLE

Wet locations

For applications where water is present, an additional outer jacket makes WinterGard Wet heating cable both waterproof and abrasion-resistant. Choose 120-V or 240-V versions, depending on your supply voltage.



Waterproof jacket lets WinterGard Wet heating cable trace drain pans so water keeps flowing.

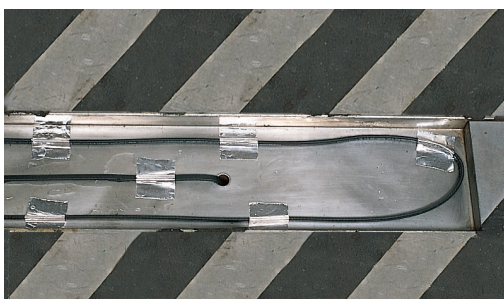

Other wet locations, such as drain lines in freezer cases, avoid backup problems when internally traced with WinterGard Wet heating cable.

Note: See pages 12 and 13 for information to help you design your Raychem freeze protection system. See Table 5 on page 17 to select accessories.

FREEZGARD SELF-REGULATING CRANK-CASE HEATERS FOR REFRIGERATION COMPRESSORS

Prolong life and increase compressor efficiency

When compressors operate in cold areas, refrigerant can migrate into the crankcase oil whenever the compressor is not running.

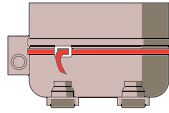

On start-up, this can cause excessive motor wear and a loss of refrigeration efficiency.

FreezGard self-regulating crankcase heaters provide reliable peak heating during these critical cold periods and, unlike conventional constant-wattage heaters, reduce their heating once the compressor starts up or when air temperatures rise, saving energy. Also, self-regulating heaters can be safely overlapped and closely spaced without burning out, so one size fits all hermetic and scroll compressors up to 5 HP that are 40 inches or less in circumference.

Models for 120 V and 208–277 V are available, and each comes with a flexible lockstrap and prestripped 28 inch cold leads for easy connection and hard-wiring. Use only with refrigeration compressors in nonhazardous areas.

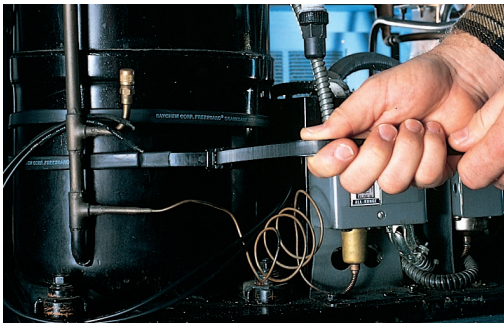

The FreezGard crankcase heater's self-regulating design automatically varies output to maintain adequate oil temperature, while minimizing energy use.

Table 12: FreezGard technical information

Service voltage	CCH-1C: 120; CCH-2C: 208-277
Power output at 50°F	32 watts minimum
Power output at 0°F	60 watts minimum
Cold lead wire gauge (AWG)	18
Cable width (inches)	0.615
Cable thickness (inches)	0.245
Cable length (inches)	48
Cold lead length (inches)	28
Maximum exposure temperature (intermittent)	185°F
Insulation jacket type	Modified polyolefin
Compressor girth (wraparound) dimension	40 inches or less circumference

GENERAL INFORMATION

Table 13: Product Data

	WinterGard	WinterGard Plus	
	H311100 H311250	H611050 H611100 H611250	H6211050 H6211100 H6211250
Nominal service voltage	120	120	208
Minimum power output at 40°F on pipes (W/ft)	3	6	6
Nominal power output in drains, ice and snow	n/a	n/a	n/a
Maximum circuit length (ft) for pipes	250	200	400
Maximum circuit length (ft) for roof and gutter de-icing	n/a	n/a	n/a
Maximum circuit breaker size (A)	30	30	30
Weight per 100 ft (lb)	6	6	6
Maximum exposure temp. (°F)	150	150	150
Environment*	Dry area pipes	Dry area pipes	
Approvals			
UL System Listed	(2)	(2)	(2)
CSA Certified	(4)	(4)	(4)

* Use only in ordinary (nonhazardous) areas. Do not expose to any chemicals. In wet areas:
 (1) c-CSA-us Certified to US and Canadian Standards.
 (2) 718K Pipe Heating Cable.
 (3) 877Z Roof De-Icing and Snow Melting Equipment.
 (4) CSA.

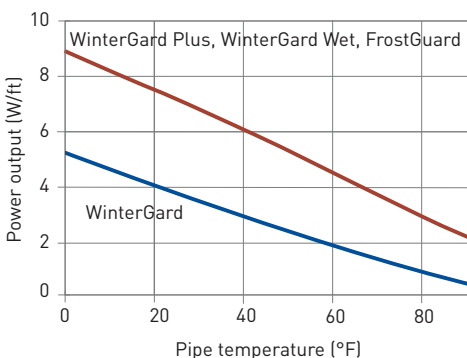

Power Output vs Pipe Temperature on Metal Pipes

	WinterGard Wet		FrostGuard (FG1 & FG2) or Gardian (W51 & W52)	
			FG1-6P	
			FG1-12P	
			FG1-18P	
			FG1-24P	
			FG1-36P	
			FG1-50P	
			FG1-75P	FG2-6L
			FG1-100P	FG2-12L
			W51-6P	FG2-18L
	H612050	H622050	W51-12P	FG2-24L
	H612100	H622100	W51-24P	W52-6L
050	H612250	H622250	W51-50P	W52-12L
100	H612500	H622500	W51-75P	W52-18L
250	H6121000	H6221000	W51-100P	W52-24L
- 240	120	208 – 240	120	208 – 240
	6	6	6	6
	8	8	8	n/a
	200	400	n/a	n/a
	200	400	n/a	n/a
	30	30	30	30
	9	9	n/a	n/a
	150	150	150	150
	Dry and wet area pipes, drains and roof		roof & gutter de-icing Pipes only	
	[2, 3]	[2, 3]		
	[4]	[4]	[1]	[1]

as, use only WinterGard Wet, FrostGuard or Gardian.



WWW.PENTAIRTHERMAL.COM

NORTH AMERICA

Tel: +1.800.545.6258

Fax: +1.800.527.5703

Tel: +1.650.216.1526

Fax: +1.650.474.7711

thermal.info@pentair.com

Pentair, FreezGuard, FrostGuard, Gardian, TruckPak, WinterGard, WinterGard Plus, and WinterGard Wet are owned by Pentair or its global affiliates. All other trademarks are the property of their respective owners. Pentair reserves the right to change specifications without prior notice.

© 1997-2016 Pentair.

 @pentairTBS

THERMAL BUILDING SOLUTIONS

Raychem-DG-H53585-ResidentialLightComm-EN 16/10