



Submittal Data Information

0026^e™

ECM High-Efficiency Circulator

101-194

Effective: January 18, 2022

Supersedes: August 16, 2021

Job: _____ Engineer: _____ Contractor: _____ Rep: _____

ITEM NO.	MODEL NO.	

Specifications

- Maximum Shut-off Head: 26 feet
- Maximum Flow: 44 gpm
- Maximum Operating Pressure: 150 psi (10.3 bar)
- Maximum Water Temp: 230°F (110°C)
- Minimum Water Temp: 14°F (-10°C)
- Electrical specifications:
 - Voltage: 115V/208/230, 50/60 Hz Single phase
 - Operating Power Range: 10 - 120W
 - Max. AMP Rating: 1.0 (115V) - 0.50 (230V)
- Equipped with a Cast Iron or Stainless Steel casing
- Suitable for chilled water systems
- Stainless Steel model suitable for open loop potable water systems
- Taco circulators are for indoor use only
- Acceptable for use with water or maximum of 50% water/glycol solution
- 6.5" Flange to Flange dimension retrofits most circulators in its class

Materials of Construction:

Casing:Cast Iron or Stainless Steel

Stator Housing:Composite

Control Base:Composite

Control Cover:Composite

Cartridge:Composite

Impeller:Composite

Shaft:Ceramic

Rotor:Neodymium

Bearings:Ceramic

Thrust Bearing:Carbon

O-Ring & Gaskets:EPDM

Applications

Cast Iron Model: Closed loop, pressurized heating and chilled water HVAC systems.

Stainless Steel Model: Open loop, potable water systems.

The 0026e is a high-performance, variable speed, wet-rotor circulator with high-efficiency ECM permanent magnet technology. With 5 easy settings, its variable speed performance curves are equivalent to the Taco 0010, 0011, 0012, 0012 3-Speed & 0014. Ideal for large residential and light commercial hydronic heating, chilled water cooling and domestic hot water systems. The 0026e reduces power consumption by up to 85% compared to equivalent AC permanent split capacitor circulators.

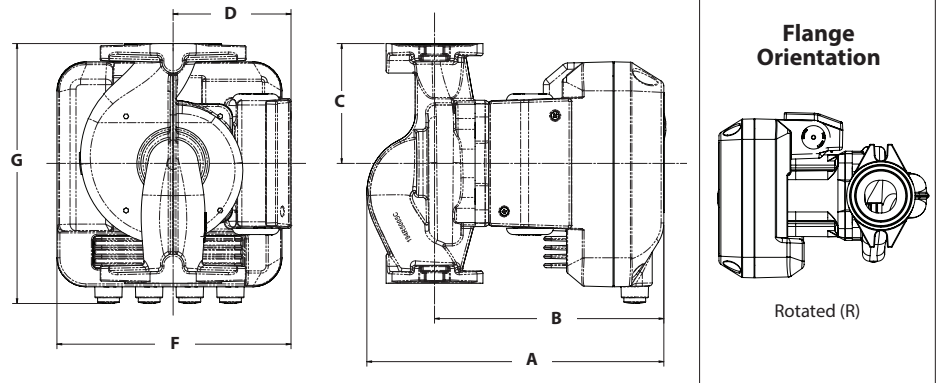

Pump Dimensions & Weights

Model Number	Casing	Flange Type	Inches [mm]						Wt.lbs. [kg]
			A	B	C	D	F	G	
0026e-F2	Cast Iron	R	8.05" [205]	6.22" [158]	3.25" [83]	3.20" [81]	6.22" [158]	7.05" [179]	10.5 [4.8]
0026e-SF2	Stainless Steel								

Electrical Data

Model	Volts	Hz	Ph	Max Amps	Watts	RPM
All Models	115/208/230	50/60	1	1	120	830 - 3800
Motor Type	ECM, Permanent Magnet, Electronically Protected					

Rotatable Control Cover to allow mounting in any orientation

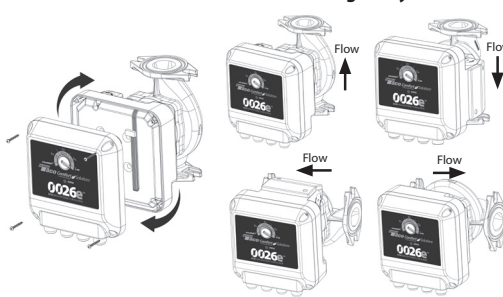

Model #: 0026e

WAIP: 0.194

CIRCULATOR PUMP CEI: 0.45 (ER 154)

ENERGY RATING



Note: The ER value is dependent on the selected control. Multiple options may be available on this pump, as follows:

- Full Speed
- Pressure (Rated)
- External Input Signal and Other Controls

Power savings (watts) over a baseline case can be estimated by multiplying the ER by WAIP and multiplying by 7.46. Multiplying power savings by operating hours and cost of energy will yield estimated cost savings.

4ZB91K

er.pumps.org

Apr 2021



Certified to NSF/ANSI 61 & 372

Stainless Steel Model

activeADAPT® Mode:

activeADAPT is an operating mode designed for constant circulation systems. On this setting, the circulator will sense changes in system flow and head conditions and adjust the operating curve automatically.

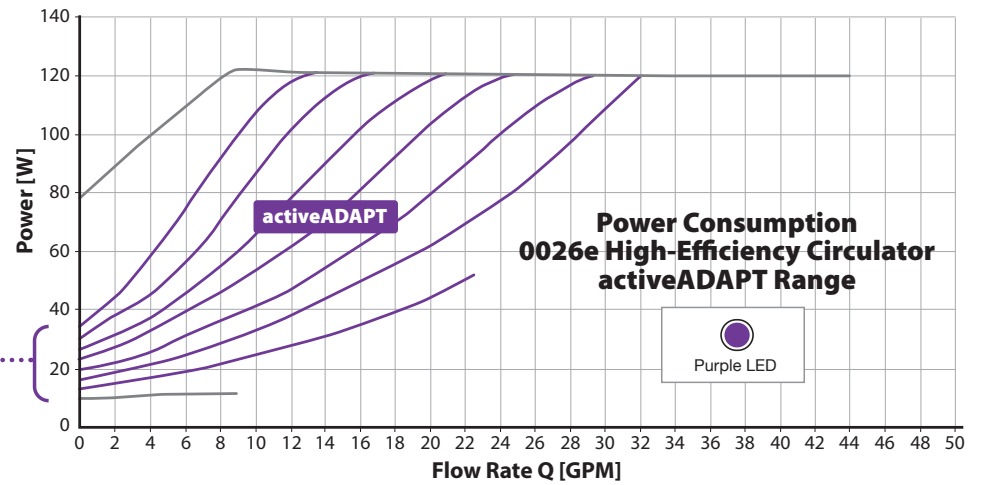
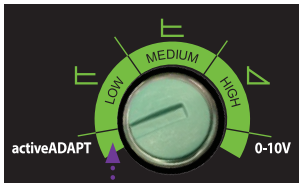
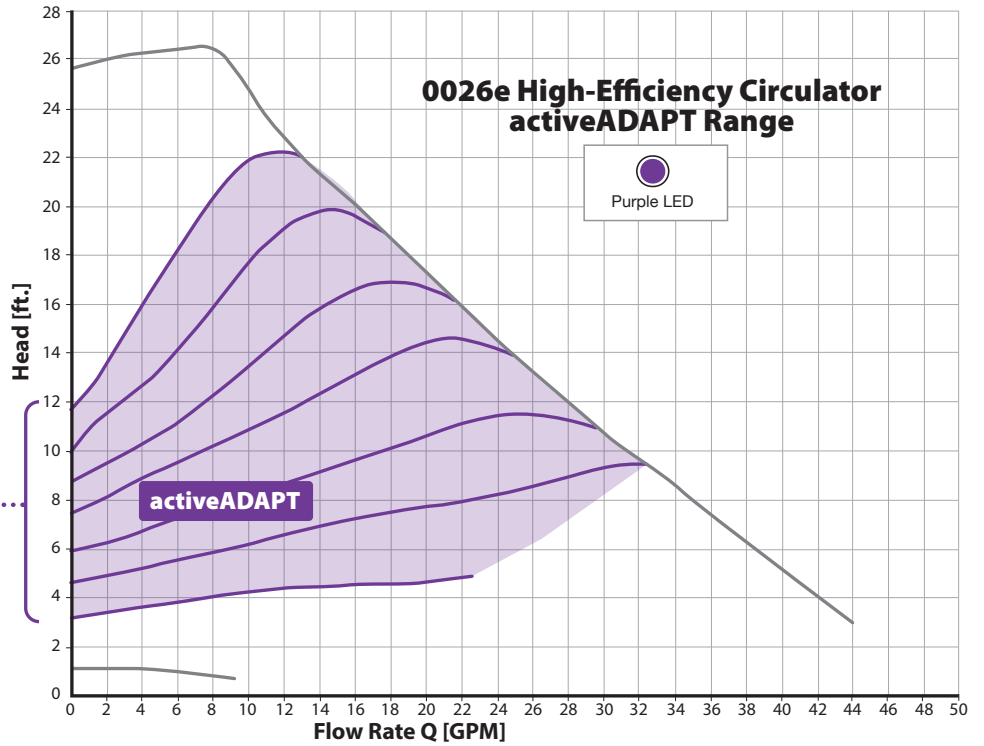
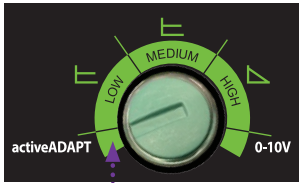

Constant Pressure Mode:

At Low setting the circulator will vary speed to maintain 8 feet of head constant pressure. At Medium setting the circulator will vary speed to maintain 16 feet of head constant pressure.

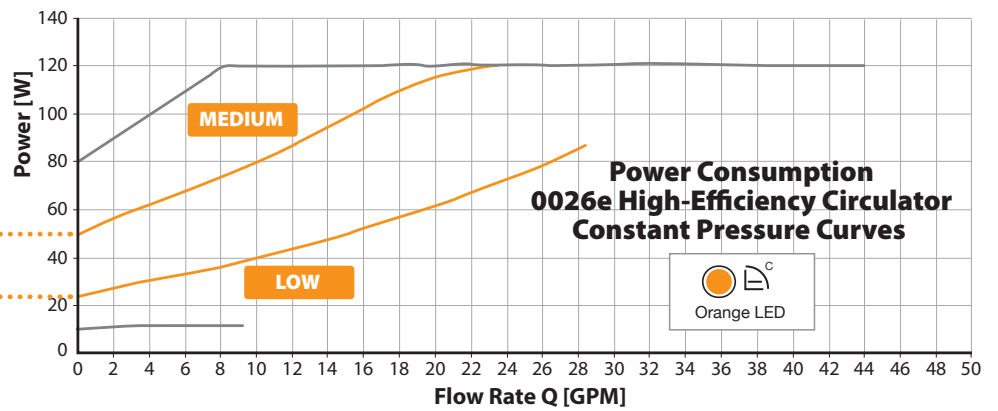
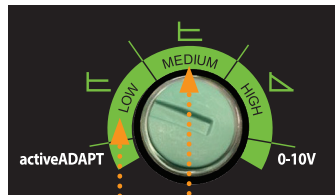
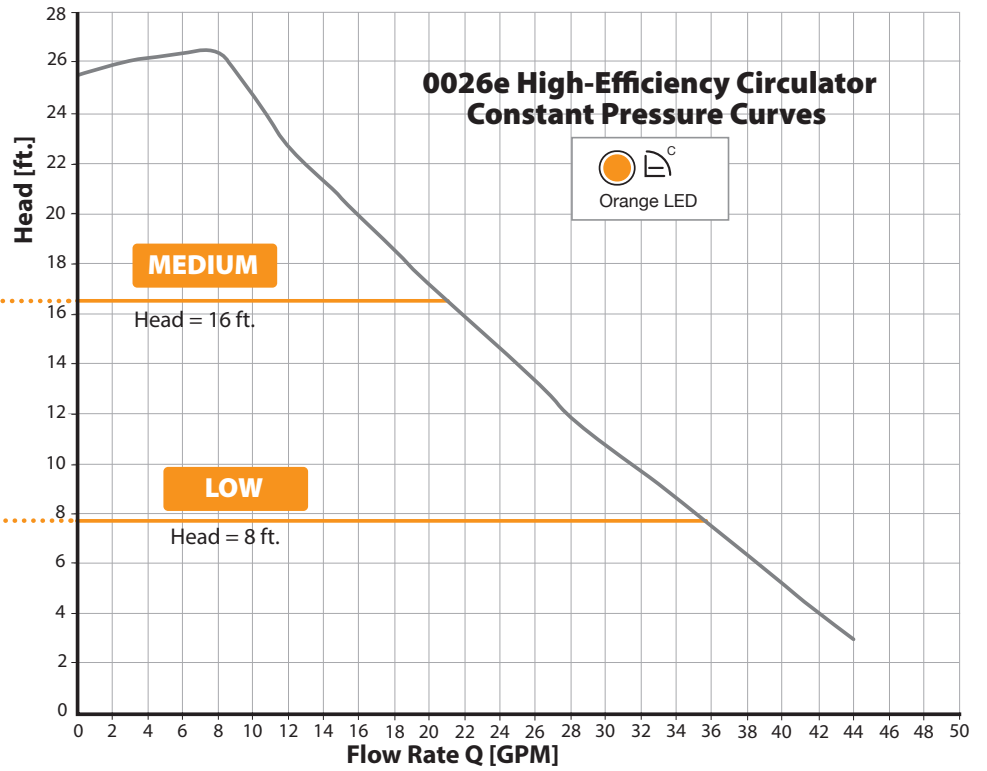
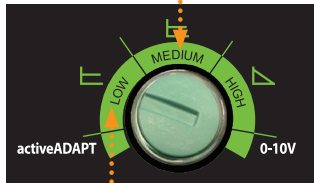

Fixed Speed Mode:

At High setting the circulator always operates at full speed.

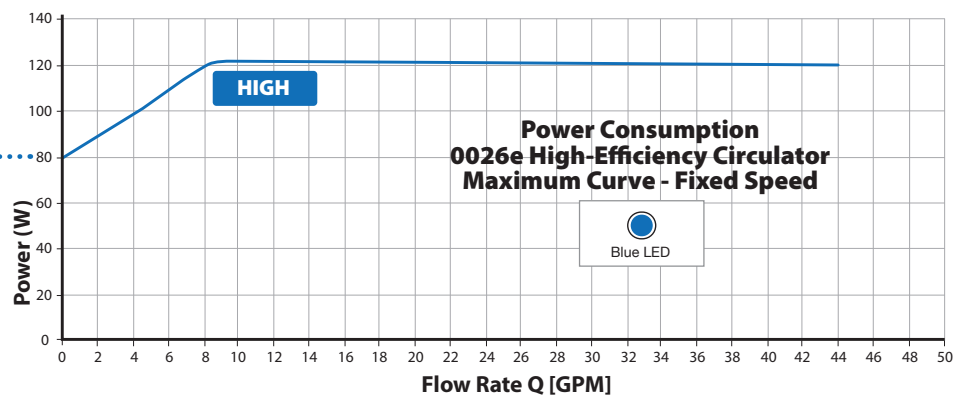
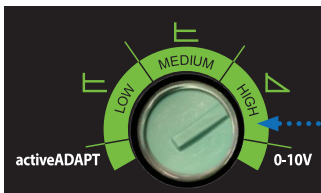
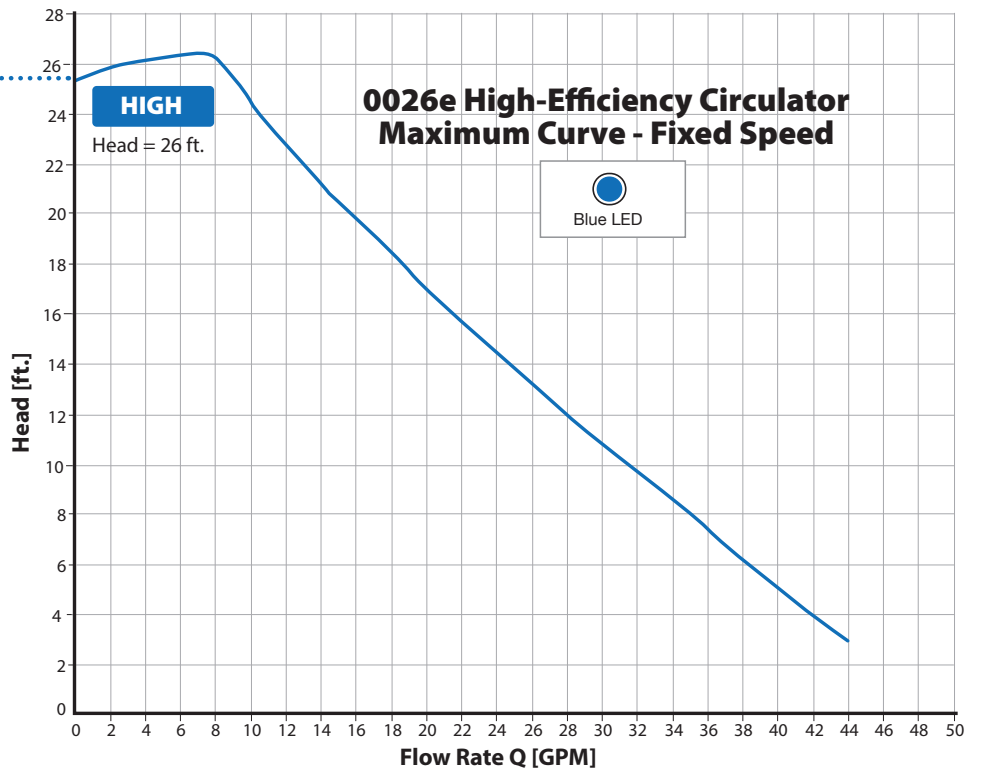
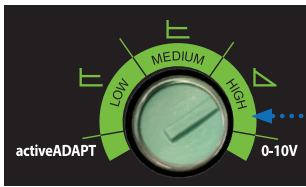

0-10V DC or PWM External Input:

The circulator will vary its speed and performance based on a 0-10V DC analog or PWM digital signal external input.

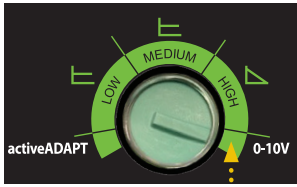

0-10V

PWM (Pulse Width Modulation)

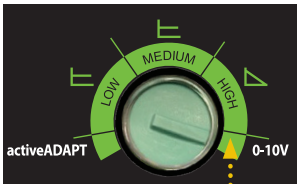
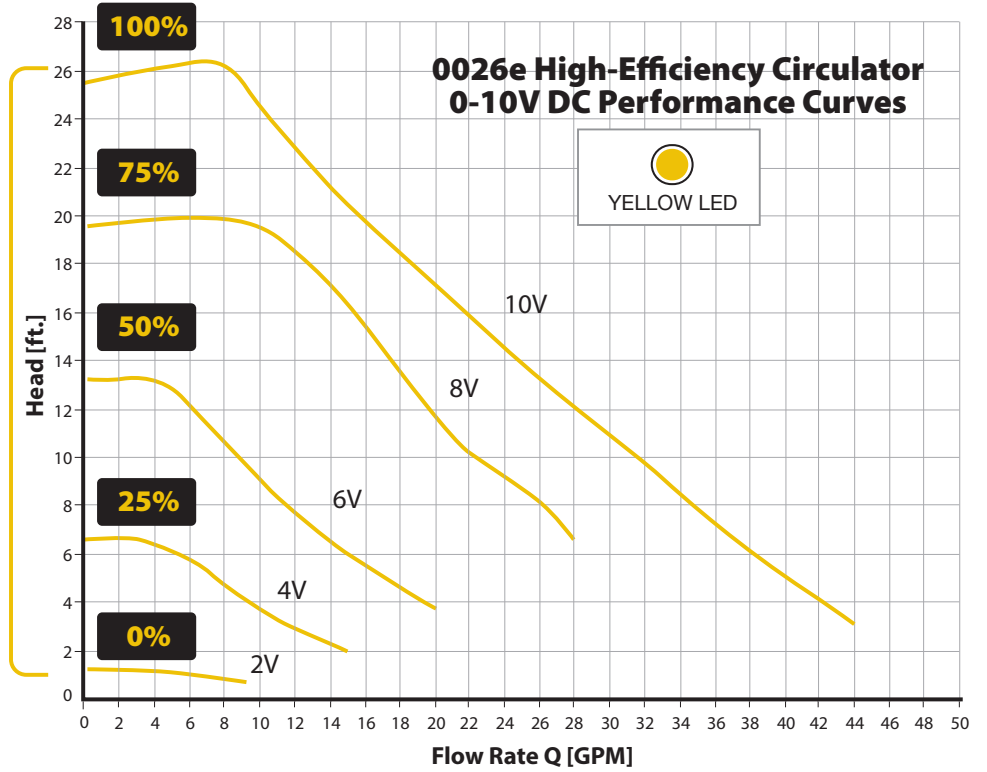

0-10V

Power Consumption
0026e High-Efficiency Circulator
0-10V DC Curves

