

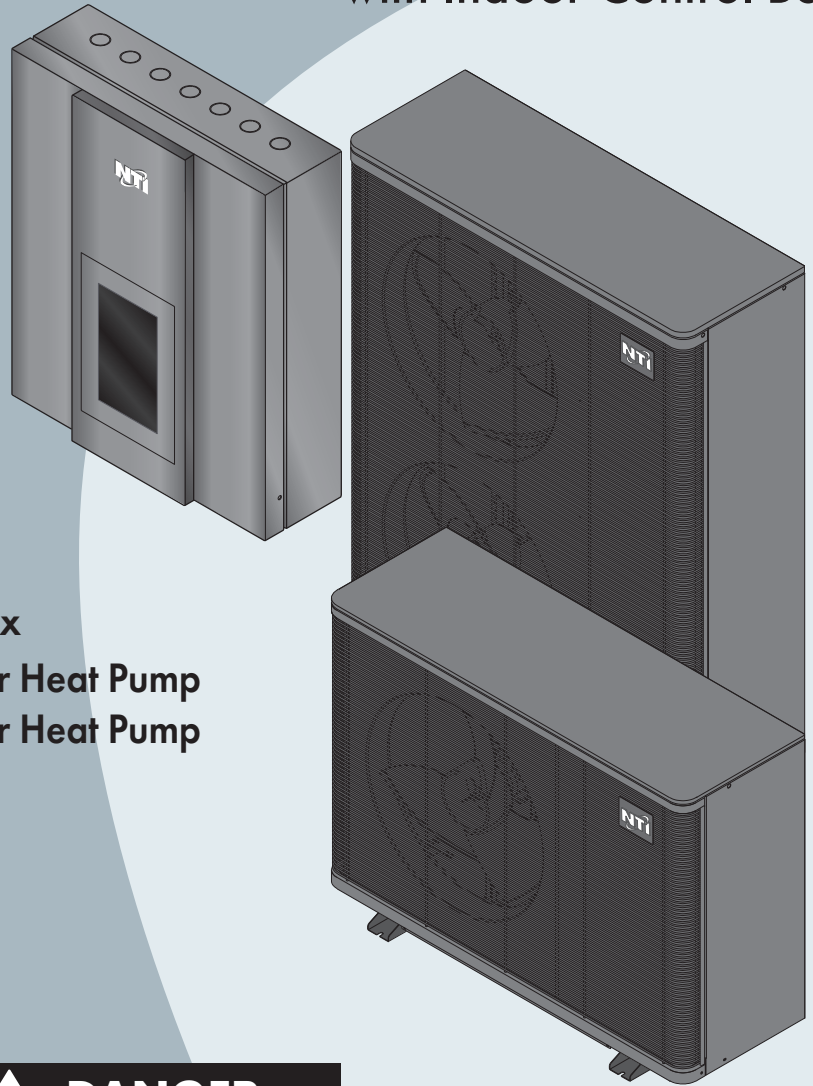

VERTA SERIES

Outdoor Air to Water Heat Pump
with Indoor Control Box

**INSTALLATION
START-UP
MAINTENANCE**



CONTROL32-7 - Indoor Control Box

NHP32-036 - Outdoor Air to Water Heat Pump

NHP32-060 - Outdoor Air to Water Heat Pump



NOTICE

The manufacturer reserves the right to make product changes or updates without notice and will not be held liable for typographical errors in literature.

⚠ DANGER

THIS MANUAL MUST ONLY BE USED BY A QUALIFIED INSTALLER / SERVICE TECHNICIAN. READ ALL INSTRUCTIONS IN THIS MANUAL BEFORE INSTALLING. PERFORM STEPS IN THE GIVEN ORDER. FAILURE TO DO SO COULD RESULT IN SUBSTANTIAL PROPERTY DAMAGE, SEVERE PERSONAL INJURY, OR DEATH.

⚠ WARNING

Improper installation, adjustment, alteration, service, or maintenance could void product warranty and cause property damage, severe personal injury, or death.

California Proposition 65 Warning: This product contains chemicals known to the State of California to cause cancer, birth defects, or other reproductive harm.

SPECIAL ATTENTION BOXES

The following defined terms are used throughout this manual to bring attention to the presence of hazards of various risk levels or to important product information.

DANGER

DANGER indicates an imminently hazardous situation which, if not avoided, will result in serious personal injury or death.

WARNING

WARNING indicates a potentially hazardous situation which, if not avoided, could result in personal injury or death.

CAUTION

CAUTION indicates a potentially hazardous situation which, if not avoided, may result in moderate or minor personal injury.

CAUTION

CAUTION used without the safety alert symbol indicates a potentially hazardous situation which, if not avoided, may result in property damage.

NOTICE

NOTICE is used to address practices not related to personal injury.

Foreword

This manual is intended to be used in conjunction with other literature provided with the product. This includes all related control information. It is important that this manual, all other documents included in this system, and additional local code enforcement, be reviewed in their entirety before beginning any work.

Installation should be made in accordance with the regulations of the Authority Having Jurisdiction, local code authorities, and utility companies which pertain to this type of water heating equipment.

Authority Having Jurisdiction (AHJ) – The AHJ may be a federal, state, provincial, local government, or individual such as a fire chief, fire marshal, chief of a fire prevention bureau, labor department or health department, building official or electrical inspector, or others having statutory authority. In some circumstances, the property owner or his/her agent assumes the role, and at government installations, the commanding officer or departmental official may be the AHJ. NOTE: The manufacturer reserves the right to modify product technical specifications and components without prior notice.

For the Installer

This product must be installed by qualified and licensed personnel. The installer should be guided by the instructions furnished with the product, and by local codes and utility company requirements. In the absence of local codes, preference should be given to the National electrical codes for both US and Canada.

Installations Must Comply With:

- Local/National Electrical Codes
- Local/National Plumbing codes
- Local/National laws, regulations and ordinances

CAUTION

It is the installers responsibility to familiarize the owner/operator with all regularly scheduled maintenance and proper operation of the product.

Part 1 - Before You Start.....	4	Part 5 - Controls	45
1.1 Product Documentation	4	5.1 Main Page	45
1.2 Uncrating the heat pump	4	5.2 Display Symbols	45
1.3 Components	4	5.3 Settings Menu/Symbol	47
1.4 Product documents.....	5	1. Heating/Cooling Circuit 1 (Zone 1)	47
Part 2- General Safety Information.....	7	2. Heating/Cooling Circuit 2 (Zone 2)	49
2.1 Advanced Important Notice.....	7	3. Sanitary Hot Water	50
2.2 Safety precautions	10	4. Working Mode.....	51
Part 3 - Prepare for Installation	11	5. System Settings	52
3.1 Main components	11	6. Timer	53
3.1.1 Indoor Control module (Control32-7)	11	7. Anti-Legionella	53
3.1.2 Outdoor Air to Water Heat Pump.....	11	8. Sleep and Quiet mode	54
3.1.3 Outdoor Unit Main Component	12	9. Vacation	55
3.2 Outlines and dimensions	13	10. Fault Information Query	55
3.3 Specifications	15	11. Parameters Overview	56
3.4 Characteristic curve	16	12. Water Pump Settings	57
3.4.1 Curve of Heating Capacity performance.....	16	13. Eletrical & back-up heater settings.....	59
3.4.2 Curve of COP performance	17	14. Other Settings	60
3.4.3 Curve Cooling Capacity Performance	18	15. Floor Curing	60
3.4.4 Curve of EER Performance.....	19	16. Software Upgrade	61
3.4.5 Flow rate and pressure drop.....	20	17. Frost protection.....	62
3.4.6 Heating and Cooling operating range.....	21	Part 6 - Troubleshooting	63
Part 4 - Installation	22	6.1 Error code	63
4.1 Preliminary Information.....	22	6.2 Troubleshooting 1	80
4.2 Applications	22	6.3 Troubleshooting 2	85
1. Central Heating/Cooling with Buffer Tank	23	Part 7 - Maintenance	87
2. Central Heating-Cooling Hybrid	24	7.1 Maintenance and Precautions for A2L Mildly Flammable Refrigerants (R32):	88
3. Central Heating-Cooling with DHW Indirect.....	27	7.2 General Maintenance	88
4. Central Heating-Cooling with DHW Indirect and Hybrid	28	7.3 Cleaning of water filter	88
4.3 Tools needed	31	7.4 Cleaning of plate heat exchanger	88
4.4 Installation indoor control unit	31	7.5 Condenser coil	88
4.4.1 Choosing an installation location	31	7.6 Gas charging.....	89
4.4.2 Installation Process	31	7.7 Service of monoblock outdoor unit.....	90
4.4.3 Room temperature sensor	32	7.7.1 Maintenance of the electric components.....	90
4.5 Installation outdoor unit.....	32	7.8 Service of monoblock outdoor unit.....	91
4.5.1 Choosing a location for the Outdoor unit.....	32	7.8.1 Maintenance of controller	91
4.5.2 Mounting of outdoor unit.....	33	7.8.2 Replacement of fan motor	92
4.6 Heating /cooling distribution system	33	7.8.3 Replacement of bottom plate heater	93
4.7 Water pipe connection.....	34	Part 8 - Exploded view	93
4.7.1 Filtration.....	34	Part 9 - Warranty.....	94
4.7.2 Insulation	34		
4.7.3 Water Quality Standards.....	34		
4.8 Wiring diagram.....	35		
4.9 Wiring.....	38		
4.9.1 Explanation of terminals	38		
4.9.2 Wiring Preliminary Precautions.....	40		
4.9.3 Suggested wiring locations.....	40		
4.9.4 Wiring Process	43		
4.10 Test run	44		
4.10.1 Before start-up.....	44		
4.10.2 Starting Up	44		
4.11 Air Purge Procedure for the Water System.....	44		

Part 1 - Before You Start

1.1 Product description

NHP32-036 - Outdoor Air to Water Heat Pump

NHP32-060 - Outdoor Air to Water Heat Pump

The outdoor unit captures heat from the environment and transfers it to the building's heating circuit.

Low-temperature air heat is transferred to the heat pump system through an evaporator containing a refrigerant. As the refrigerant evaporates, it transforms into a gas.

The compressor draws in the gas, elevates its temperature, and directs it to the condenser. In the condenser, heat is transferred to the water in the central heating system.

The cooled liquid flows through the expansion valve and returns to the evaporator, completing the cycle.

In cooling mode, the cycle reverses, extracting heat from the building and discharging it outside.

CONTROL32-7 - Indoor Control Box

The indoor unit operates based on the demand-dependent capacity control of the heat pump compressor, activated by the controller of the indoor module.

The indoor module controller regulates the heating output according to a predefined heating curve. If the heat pump is unable to meet the building's heating demand independently, the controller automatically activates the electrical auxiliary heater. This heater, in conjunction with the heat pump, produces the desired heating medium temperature.

1.2 Uncrating the heat pump

Remove the packaging with suitable means, taking care not to damage the appliance.

NOTICE

UNCRATING THE HEAT PUMP - Any claims for damage or shortage in shipment must be filed immediately against the transportation company by the consignee.

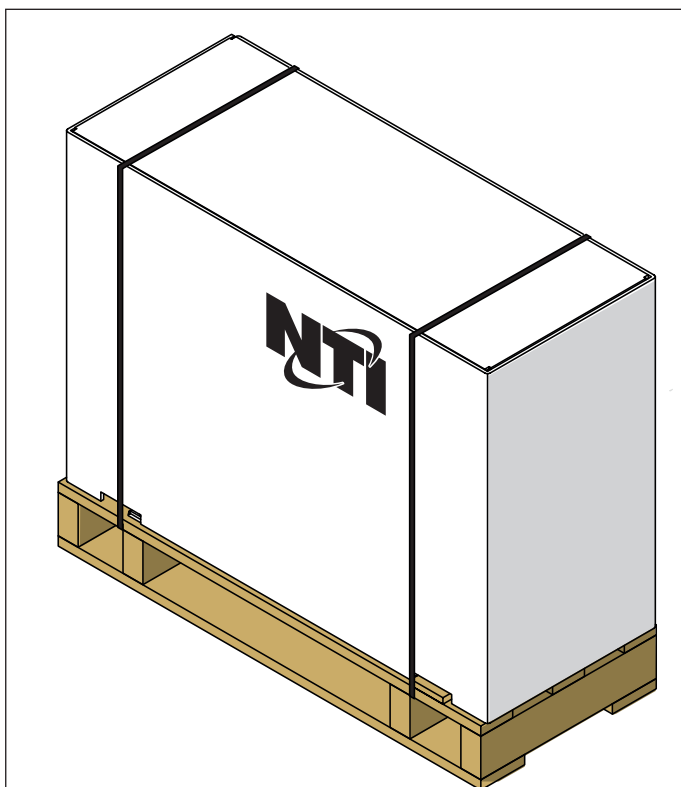

Figure 1 - Outdoor Air to Water Heat Pump Packaging

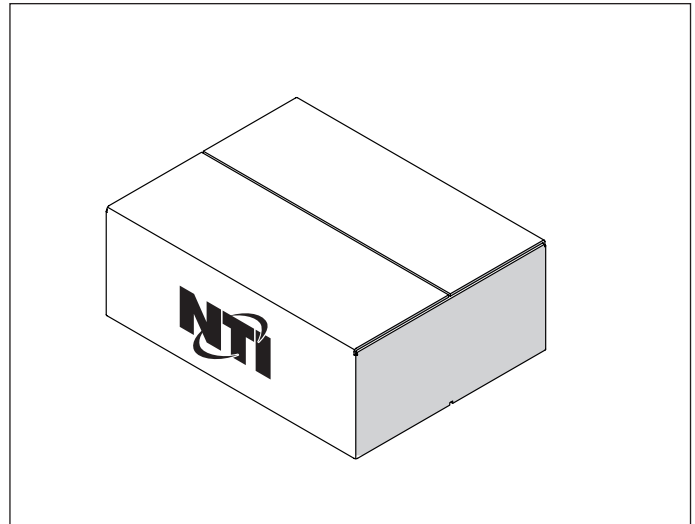

Figure 2 - Indoor Control Unit Packaging

! WARNING

Upon receipt of the product, ensure that the product is intact and complete and, in the event of non-compliance with what was ordered, contact the Agency that sold the appliance.

IT IS FORBIDDEN to dispose of packaging material in the environment or leave it within the reach of children as it may be a potential source of danger.

The appliance must be lifted using only suitable lifting equipment such as hoists or forklifts with a capacity adequate for the weight to be lifted.

1.3 Components

Description	Q.ty
CONTROL32-7 - Indoor Control Box	1

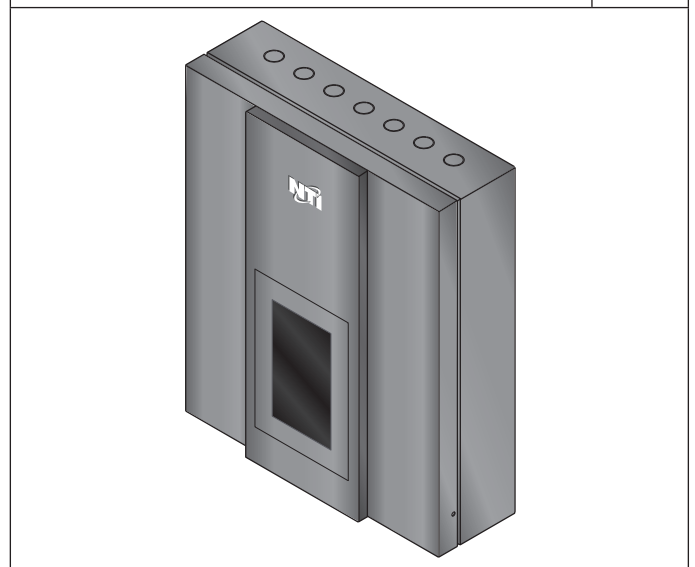

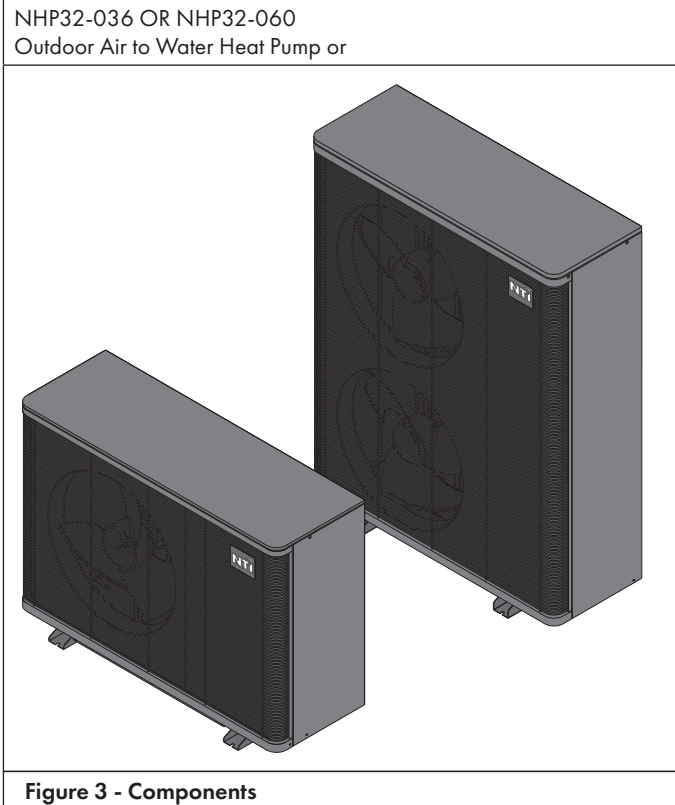







Accessories		
PO-water pump PWM signal cable	1	
Mounting screws to mount the control box to the wall	3	
Lock Washer Required to secure the shielded communication cable to ground.	2	
Copper screws Required to secure shielded communication cable to ground	2	

Table 1 - Accessories

NOTICE

All above accessories are provided with every unit. If something is missing or damaged, please contact the proper purchasing channels to alert the manufacturer.

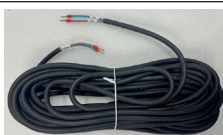
Accessories		
User's manual	1	
Replacement parts manual	1	
TR-Room temperature sensor (NTC - 5K)	1	
TC-water temperature sensor for cooling and heating (PT1000)	1	
TW-water temperature sensor for sanitary hot water (PT1000)	1	
TV1-water temperature sensor after mixture valve 1 TV2-water temperature sensor after mixture valve 2 (NTC - 5K)	2	
Communication cable between indoor control unit and 1 monoblock unit (32ft supplied with the packaging. Cable can be extended to a maximum distance of 100ft)	1	
Sensor extension connection cable: TV2, TV1, TR, TC, TW	5	
PO-water pump power supply cable	1	

1.4 Product documents

The instructions contained in the manual are related to the products listed in the table:

Code	Description
4147089	CONTROL 32-7
4147091	NHP32-036
4147092	NHP32-060

It's possible to combine the differents codes as listed in the table:

Possible combinations	
4147089 CONTROL 32-7	4147091 NHP32-036
4147089 CONTROL 32-7	4147092 NHP32-060

! CAUTION

1. Do not use means to accelerate the defrosting process or to clean, other than those recommended by the manufacturer.
2. This appliance is not intended for use by persons (including children) with reduced physical, sensory or mental capabilities, or lack of experience and knowledge, unless they have been given supervision or instruction concerning use of the appliance by a person responsible for their safety.
3. Children should be supervised to ensure that they do not play with the appliance.
4. If the power supply is damaged, it must be replaced by the manufacturer, its service agent or similarly qualified persons in order to avoid a hazard
5. The appliance shall be stored in a room without continuously operating ignition sources (for example: open flames, an operating gas appliance or an operating electric heater.).
6. Be aware that refrigerants may not contain an odour.
7. Spaces where refrigerant pipes shall be compliance with national refrigerant regulations.
8. Servicing shall be performed only as recommended by the manufacturer.
9. The appliance shall be stored in a well-ventilated area where the room size corresponds to the room area as specified for operation.
10. All safety or performance related work must be carried out by qualified personnel.

! WARNING

The appliance shall be stored in a room without continuously operating ignition sources (for example: open flames, an operating gas appliance or an operating electric heater).
Do not pierce or burn.
Be aware that refrigerants may not contain an odour.
Pipe-work including piping material, pipe routing, and installation shall include protection from physical damage in operation and service, and be in compliance with national and local codes and standards, such as ASHRAE 15, ASHRAE 15.2, IAPMO Uniform Mechanical Code, ICC International Mechanical Code, or CSA B52. All field joints shall be accessible for inspection prior to being covered or enclosed.

! WARNING

CONTROL32-7 - Indoor Control Box

- **INGESTION HAZARD:** This product contains a button cell or coin battery.
- **DEATH** or serious injury can occur if ingested.
- A swallowed button cell or coin battery can cause **Internal Chemical Burns** in as little as **2 hours**.
- **KEEP** new and used batteries **OUT OF REACH of CHILDREN**.
- **Seek immediate medical attention** if a battery is suspected to be swallowed or inserted inside any part of the body.
Note: Only battery type CR2025 is compatible with the remote controller.
The nominal battery voltage should be 3V.
This product contains non-replaceable batteries.

Remove and immediately recycle or dispose of used batteries according to local regulations and keep away from children. Do NOT dispose of batteries in household trash or incinerate. Even used batteries may cause severe injury or death. Call a local poison control center for treatment information. A statement indicating the compatible battery type, CR2032. Nominal voltage : 3V. Non-rechargeable batteries are not to be recharged. Do not force discharge, recharge, disassemble, heat above (-22-140°F) or incinerate. Doing so may result in injury due to venting, leakage or explosion resulting in chemical burns.

! WARNING

The coin cell battery is not user replaceable

2.1 Advanced Important Notice

NHP outdoor air to water heat pumps are considered “monobloc” type units which mean they have all refrigerant contained and pre-charged from the factory. In the rare occurrence where a field repair is required, all piping shall be pressure tested with an inert gas and then vacuum tested prior to refrigerant charging, according to the following requirements.

The minimum test pressure for the low side of the system shall be the low side design pressure and the minimum test pressure for the high side of the system shall be the high side design pressure, unless the high side of the system, cannot be isolated from the low side of the system in which case the entire system shall be pressure tested to the low side design pressure.

General Notice:

Transport of equipment containing flammable refrigerants

Attention is drawn to the fact that additional transportation regulations may exist with respect to equipment containing flammable gas. The maximum number of pieces of equipment or the configuration of the equipment permitted to be transported together will be determined by the applicable transport regulations.

Marking of equipment using signs

- * Signs for similar appliances used in a work area are generally addressed by local regulations and give the minimum requirements for the provision of safety and/or health signs for a work location.
- * The effectiveness of signs should not be diminished by too many signs being placed together.
- * Any pictograms used should be as simple as possible and contain only essential details.

Disposal of equipment using flammable refrigerants

Compliance with national regulations.

Storage of equipment/appliances

The storage of the appliance should be in accordance with the applicable regulations or instructions, whichever is more stringent.

Storage of packed (unsold) equipment

Storage package protection should be constructed in such a way that mechanical damage to the equipment inside the package will not cause a leak of the REFRIGERANT CHARGE. The maximum number of pieces of equipment permitted to be stored together will be determined by local regulations. The outdoor unit must always be stored and shipped in an upright position. Failure to adhere to this may result in damage and improper performance of the system.

Unventilated areas

For model NHP32-036/NHP32-060:

These appliances operate using FLAMMABLE REFRIGERANTS and under no circumstances should the appliance be installed in an unventilated area. If installed in an unventilated area, the warranty will be void and there could be serious safety risk for the installation.

Qualification of workers

Every working procedure that affects safety means shall only be carried out by competent persons with relevant qualifications. (ect. Refrigeration technicians, licensed plumbing contractor, HVAC contractors, licensed electricians).

All personnel working on this product should hold the appropriate license or certification required by local jurisdictions.

Failure to comply could result in serious injury and/or death.

Failure to comply will result in void of warranty.

When operating the equipment, the power supply of the whole unit must be cut off, and the operation must be carried out in strict accordance with the equipment safety requirements.

Examples for such working procedures are:

- breaking into the refrigerating circuit;
- opening of sealed components;
- opening of ventilated enclosures.

Information on servicing

1. Checks to the area

Prior to beginning work on systems containing FLAMMABLE REFRIGERANTS (A2L), safety checks are necessary to ensure that the risk of ignition is minimised. For repair to the refrigeration system, the following precautions shall be complied with prior to conducting work on the system.

2. Work procedure

Work shall be undertaken under a controlled procedure so as to minimize the risk of a flammable gas or vapour being present while the work is being performed.

3. General work area

All maintenance staff and others working in the local area shall be instructed on the nature of work being carried out. Work in confined spaces shall be avoided.

4. Checking for presence of refrigerant

The area shall be checked with an appropriate refrigerant detector prior to and during work, to ensure the technician is aware of potentially toxic or flammable atmospheres. Ensure that the leak detection equipment being used is suitable for use with all applicable refrigerants, i.e. non-sparking, adequately sealed or intrinsically safe.

5. Presence of fire extinguisher

If any hot work (for example, brazing or soldering) is to be conducted on the refrigeration equipment or any associated parts, appropriate fire extinguishing equipment shall be available to hand. Have a dry powder or CO2 fire extinguisher adjacent to the charging area.

6. No ignition sources

No person carrying out work in relation to the refrigeration SYSTEM which involves exposing any pipe work shall use any sources of ignition in such a manner that it may lead to the risk of fire or explosion. All possible ignition sources, including cigarette smoking, should be kept sufficiently far away from the site of installation, repairing, removing and disposal, during which refrigerant can possibly be released to the surrounding space. Prior to work taking place, the area around the equipment is to be surveyed to make sure that there are no flammable hazards or ignition risks. “No Smoking” signs shall be displayed.

7. Ventilated area

Ensure that the area is in the open or that it is adequately ventilated before breaking into the system or conducting any hot work. A degree of ventilation shall continue during the period that the work is carried out. The ventilation should safely disperse any released refrigerant and preferably expel it externally into the atmosphere.

8. Checks to the refrigeration equipment

Where refrigeration components are being changed, they shall be fit for the purpose and to the correct specification. At all times the manufacturer’s maintenance and service guidelines shall be followed. If in doubt, consult the manufacturer’s technical department for assistance.

Part 2 - General Safety Information

9. Checks to electrical devices

Repair and maintenance to electrical components shall include initial safety checks and component inspection procedures. If a fault exists that could compromise safety, then no electrical supply shall be connected to the circuit until it is satisfactorily dealt with. This shall be reported to the owner of the equipment so all parties are advised.

Initial safety checks shall include:

- that capacitors are discharged: this shall be done in a safe manner to avoid possibility of sparking;
- that no live electrical components and wiring are exposed while charging, recovering or purging the system;
- that there is continuity of earth bonding.

Sealed electrical components shall be replaced

1. During repairs to sealed components, all electrical supplies shall be disconnected from the equipment being worked upon prior to any removal of sealed covers, etc. If it is absolutely necessary to have an electrical supply to equipment during servicing, then a permanently operating form of leak detection shall be located at the most critical point to warn of a potentially hazardous situation.
2. Particular attention shall be paid to the following to ensure that by working on electrical components, the casing is not altered in such a way that the level of protection is affected. This shall include damage to cables, excessive number of connections, terminals not made to original specification, damage to seals, incorrect fitting of glands, etc.
3. Ensure that the apparatus is mounted securely.
4. Ensure that seals or sealing materials have not degraded to the point that they no longer serve the purpose of preventing the ingress of flammable atmospheres. Replacement parts shall be in accordance with the manufacturer's specifications.

Intrinsically safe components must be replaced

1. Do not apply any permanent inductive or capacitance loads to the circuit without ensuring that this will not exceed the permissible voltage and current permitted for the equipment in use.
2. Intrinsically safe components are the only types that can be worked on while live in the presence of a flammable atmosphere. The test apparatus shall be at the correct rating.
3. Replace components only with parts specified by the manufacturer. Other parts may result in the ignition of refrigerant in the atmosphere from a leak.

NOTE: The use of silicon sealant can inhibit the effectiveness of some types of leak detection equipment. Intrinsically safe components do not have to be isolated prior to working on them.

Wiring

Check that wiring will not be subject to wear, corrosion, excessive pressure, vibration, shock or any other adverse environmental effects. The check shall also take into account the effect or continual vibration from sources such as compressors or fans.

Detection of flammable refrigerants

1. Under no circumstances shall potential sources of ignition be used in the searching for or detection of refrigerant leaks. A halide torch (or any other detector using a naked flame) shall not be used
2. The following leak detection methods are deemed acceptable for all refrigerant systems.
3. Electronic leak detectors may be used to detect refrigerant leaks but, in the case of FLAMMABLE REFRIGERANTS, the sensitivity may not be adequate, or may need re-calibration (Detection equipment shall be calibrated in a refrigerant-free area). Ensure that the detector a potential source of ignition and is suitable for the refrigerant used. Leak detection equipment shall be set at a percentage of the LFL of the refrigerant and shall be calibrated to the refrigerant employed, and the appropriate percentage of gas (25 % maximum) is confirmed.
4. Leak detect fluids are also suitable for use with most refrigerants but the use of detergents containing chlorine shall be avoided as the chlorine may react with the refrigerant and corrode the copper pipe-work.
5. **NOTE** - Examples of leak detection fluids are
 - bubble method,
 - fluorescent method agents
6. If a leak is suspected, all naked flames shall be removed/ extinguished.
7. If a leakage of refrigerant is found which requires brazing, all of the refrigerant shall be recovered from the system, or isolated (by means of shut off valves) in a part of the system remote from the leak. Removal of refrigerant shall be according to below removal and evacuation instruction.

Removal and evacuation

- 1) When breaking into the refrigerant circuit to make repairs – or for any other purpose – conventional procedures shall be used. However, for flammable refrigerants it is important that best practice be followed, since flammability is a consideration. The following procedure shall be adhered to:
 - safely remove refrigerant following local and national regulations;
 - evacuate;
 - purge the circuit with inert gas;
 - evacuate;
 - continuously flush or purge with inert gas when using flame to open circuit; and;
 - open the circuit
2. The refrigerant charge shall be recovered into the correct recovery cylinders if venting is not allowed by local and national codes. For appliances containing flammable refrigerants, the system shall be purged with oxygen-free nitrogen to render the appliance safe for flammable refrigerants. This process might need to be repeated several times. Compressed air or oxygen shall not be used for purging refrigerant systems.
3. For appliances containing flammable refrigerants, refrigerants purging shall be achieved by breaking the vacuum in the system with oxygen-free nitrogen and continuing to fill until the working pressure is achieved, then venting to atmosphere, and finally pulling down to a vacuum (optional for A2L). This process shall be repeated until no refrigerant is within the system (optional for A2L). When the final oxygen-free nitrogen charge is used, the system shall be vented down to atmospheric pressure to enable work to take place.
4. The outlet for the vacuum pump shall not be close to any potential ignition sources, and ventilation shall be available.

Charging procedures

In addition to conventional charging procedures, the following requirements shall be followed.

- Ensure that contamination of different refrigerants does not occur when using charging equipment. Hoses or lines shall be as short as possible to minimise the amount of refrigerant contained in them.
- Cylinders shall be kept in an appropriate position according to the instructions.
- Ensure that the Refrigeration System is grounded prior to charging the system with refrigerant.
- Label the system when charging is complete (if not already).
- Extreme care shall be taken not to overfill the Refrigeration System.

Prior to recharging the system, it shall be pressure-tested with the appropriate purging gas. The system shall be leak-tested on completion of charging but prior to commissioning. A follow up leak test shall be carried out prior to leaving the site.

Decommissioning

Before carrying out this procedure, it is essential that the technician is completely familiar with the equipment and all its detail. It is recommended good practice that all refrigerants are recovered safely. Prior to the task being carried out, an oil and refrigerant sample shall be taken in case analysis is required prior to re-use of recovered refrigerant. It is essential that electrical power is available before the task is commenced.

- a. Become familiar with the equipment and its operation.
- b. Isolate system electrically.
- c. Before attempting the procedure, ensure that:
 - mechanical handling equipment is available, if required, for handling refrigerant cylinders;
 - all personal protective equipment is available and being used correctly;
 - the recovery process is supervised at all times by a competent person;
 - recovery equipment and cylinders conform to the appropriate standards
- d) Pump down refrigerant system, if possible.
- e) If a vacuum is not possible, make a manifold so that refrigerant can be removed from various parts of the system.
- f) Make sure that cylinder is situated on the scales before recovery takes place.
- g) Start the recovery machine and operate in accordance with instructions.
- h) Do not overfill cylinders (no more than 80 % volume liquid charge).
- i) Do not exceed the maximum working pressure of the cylinder, even temporarily.
- j) When the cylinders have been filled correctly and the process completed, make sure that the cylinders and the equipment are removed from site promptly and all isolation valves on the equipment are closed off.
- k) Recovered refrigerant shall not be charged into another Refrigeration System unless it has been cleaned and checked.

Labelling

Equipment shall be labelled stating that it has been de-commissioned and emptied of refrigerant. The label shall be dated and signed. For appliances containing **FLAMMABLE REFRIGERANTS**, ensure that there are labels on the equipment stating the equipment contains FLAMMABLE REFRIGERANT.

Recovery

1. When removing refrigerant from a system, either for servicing or decommissioning, it is recommended good practice that all refrigerants are removed safely.
2. When transferring refrigerant into cylinders, ensure that only appropriate refrigerant recovery cylinders are employed. Ensure that the correct number of cylinders for holding the total system charge is available. All cylinders to be used are designated for the recovered refrigerant and labelled for that refrigerant (i.e. special cylinders for the recovery of refrigerant). Cylinders shall be complete with pressure-relief valve and associated shut-off valves in good working order. Empty recovery cylinders are evacuated and, if possible, cooled before recovery occurs.
3. The recovery equipment shall be in good working order with a set of instructions concerning the equipment that is at hand and shall be suitable for the recovery of the flammable refrigerant. If in doubt, the manufacturer should be consulted. In addition, a set of calibrated weighing scales shall be available and in good working order. Hoses shall be complete with leak-free disconnect couplings and in good condition.
4. The recovered refrigerant shall be processed according to local legislation in the correct recovery cylinder, and the relevant waste transfer note arranged. Do not mix refrigerants in recovery units and especially not in cylinders.
5. If compressors or compressor oils are to be removed, ensure that they have been evacuated to an acceptable level to make certain that flammable refrigerant does not remain within the lubricant. The compressor body shall not be heated by an open flame or other ignition sources to accelerate this process. When oil is drained from a system, it shall be carried out safely.

WARNING

- **Warning:** keep any required ventilation openings clear of obstruction.
- **Notice:** servicing shall be performed only as recommended by the manufacturer.
- **Warning:** The appliance shall be stored in a well-ventilated area where the room size corresponds to the room area as specified for operation.
- **Warning:** The appliance shall be stored in a room without continuously operating open flames (for example an operating gas appliance) and ignition sources (for example an operating electric heater).

Do not use means to accelerate the defrosting process or to clean, other than those recommended by the manufacturer.
 The appliance shall be stored in a room without continuously operating ignition sources (for example: open flames, an operating gas appliance or an operating electric heater).
 Do not pierce or burn.
 Be aware that refrigerants may not contain an odour.

Part 2 - General Safety Information

2.2 Safety precautions

THE FOLLOWING WARNINGS ARE VERY IMPORTANT. PLEASE BE SURE TO UNDERSTAND THEIR MEANING, WHICH CONCERNS THE PRODUCT AND YOUR PERSONAL SAFETY.

WARNING

The installation, dismantlement and maintenance of the equipment must be performed by qualified personnel. It is forbidden to do any changes to the structure of the unit. Otherwise injury of person or unit damage might happen.

To avoid electrical shock, make sure to disconnect the power supply 1 minute or more before servicing the electrical parts. Even after 1 minute, always measure the voltage at the terminals of main circuit capacitors or electrical parts and, before touching, make sure that those voltages are lower than the safety voltage.

Be sure to read this manual before use.

For sanitary hot water, please always add a thermostatic mixing valve before water tap and set it to proper temperature.

Each outdoor unit, and indoor unit, will require a separate/dedicated power source. Failure to provide will result in poor unit performance and possible malfunctions of the products.

The power supply to the unit must be grounded.

This appliance can be used by children aged from 8 years and above and persons with reduced physical, sensory or mental capabilities or lack of experience and knowledge if they have been given supervision or instruction concerning use of the appliance in a safe way and understand the hazards involved. Children shall not play with the appliance. Cleaning and user maintenance shall not be made by children without supervision.

CAUTION

All independent electric circuits require a specific dedicated circuit breaker. This includes the following circuits

- Outdoor unit
- Indoor distribution main control
- Indoor distribution electric heater
- Indoor distribution back up heater
- Indoor distribution auxiliary heater

Please refer to the specifications table located in this manual for proper circuit breaker sizing.

Disposal of Scrap Batteries(if there is).Please discard the batteries as sorted municipal waste at the accessible collection point.

DANGER

Do not touch the air outlet grill when fan motor is running.

If any factory wiring is damaged, it must be replaced by the manufacturer, its service agent or similarly qualified persons in order to avoid a hazard.

Installer must select the correct breaker as per recommended. Steel wire or copper wire cannot be taken as substitute for fuse or breaker. Otherwise, damages may be caused.

The fins on the outdoor units can be very sharp. Please take care when handling to product to not cut fingers. Proper PPE (gloves) should be used when handling.

3.1 Main components

3.1.1 Indoor Control box (Control32-7)

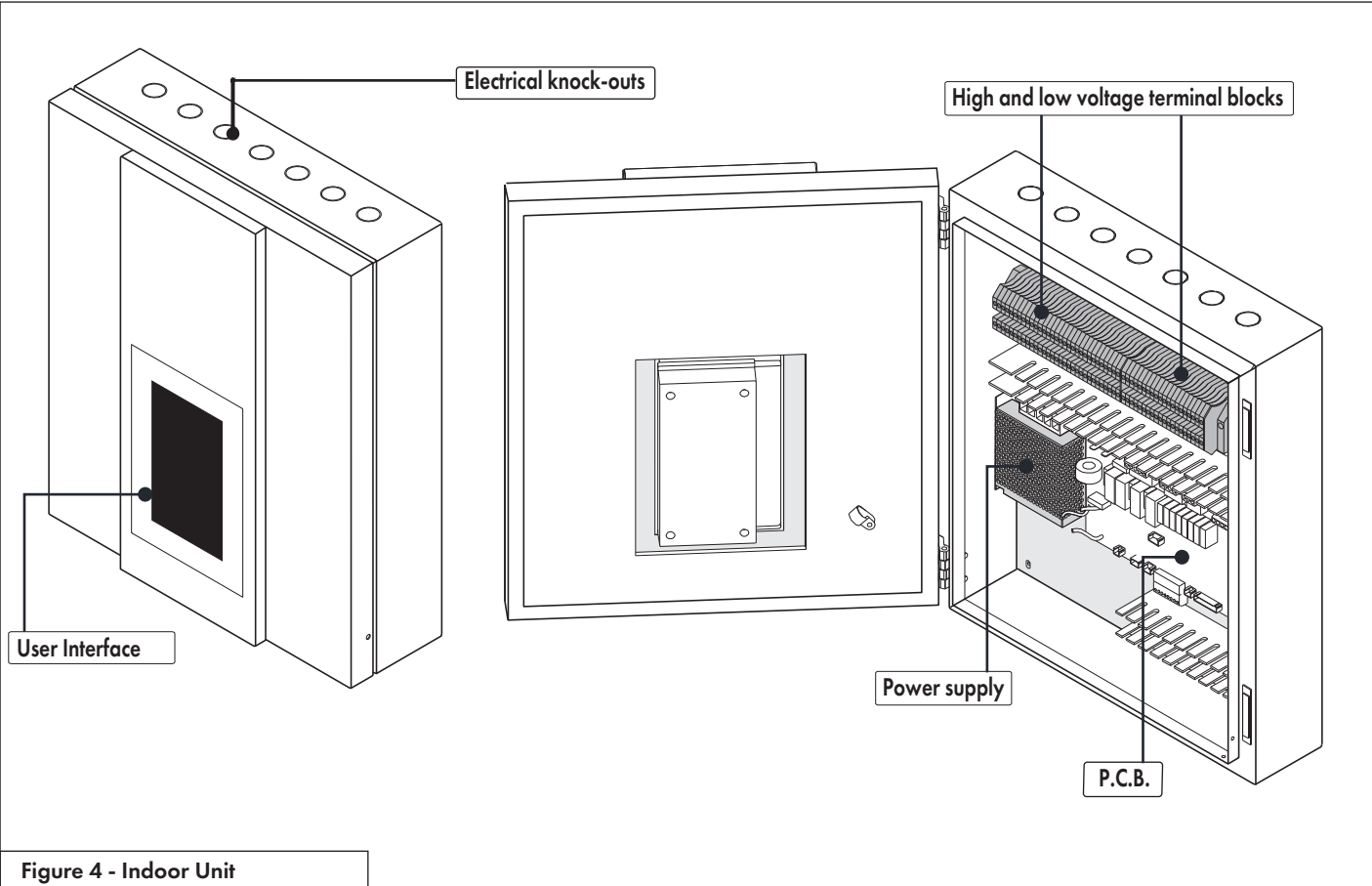

3.1.2 Outdoor Air to Water Heat Pump

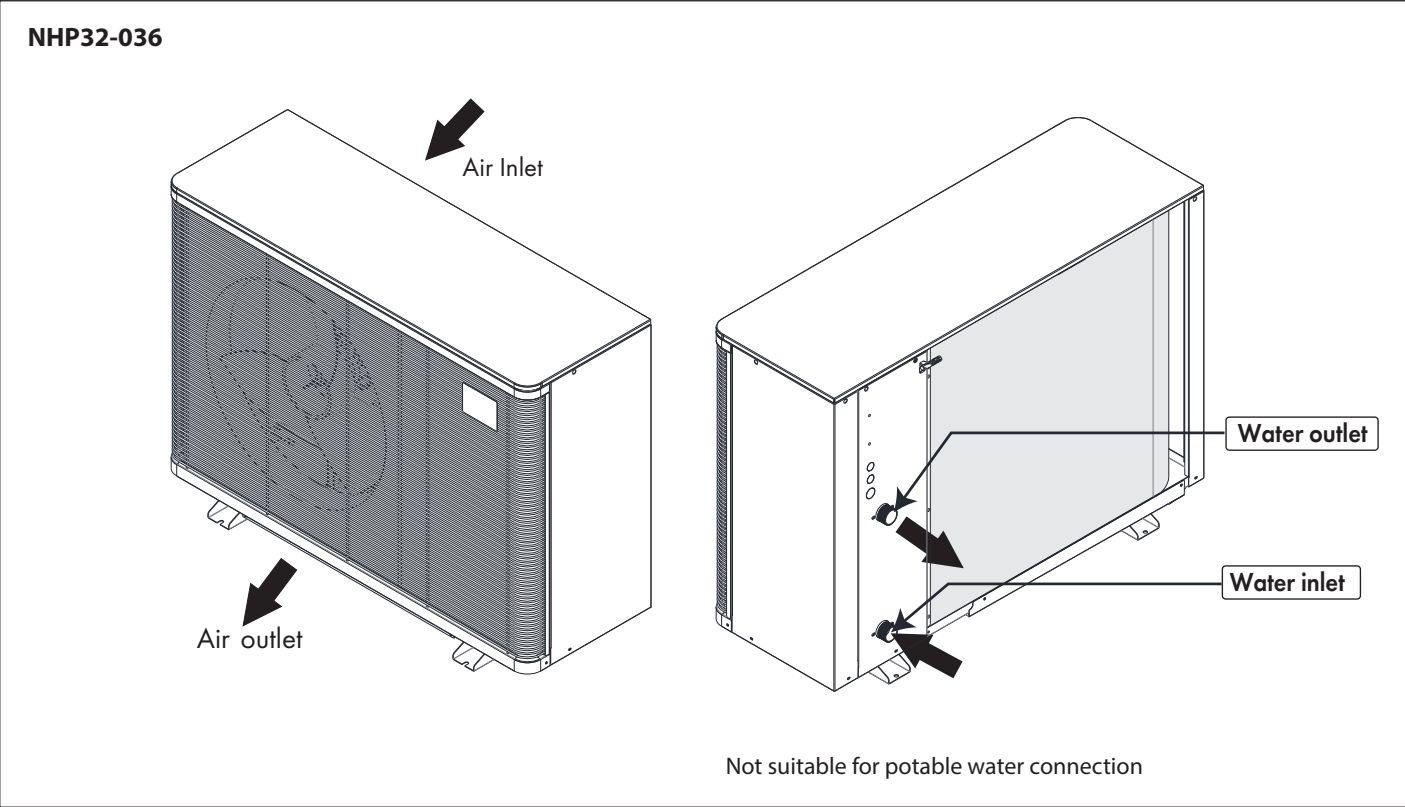

Part 3 - Prepare for Installation

NHP32-060

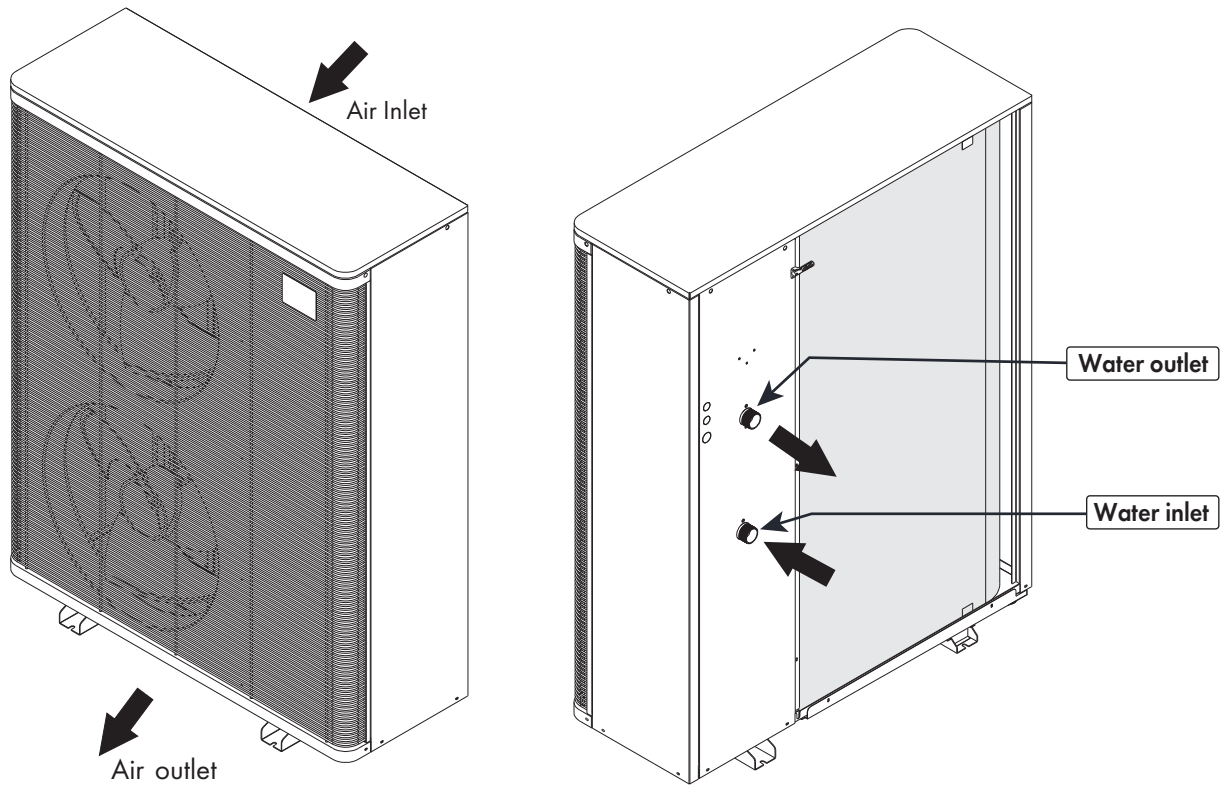

Figure 5 - Outdoor Unit

3.1.3 Outdoor Unit Main Component

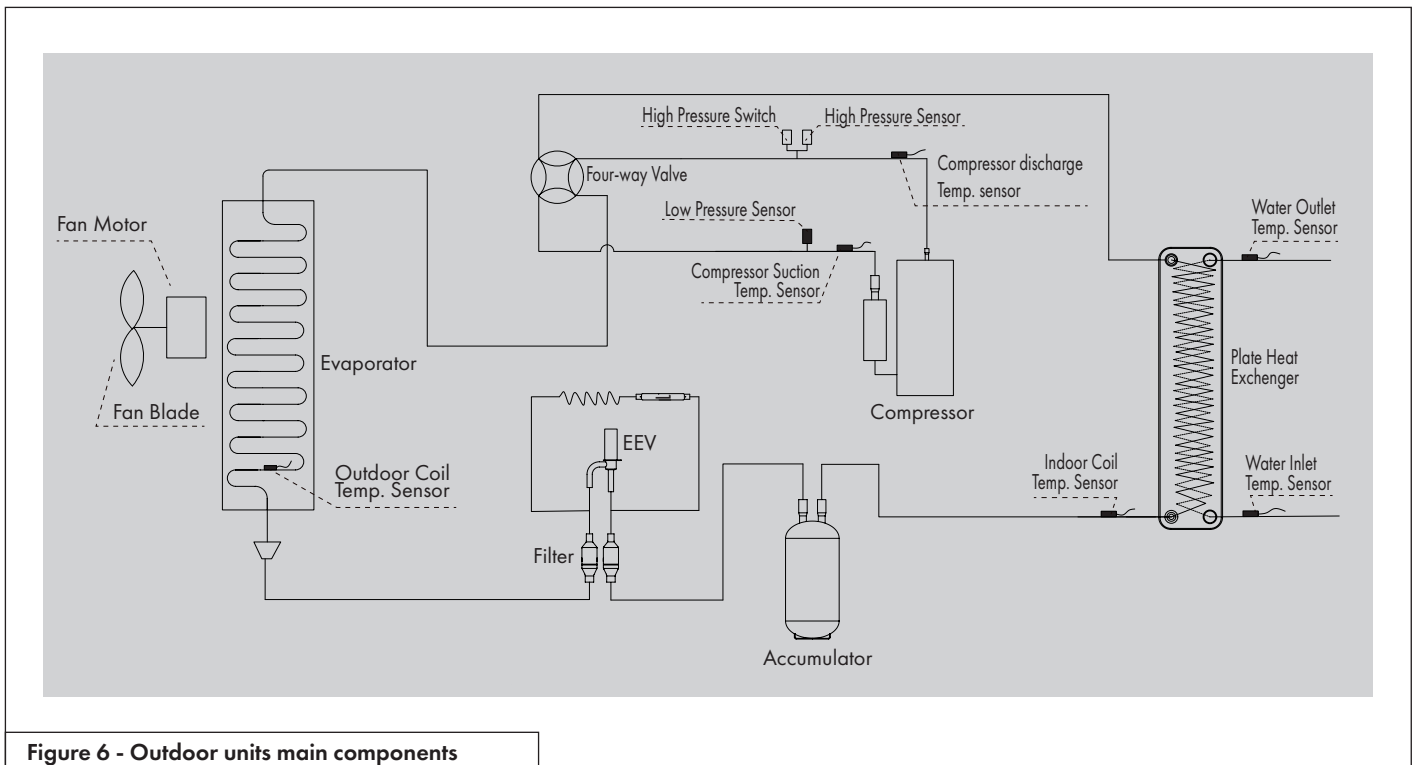

Figure 6 - Outdoor units main components

3.2 Outlines and dimensions

Unit: inches (mm)

Indoor Control Box (Control32-7)

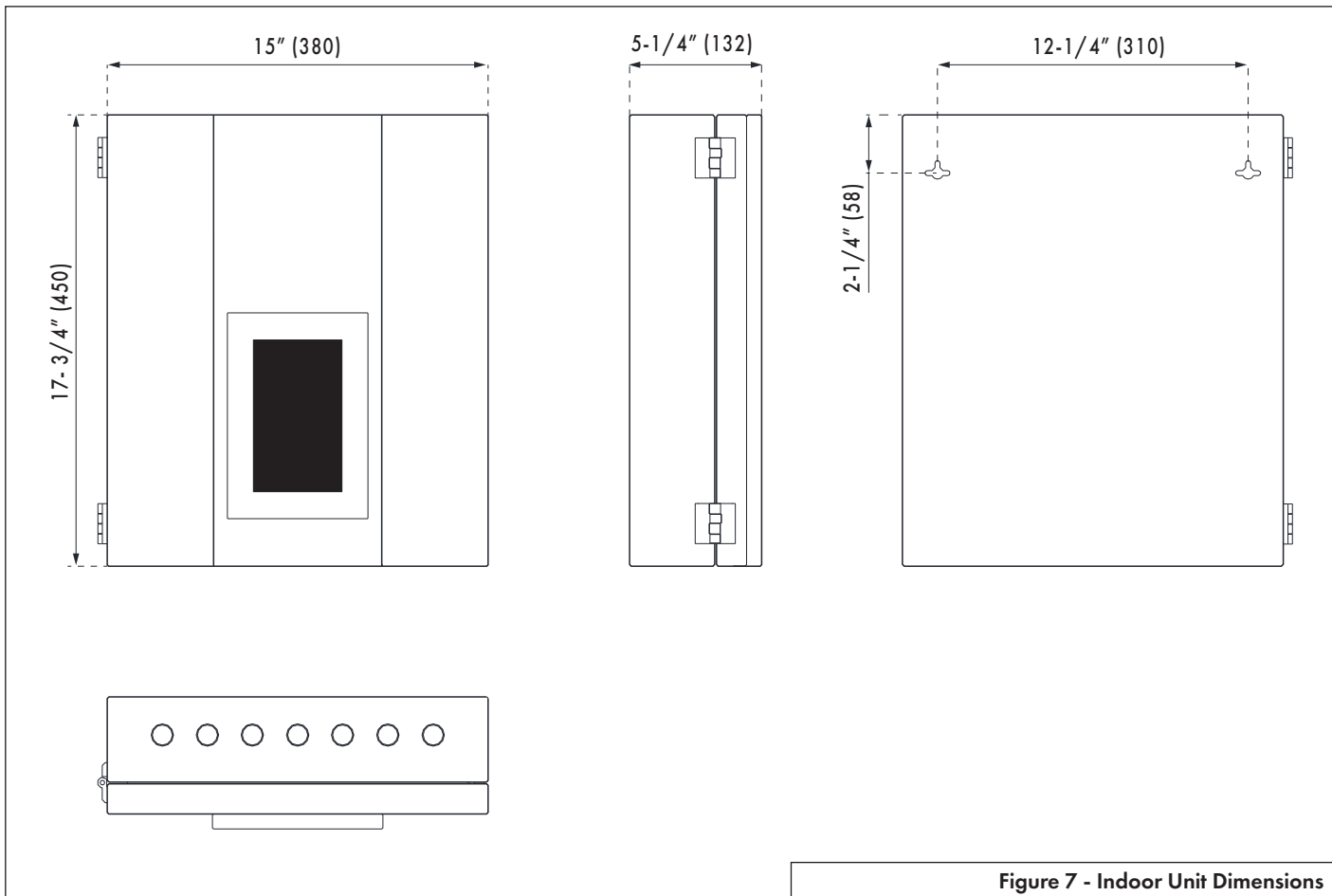

Figure 7 - Indoor Unit Dimensions

Outdoor Air to Water Heat Pump - NHP32-036

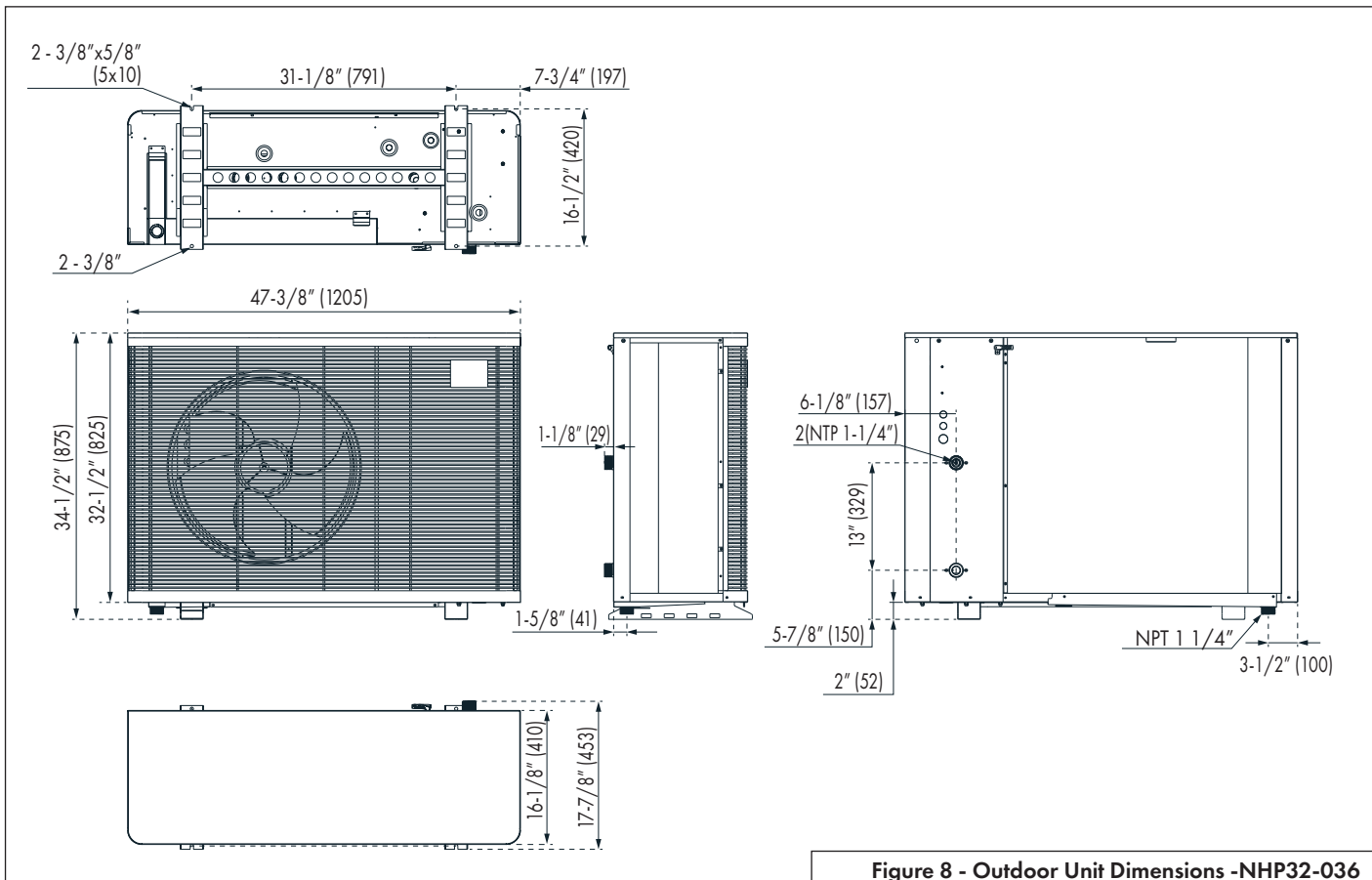

Figure 8 - Outdoor Unit Dimensions - NHP32-036

Part 3 - Prepare for Installation

Outdoor Air to Water Heat Pump NHP32-060

Unit: inches (mm)

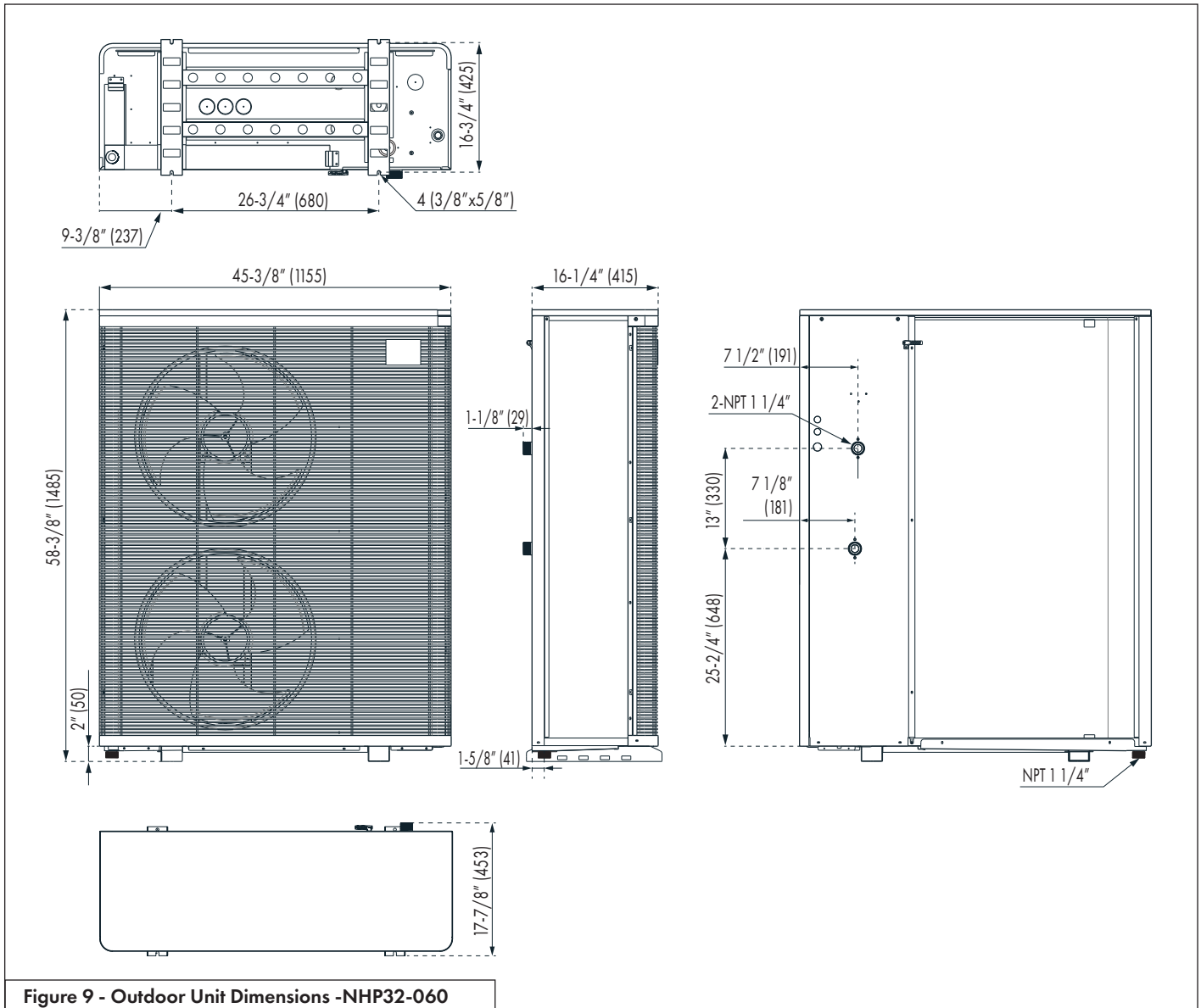

Figure 9 - Outdoor Unit Dimensions -NHP32-060

3.3 Specifications

Model			NHP32-036	NHP32-060
Cooling	Cooling Capacity RANGE (*)	BTU/hr(kW)	9,500-48,400 (2.8 - 14.2)	18,000-74,000 (5.3 - 21.7)
	Efficiency Range (*)	EER	8.15 / 22.97	7.85 / 28.8
	Efficiency (**)	IPLV	20.64	21.04
	Ambient Temp Range	DegF (DegC)	55-125 (12.8-51.7)	
	Delivered Water Temp Range	DegF (DegC)	39-49 (3.9-9.4)	
Heating	Capacity Range (*)	BTU/hr(kW)	1,600 - 42,900 (0.7 - 12.6)	3,400 - 73,500 (1 - 21.5)
	Efficiency Range (*)	COP	0.96 / 7.10	0.58 / 6.97
	Ambient Temp Range	DegF (DegC)	-13~113 (-25~45)	
	Delivered Water Temp Range	DegF (DegC)	68-140 (20-60)	
Electrical	Power	V,Ph,Hz	208/230V, 60Hz, 1Phase	
	Fan Motor	A	0.6	0.6*2
	Compressor Motor	A	14.0	28.7
	MCA	A	24.5	41
	MOPD	A	30.0	60.0
	SCCR	kA	5	5
Refrigerant	Type		R32	
	Factory Charge	lbs (kg)	3.97 (1.8)	5.73 (2.6)
	Normal Pressure Low Side	PSI	609	
	Normal Pressure High Side	PSI	174	
Fan	Quantity		1	2
	Power Input	W	90	90*2
	Type		Brushless DC motor	
	Max Speed	RPM	900	
Sound (1meter)	Range	dBa	40 - 50	44 - 54
Hydronic	Rated Flow	GPM	9.1	14.4
	Max Water Temp	DegF (DegC)	140 (60)	140 (60)
	Piping Connections	Inch	NPT 1-1/4"	
	Rated Pressure Drop	PSI (ft W.C)	3.6 (8.4)	7.66 (17.7)
Dimensions	Net Dimensions (L x W x H)	Inch (mm)	47.4 x 16.2 x 34.5 (1203 x 411 x 876)	45.5 x 16.3 x 58.3 (1155 x 415 x 1482)
	Shipping Dimensions (L x W x H)	Inch (mm)	50.2 x 17.9 x 41.5 (1275 x 455 x 1055)	48.6 x 19 x 64.4 (1235 x 482 x 1637)
	Net Weight	Lbs (kg)	211.6 (100.5)	381.4 (173)
	Shipping Weight	Lbs (kg)	255.7 (116)	418.8 (190)
Compressor	Type		Rotary	
	Speed Range	HZ	30-90	30-76
	Brand		Mitsubishi	
	Quantity		1	
Model				Indoor Control Box (Control32-7)
Electrical	Input Rating		V/HZ, kW	115V, 60Hz, 1Phase, 0.2kW
	Unit Maximum Overload Protection		A	15
Sound (1meter)			dBa	35
Dimensions	Net Dimensions (L x W x H)		Inch (cm)	17.7*15*5.2 (450*380*132)
	Shipping Dimensions (L x W x H)		Inch (cm)	19.7*16.5*8.7 (500*420*220)
	Net Weight		Lbs (kg)	21 (9.5)
	Shipping Weight		Lbs (kg)	27.6 (12.5)

Table 2 - Technical Specification Outdoor Unit - Indoor Control Box (Control32-7)

Note:
 (*) All efficiencies and capacities are reflective of the entire range of the product. For more specific data points, please refer to the graphs in this manual or to the Verta sizing tool located here <https://ntiboilers.com/product/verta-series>.
 (**) IPLV is tested and certified in accordance with AHRI 550/590.

Part 3 - Prepare for Installation

3.4 Characteristic curve

3.4.1 Curve of Heating Capacity performance

An increase in elevation will result in a decrease in temperature (i.e., a decrease in ambient temperature), and the capacity, COP correspondence point will move to the left.

Heating Capacity						
Ambient temp. (°F)	NHP 32-036					
	95 LWT°F MIN	95 LWT°F MAX	113 LWT°F MIN	113 LWT°F MAX	131 LWT°F MIN	131 LWT°F MAX
-13	1900	12900	1600	12600		
-4	2000	16600	1700	15900		
3	2200	19500	1900	18500		
5	2900	20200	2600	19100		
10	5100	22400	4600	21100	3900	18700
19	7600	26100	6700	24300	6000	22200
23	8600	28000	7500	26300	6900	23800

Heating Capacity						
Ambient temp. (°F)	NHP 32-036					
	95 LWT°F MIN	95 LWT°F MAX	113 LWT°F MIN	113 LWT°F MAX	131 LWT°F MIN	131 LWT°F MAX
32	10200	32800	8700	31400	7800	27800
34	10700	33700	9100	32400	8500	28600
36	12200	34700	10300	33500	9300	29400
41	14600	37800	12300	36400	10100	32000
45	15500	39800	13400	38400	10800	33700
50	17700	42900	15600	41400	12400	36200
54	19100	37900	17000	36500	14100	33000
57	20600	39900	18500	38500	15800	34700
59	21100	40900	18900	39400	16200	35600
68	23700	35600	21300	34300	18200	30700
77	26400	31700	23700	30600	20300	27300
86	29000	30600	26000	29500	22300	26300
95	31600	33400	28400	32200		

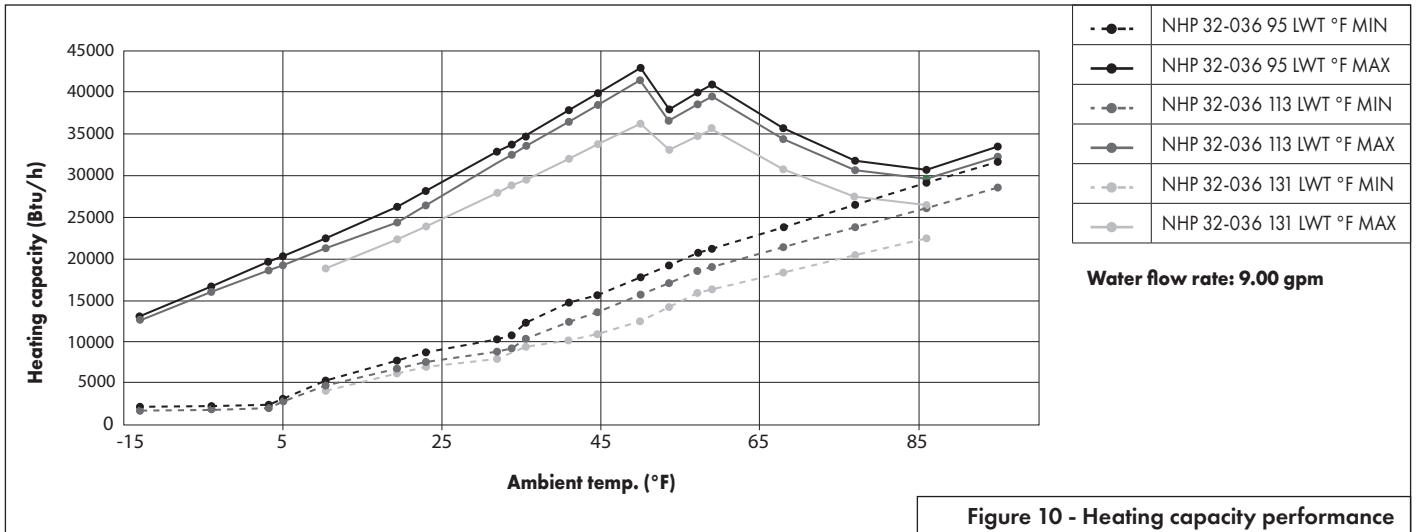

Heating Capacity						
Ambient temp. (°F)	NHP 32-060					
	95 LWT°F MIN	95 LWT°F MAX	113 LWT°F MIN	113 LWT°F MAX	131 LWT°F MIN	131 LWT°F MAX
-13	4700	21100	3400	19600		
-4	7900	27100	6700	25200		
3	10400	32000	9300	29700		
5	11100	33200	9900	30800		
10	13000	36800	11800	34200	9600	31800
19	16200	42900	15100	39800	12600	36400
23	17500	45700	16200	42900	14100	39400
32	20800	52600	19000	50500	17600	46700
34	21500	53900	19900	52000	18800	48200
36	22100	55300	20700	53600	19100	49600

Heating Capacity						
Ambient temp. (°F)	NHP 32-060					
	95 LWT°F MIN	95 LWT°F MAX	113 LWT°F MIN	113 LWT°F MAX	131 LWT°F MIN	131 LWT°F MAX
41	26500	60100	22500	58700	20200	56000
45	29400	63200	24900	62200	22500	60300
50	31900	67900	28400	67300	26000	66700
54	33500	62800	31300	59400	29500	56300
57	35200	65900	34100	62900	32900	60600
59	36000	67500	35100	64600	34100	62700
68	40200	56000	39200	54300	38100	54500
77	44400	61800	43300	60700	42000	62400
86	48600	67700	47400	67100	46000	70400
95	52800	73500	51400	73500		

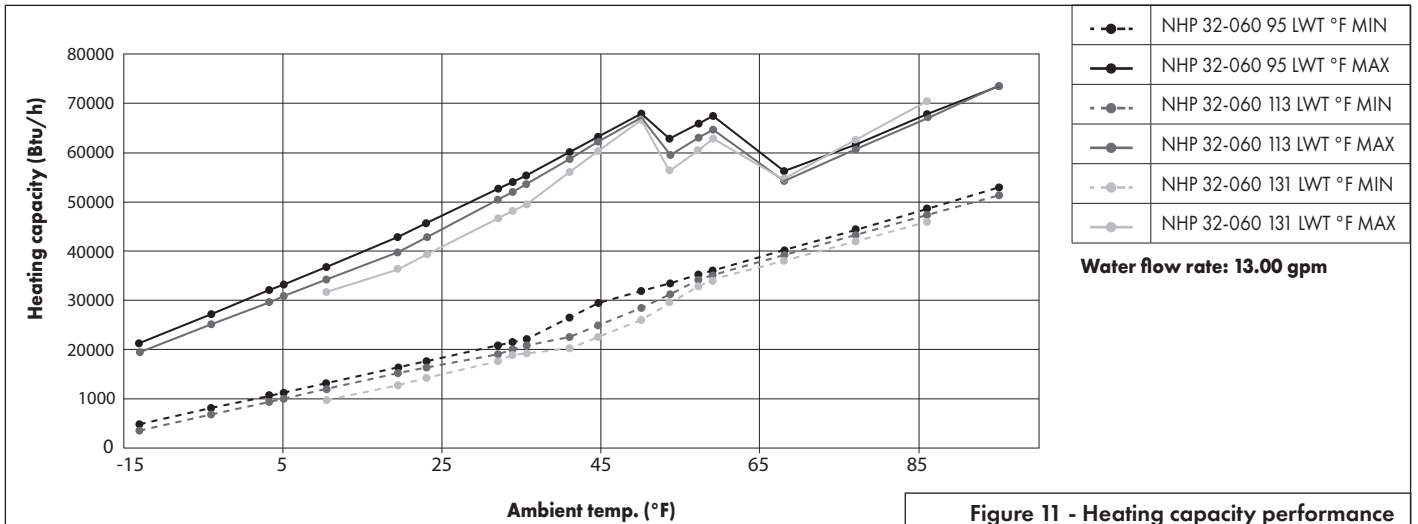

3.4.2 Curve of COP performance

An increase in elevation will result in a decrease in temperature (i.e., a decrease in ambient temperature), and the capacity, COP correspondence point will move to the left.

COP						
Ambient temp. (°F)	NHP 32-036					
	95 LWT°F MIN	95 LWT°F MAX	113 LWT°F MIN	113 LWT°F MAX	131 LWT°F MIN	131 LWT°F MAX
-13	0.98	1.69	0.96	1.39		
-4	1.01	2.09	0.98	1.68		
3	1.10	2.38	1.06	1.89		
5	1.35	2.46	1.27	1.94		
10	2.22	2.67	1.97	2.09	1.34	1.49
19	2.88	2.99	2.32	2.62	1.73	1.94
23	3.17	3.20	2.48	2.76	1.82	2.14
32	3.60	3.90	2.85	3.05	2.11	2.24

COP						
Ambient temp. (°F)	NHP 32-036					
	95 LWT°F MIN	95 LWT°F MAX	113 LWT°F MIN	113 LWT°F MAX	131 LWT°F MIN	131 LWT°F MAX
34	3.68	3.96	2.92	3.12	2.17	2.44
36	3.77	4.19	2.99	3.28	2.23	2.61
41	4.04	4.74	3.22	3.70	2.44	2.75
45	4.22	4.96	3.36	3.87	2.57	2.86
50	4.48	5.21	3.57	4.08	2.78	2.91
54	4.76	5.48	3.71	4.20	2.73	3.11
57	4.96	5.58	3.87	4.30	2.88	3.33
59	5.06	5.59	3.95	4.32	2.95	3.35
68	5.53	6.00	4.34	4.66	3.33	3.71
77	5.98	6.39	4.71	4.99	3.72	3.97
86	6.41	6.76	5.06	5.30	4.10	4.24
95	6.81	7.10	5.39	5.59		

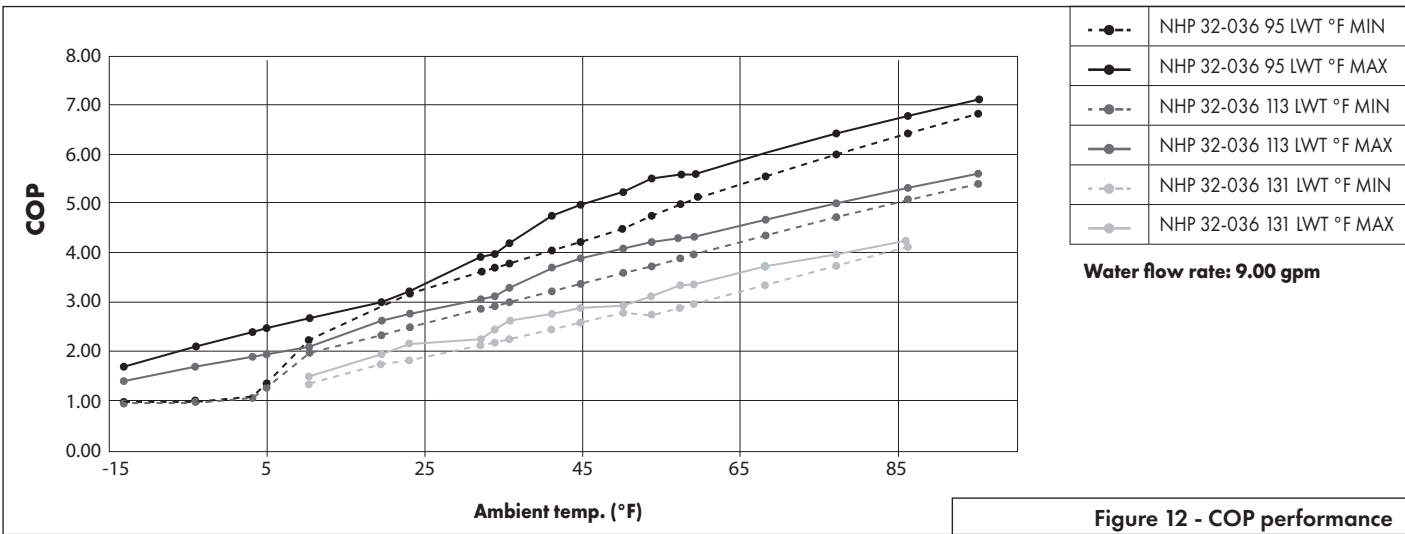

COP						
Ambient temp. (°F)	NHP 32-060					
	95 LWT°F MIN	95 LWT°F MAX	113 LWT°F MIN	113 LWT°F MAX	131 LWT°F MIN	131 LWT°F MAX
-13	0.94	1.76	0.58	1.34		
-4	1.54	2.18	1.10	1.68		
3	2.02	2.49	1.51	1.94		
5	2.13	2.56	1.61	2.00		
10	2.47	2.78	1.90	2.19	1.36	1.74
19	3.03	3.12	2.38	2.49	1.75	1.93
23	3.27	3.31	2.54	2.65	1.94	2.04
32	3.80	3.88	2.93	3.03	2.32	2.33
34	3.90	4.08	3.04	3.11	2.37	2.45
36	3.99	4.12	3.10	3.18	2.42	2.48

COP						
Ambient temp. (°F)	NHP 32-060					
	95 LWT°F MIN	95 LWT°F MAX	113 LWT°F MIN	113 LWT°F MAX	131 LWT°F MIN	131 LWT°F MAX
41	4.23	4.74	3.35	3.43	2.60	2.73
45	4.38	5.16	3.58	3.63	2.75	2.93
50	4.60	5.35	3.82	4.13	3.12	3.22
54	5.18	5.64	4.03	4.48	3.13	3.45
57	5.34	5.85	4.20	4.63	3.36	3.65
59	5.41	5.90	4.29	4.70	3.47	3.68
68	5.79	6.22	4.70	5.06	4.03	4.05
77	6.13	6.50	5.09	5.38	4.36	4.59
86	6.44	6.74	5.46	5.68	4.59	5.13
95	6.73	6.97	5.80	5.96		

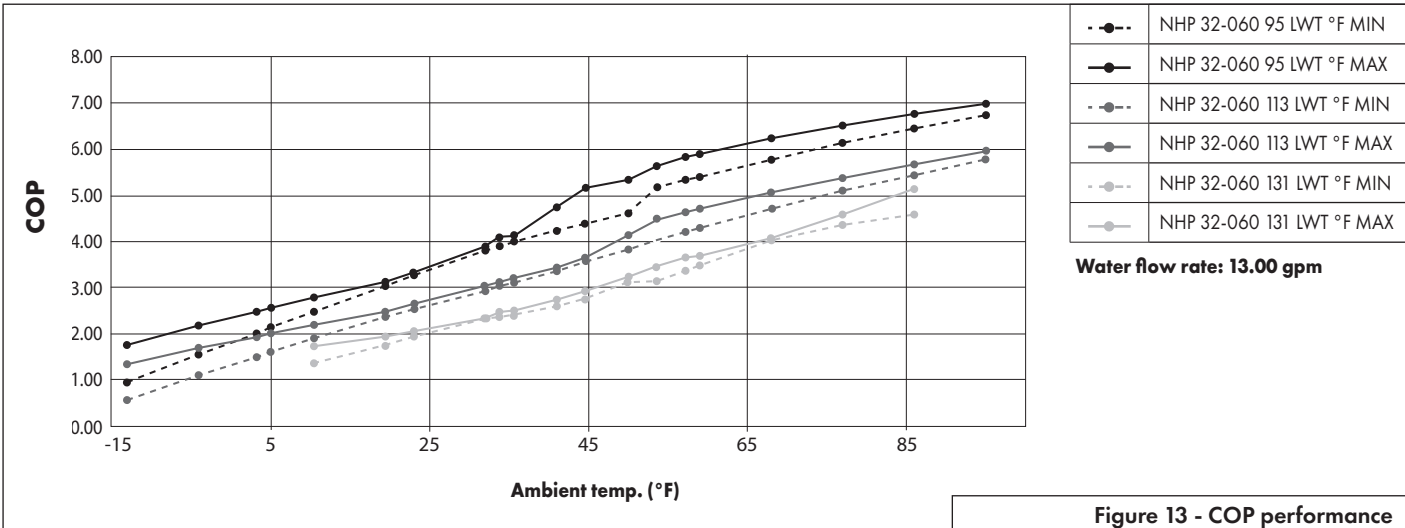

Part 3 - Prepare for Installation

3.4.3 Curve Cooling Capacity Performance

An increase in elevation will result in a decrease in temperature (i.e., a decrease in ambient temperature), and the capacity, COP correspondence point will move to the left.

Water flow rate: 9.00 gpm

Ambient temp. (°F)	Cooling Capacity			
	NHP 32-036			
	45 LWT°F MIN	45 LWT°F MAX	64 LWT°F MIN	64 LWT°F MAX
61	15100	21200	21800	30500
70	14500	27200	17900	33400
79	12900	33600	18600	48400
90	11600	30200	16700	43500
100	10300	26800	14800	38500
109	9500	19400	11700	23900

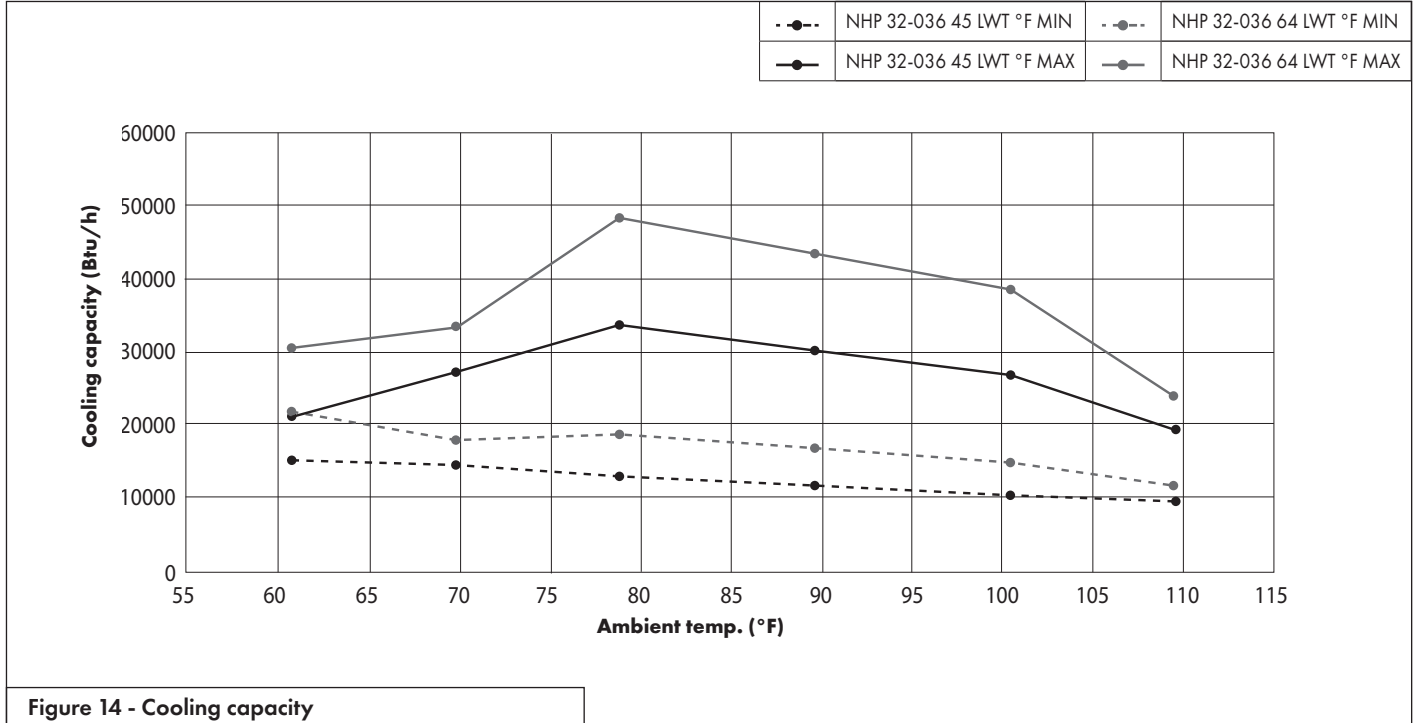

Figure 14 - Cooling capacity

Ambient temp. (°F)	Cooling Capacity			
	NHP 32-060			
	45 LWT°F MIN	45 LWT°F MAX	64 LWT°F MIN	64 LWT°F MAX
61	27300	47400	39300	68000
70	25500	51800	36300	73800
79	23800	52400	33600	74000
90	22400	56600	29900	75800
100	20200	51200	27100	68500
109	17900	36300	25400	51700

Water flow rate: 13.00 gpm

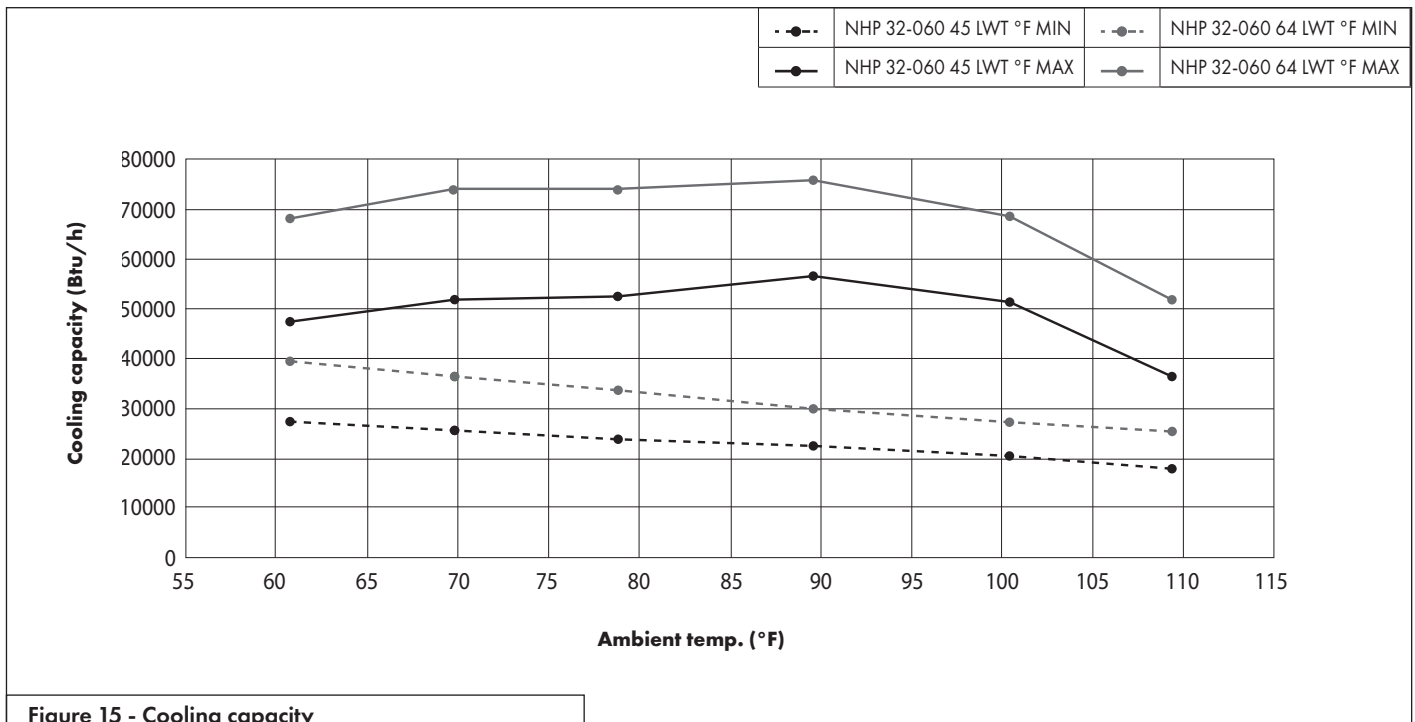

Figure 15 - Cooling capacity

3.4.4 Curve of EER Performance

An increase in elevation will result in a decrease in temperature (i.e., a decrease in ambient temperature), and the capacity, COP correspondence point will move to the left.

Water flow rate: 9.00 gpm

Ambient temp. (°F)	EER			
	NHP 32-036			
	45 LWT°F MIN	45 LWT°F MAX	64 LWT°F MIN	64 LWT°F MAX
61	19.18	23.86	23.59	29.77
70	14.71	18.84	22.24	24.20
79	11.33	14.01	16.16	18.07
90	9.28	11.24	12.97	14.50
100	8.33	9.01	10.39	11.62
109	8.19	8.62	9.82	10.98

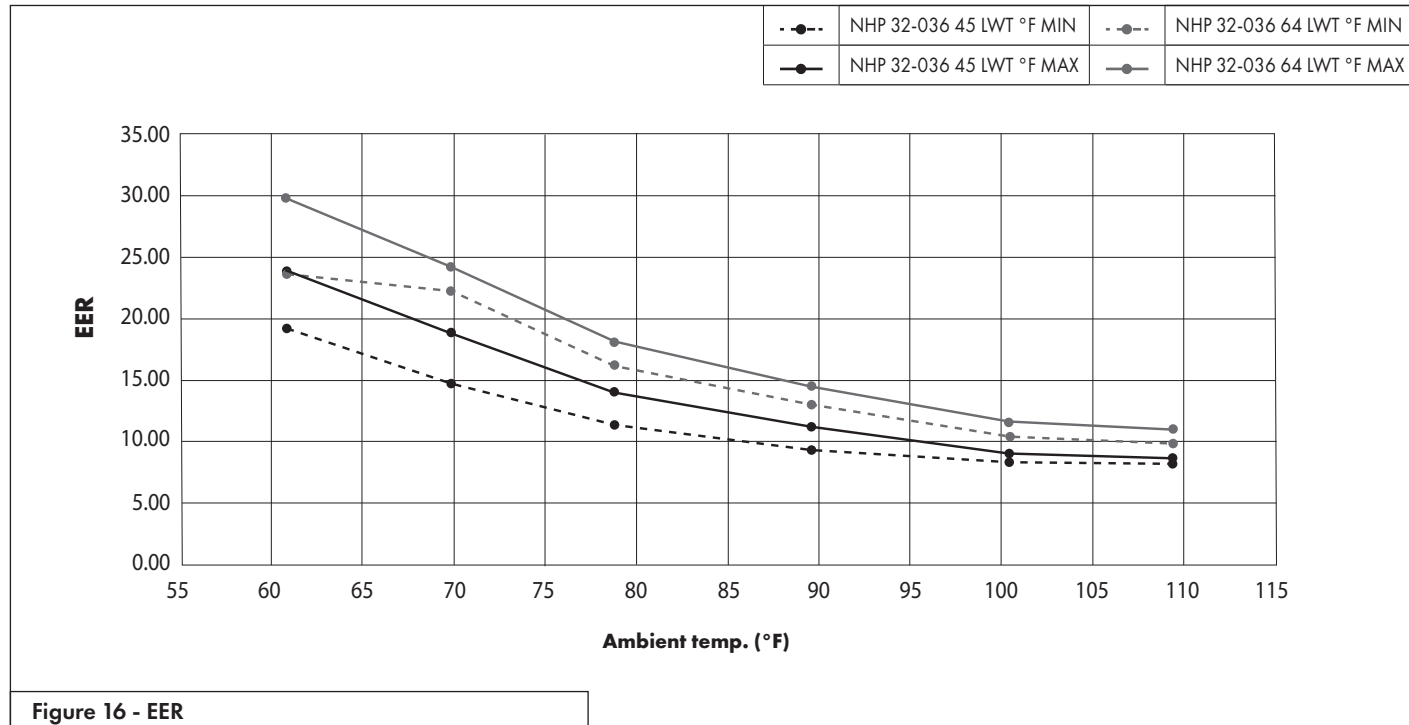

Figure 16 - EER

Ambient temp. (°F)	EER			
	NHP 32-060			
	45 LWT°F MIN	45 LWT°F MAX	64 LWT°F MIN	64 LWT°F MAX
61	22.52	25.02	30.00	33.33
70	17.25	19.16	22.76	25.29
79	14.03	15.59	18.36	20.40
90	11.01	12.24	13.70	15.22
100	8.94	9.93	11.11	12.35
109	7.90	8.77	10.42	11.58

Water flow rate: 13.00 gpm

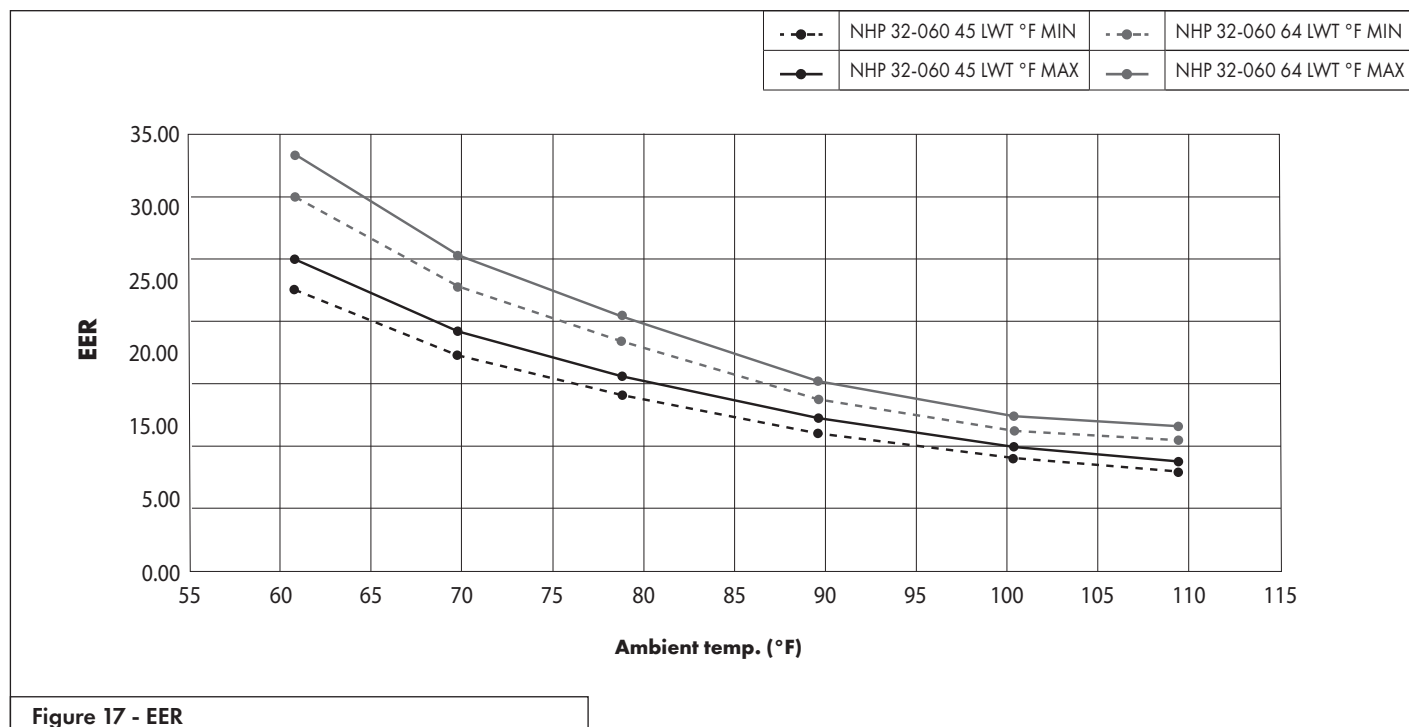
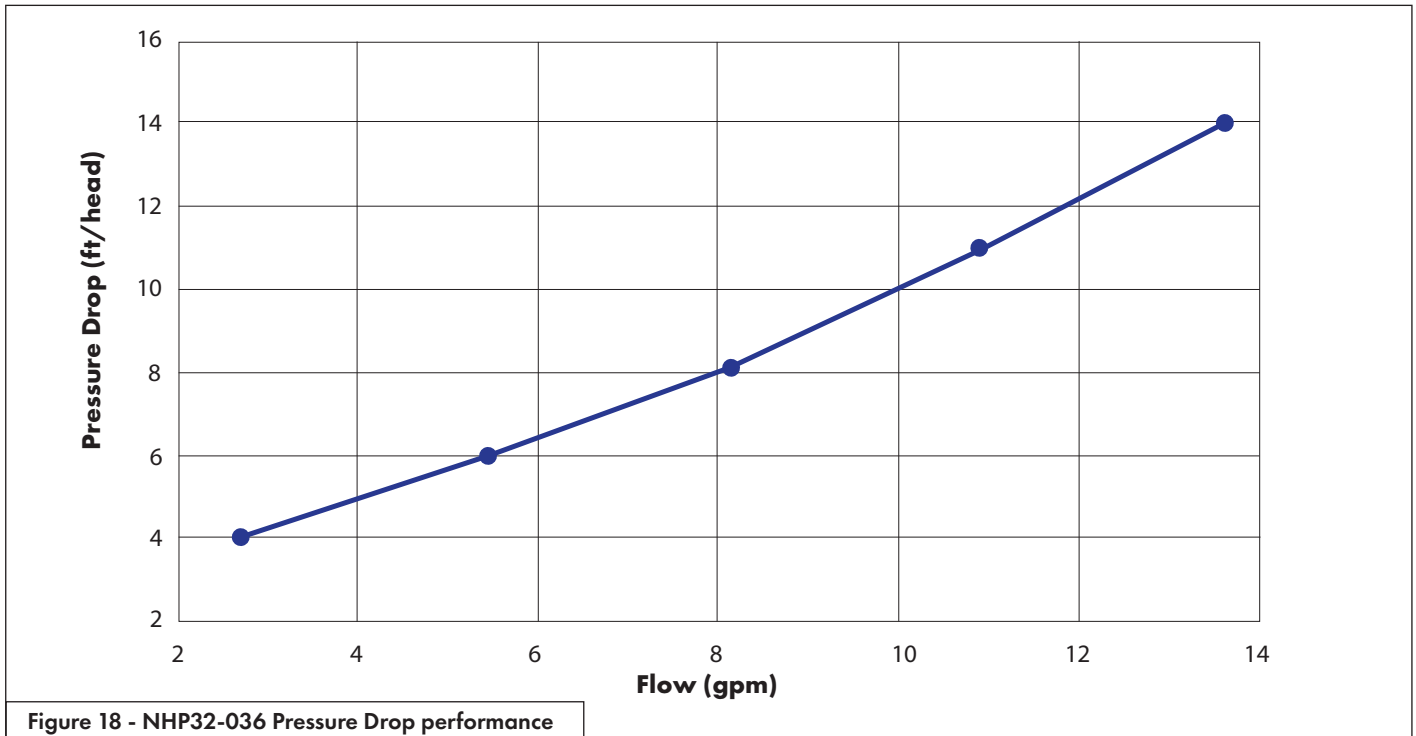

Figure 17 - EER

Part 3 - Prepare for Installation

3.4.5 Flow rate and pressure drop

NHP32-036 - Curve of Pressure Drop performance



NHP32-060 - Curve of Pressure Drop performance

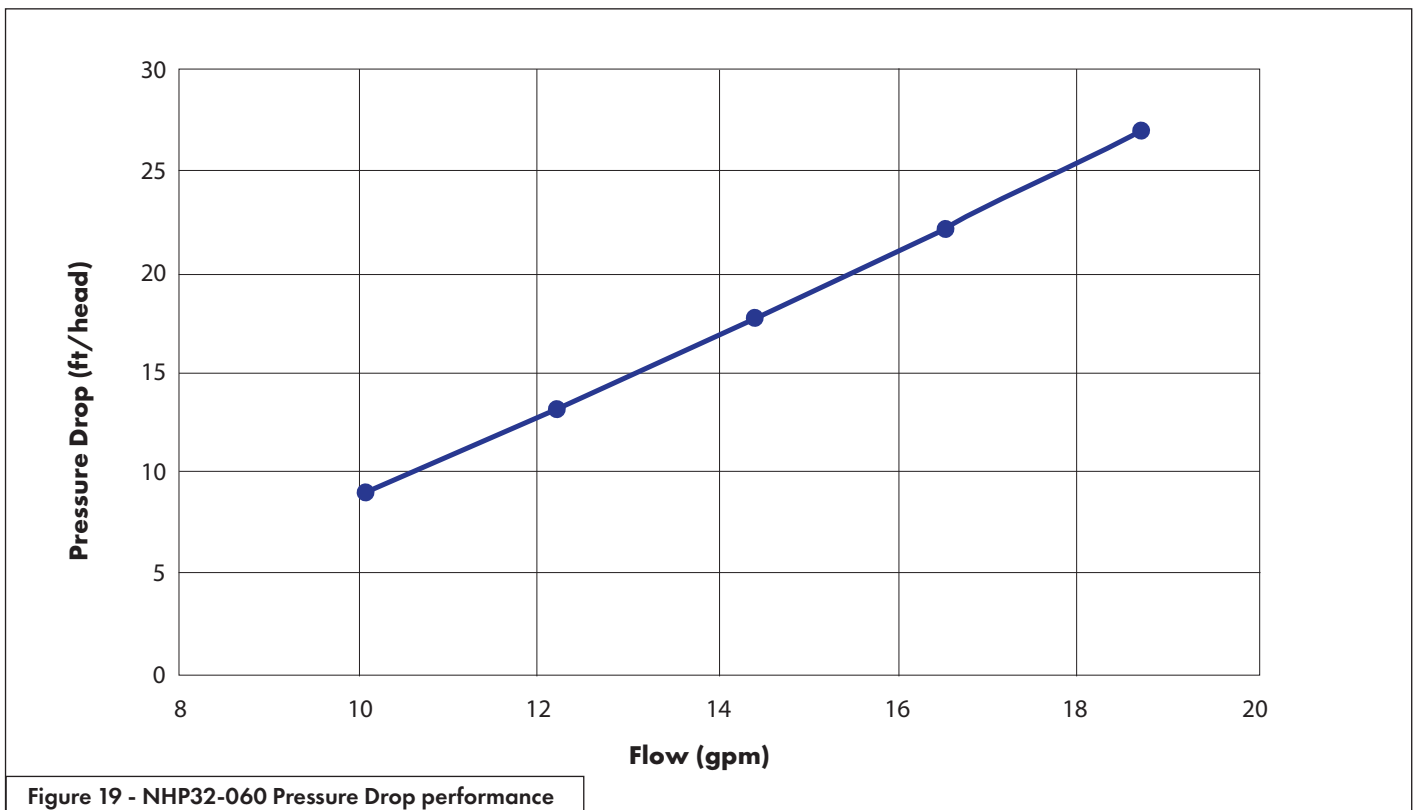

3.4.6 Heating and Cooling operating range

Heating mode operation range

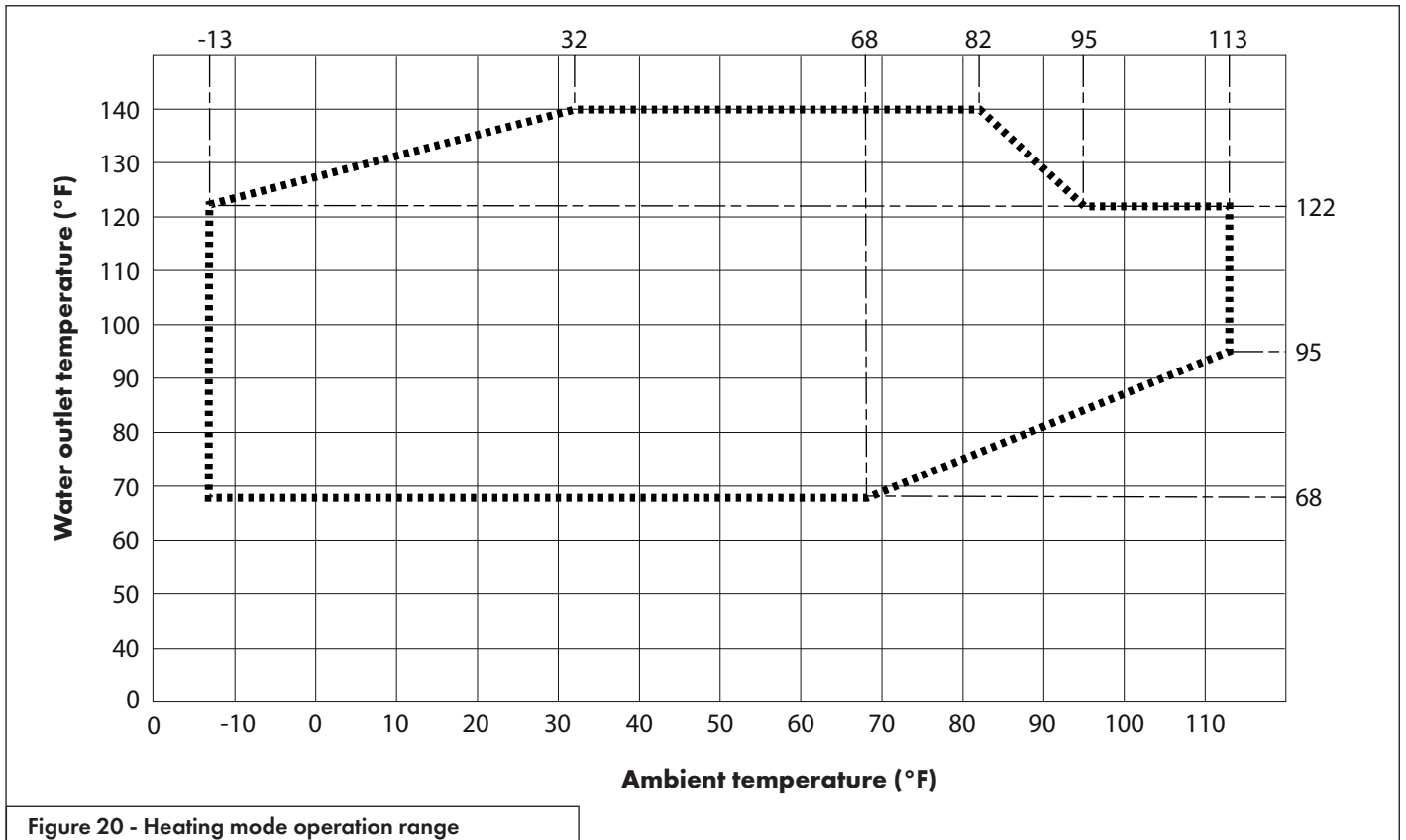

Cooling mode operation range

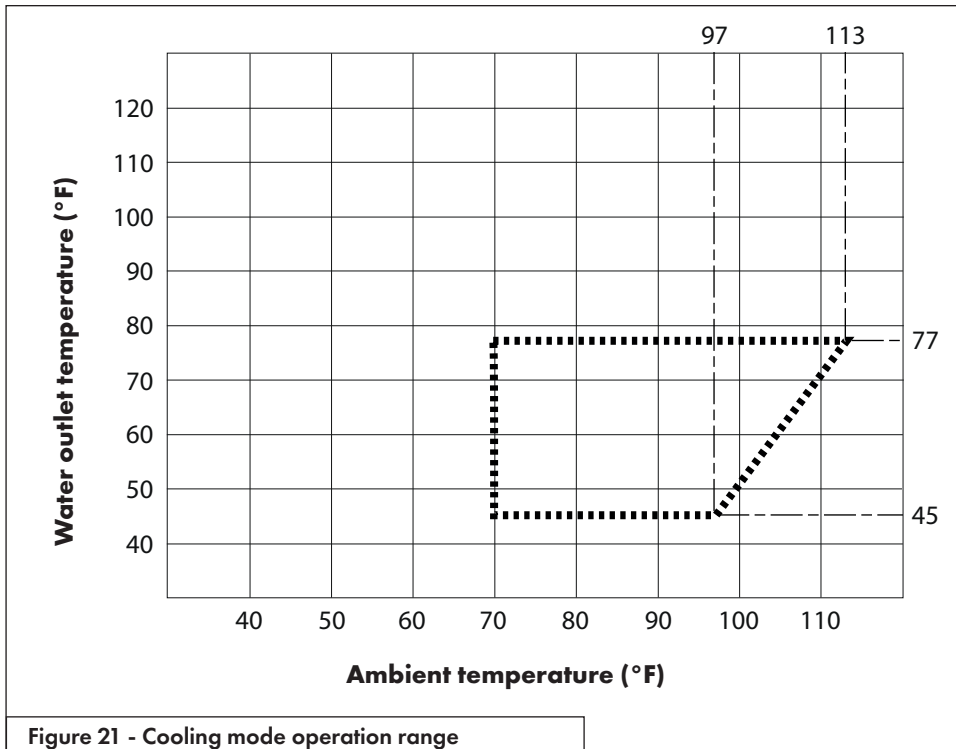

Part 4 - Installation

4.1 Preliminary Information

This manual is intended to provide detailed instructions for the successful installation of your newly purchased heat pump product. Please ensure that this manual, along with the User's and Service manuals, are kept in an easy-to-access location for your reference later on.

DISCLAIMER

Proper adherence to the directions provided herein is vital for both the smooth operation of this system, as well as for your safety and the safety of those around you.

NTI Boilers Inc. is not responsible or liable for any losses incurred due to misuse or mishandling of this product, which includes, but is not limited to:

- Purchasing, installing, and/or operating this product with the intention of using it outside of its established, technical purpose.
- Carrying out improper work upon the unit, or any of its components, that has not been given explicit, prior consent in the form of writing.
- Installation attempts of this system by anyone other than a properly trained and licensed professional.
- Negligence of properly-worn personal protection (safety glasses, gloves, etc.) while performing installation, maintenance, or servicing of this product.
- The operation of this system during ambient temperatures which are below or beyond the temperature range intended (- 13°F to 109°F).

SAFETY

If unsure of what installation procedures to use, please contact your local distributor for information and/or advisement.

Any accessories used with this product must be official only.

Any electrical work must be carried out by certified electricians only. The manufacturer is not responsible for any alterations or modifications that are made without explicit, written approval.

The design of this unit complies and conforms to all necessary and relevant safety regulations, and is otherwise safe to operate for its intended use.

Please pay attention to the following pages, which detail important precautions that should be closely followed, to ensure safe installation and operation.

4.2 Applications

CAUTION

In mixed temperature applications, a mixing valve is required for the protection of low temperature loops.

Legend













Symbol	Description
	Ball valve
	Circulator generic
	By-pass valve
	Magnetic filter
	Discharge
	Polyphosphate feeder
	Safety valve
	Syphon
	Non return valve
	Shut-off valve
	Thermostatic mixing valve
	Balancing valve

Table 3 - Piping Symbol Legend

1. Central Heating/Cooling with Buffer Tank

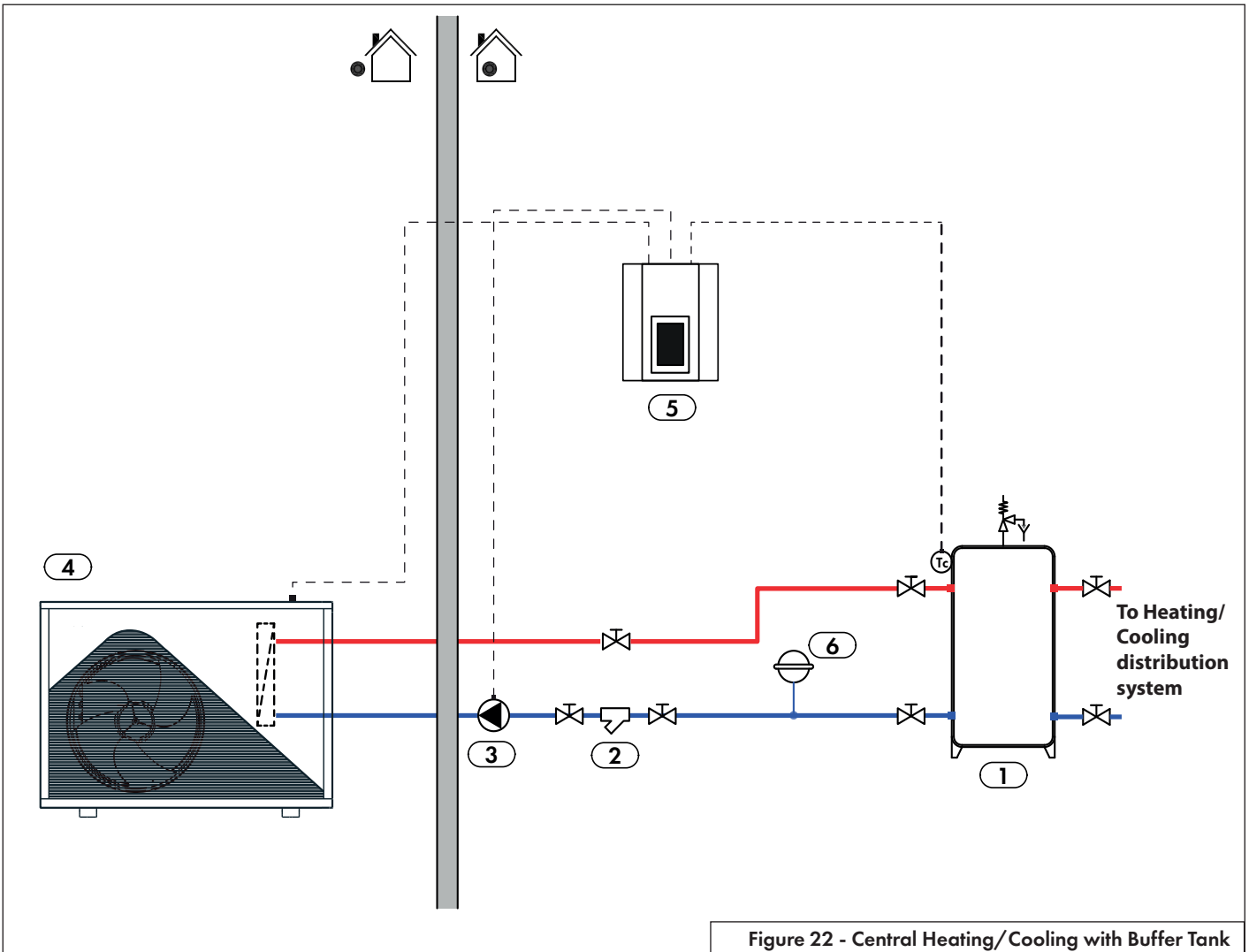

Figure 22 - Central Heating/Cooling with Buffer Tank

Item	Name
1	4 Port buffer tank
2	Filter
3	Circulation pump (PO)

Item	Name
4	Outdoor unit (NHP32-036)
5	Indoor Control Box
6	CH Expansion tank

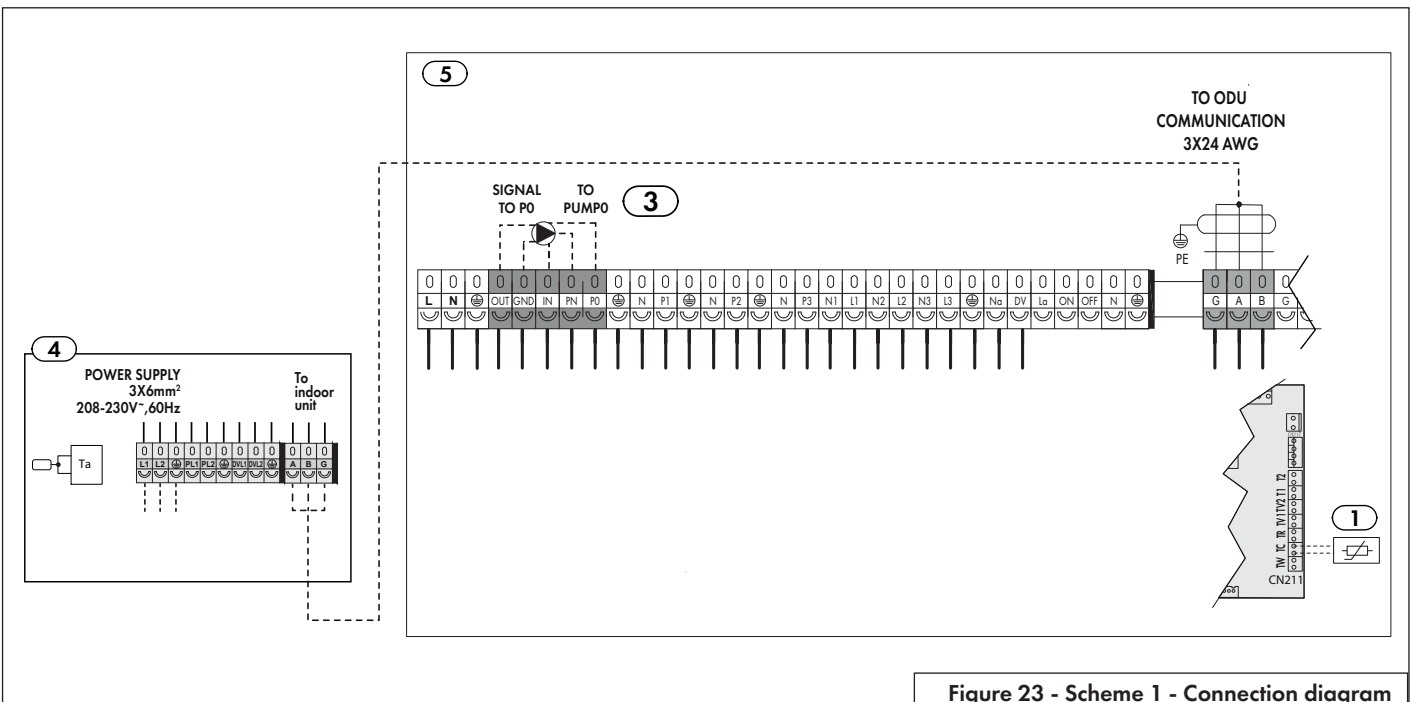

Figure 23 - Scheme 1 - Connection diagram

Part 4 - Installation

2. Central Heating-Cooling Hybrid

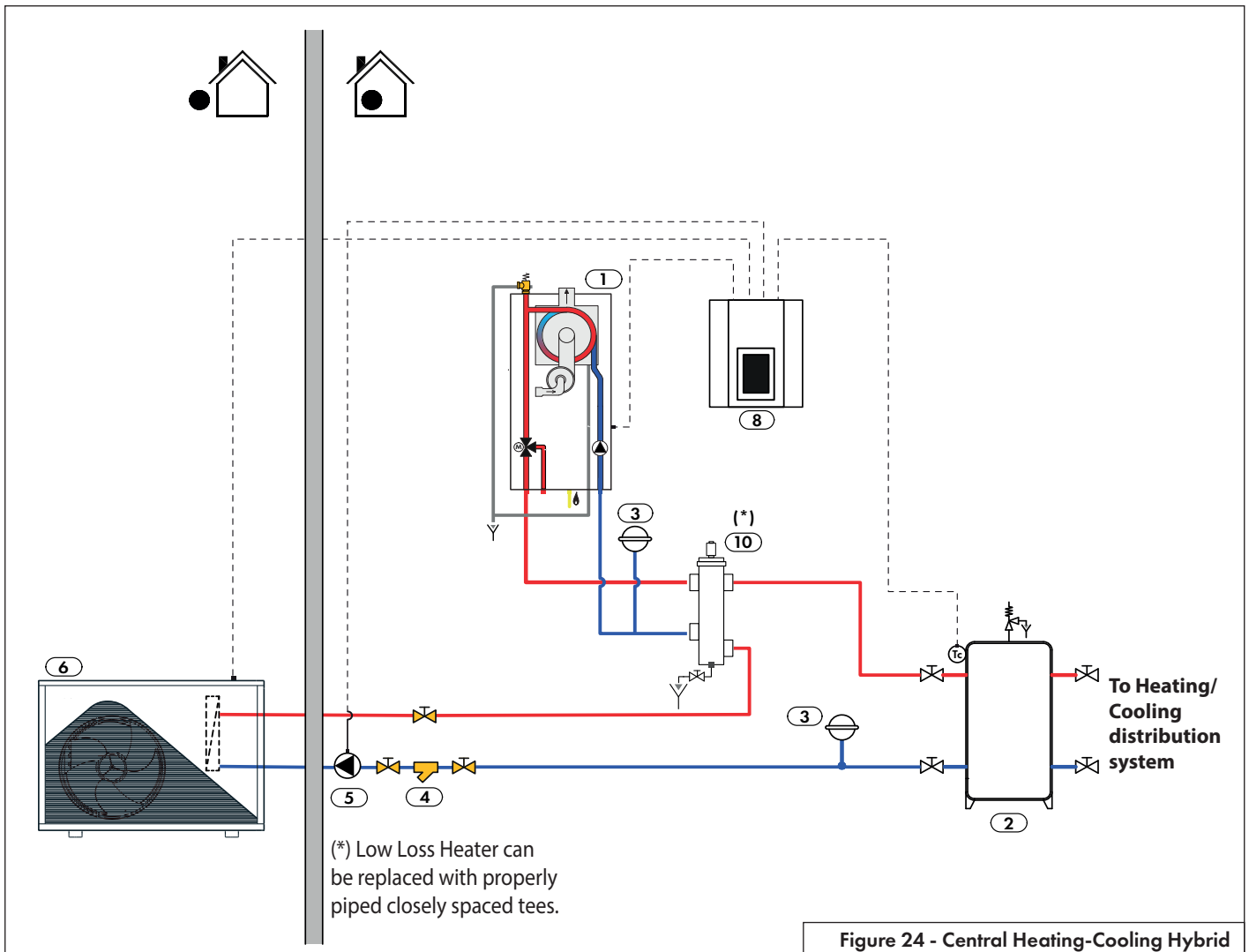

Figure 24 - Central Heating-Cooling Hybrid

Item	Name
1	NTI BOILER
2	4 Port buffer tank
3	CH Expansion tank
4	Filter
5	Circulation pump (PO)

Item	Name
6	Outdoor unit (NHP32-036)
8	Indoor Control Box
9	RELAY Single Pole Single Throw (SPST)
10	Low Loss header

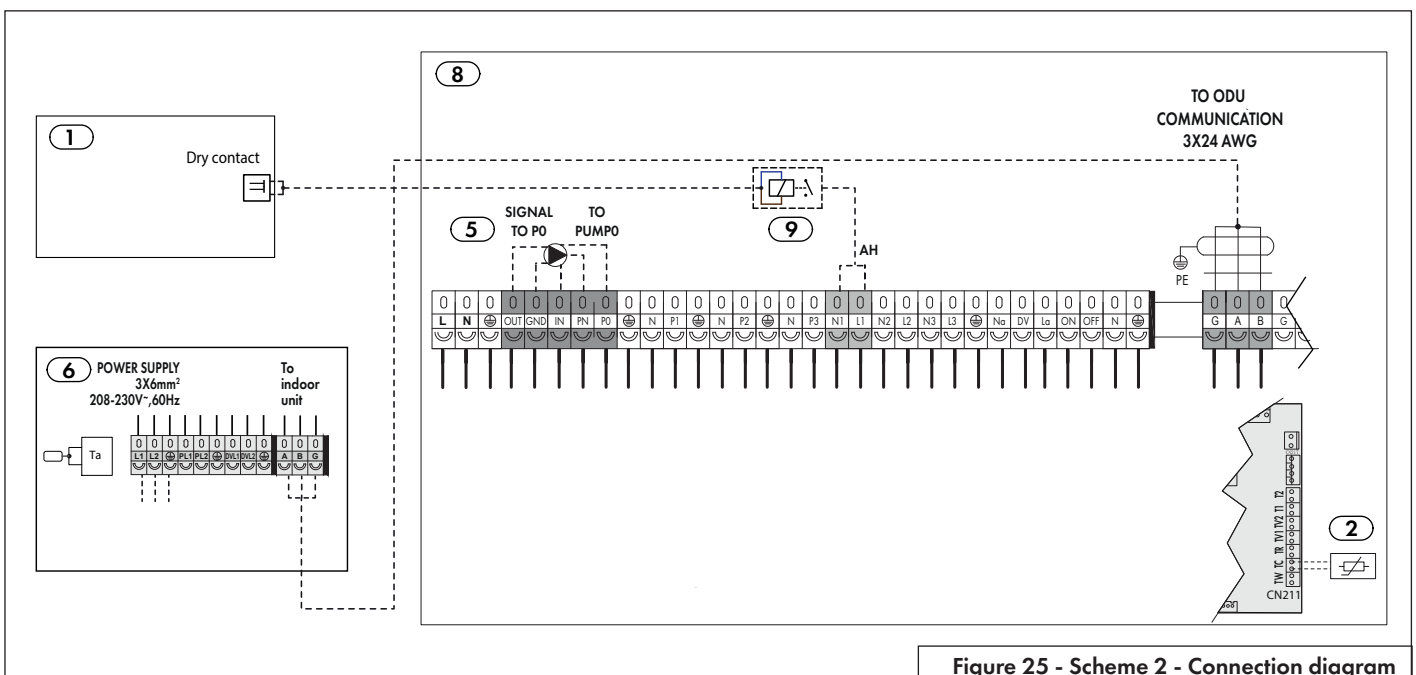



Figure 25 - Scheme 2 - Connection diagram

MENU		PARAMETER	VALUE TO BE SET	RANGE	DEFAULT
 <p>Heating/Cooling Circuit 1</p>	1.01	Heating/Cooling Stops based on Water ΔT	$\Delta T = 4^{\circ}F$	[2-9]	4 $^{\circ}F$
		Set ΔT to stop (1.01). Unit stops running when [Tset+ ΔT] in heating operation or when [Tset- ΔT] in cooling operation.			
	1.02	Heating /Cooling Restarts based on Water ΔT	$\Delta T = 4^{\circ}F$	[2-9]	4 $^{\circ}F$
		Set ΔT to restart (1.02). Unit restarts running when [Tset- ΔT] in heating operation or when [Tset+ ΔT] in cooling operation.			
	1.03	ΔT Compressor Speed-Reduction	9 $^{\circ}F$	[2-18]	4 $^{\circ}F$
		This parameter is used to set a temperature that compressor starts to slow down its speed.			
	1.04	Set temp. for heating (fix flow water temperature)	113 $^{\circ}F$	[68 - par. 1.12]	104 $^{\circ}F$
		Fixed water setpoint for heating operation to be set in Water Temperature Control Mode (refer to par. 4.05) and heating curve function is off.			
	1.05	Set temp. for cooling (fix flow water temperature)	50 $^{\circ}F$	[par. 1.11 - 77]	50 $^{\circ}F$
		Fixed water setpoint for cooling operation to be set in Water Temperature Control Mode (refer to par. 4.05) and cooling curve function is off.			
	1.09	Ideal room temp. in heating	up to user	[54-95]	73 $^{\circ}F$
		Set an ideal room temperature in heating (1.09) in Room Temperature Control mode (refer to par. 4.05)			
1.10	Ideal room temp. in cooling	up to user	[59-95]	97 $^{\circ}F$	
	Set an ideal room temperature in cooling (1.10) in Room Temperature Control mode (refer to par. 4.05)				
1.11	Low temperature limit 1	41 $^{\circ}F$	[41-77]	45 $^{\circ}F$	
	Min safety value of the set temperature for circuit 1 for cooling operation.				
1.12	High temperature limit 1	131 $^{\circ}F$ (not possible to set more than 131 $^{\circ}F$)	[68-140]	131 $^{\circ}F$	
	Max safety value of the set temperature for circuit 1 for heating operation.				
 <p>Working Mode</p>	4.01	Number of outdoor unit	Up to user		1
		Set the number of outdoor unit			
	4.02	Hot water mode	Up to user	Blue = ON Grey= OFF	ON
		Set whether the system has sanitary hot water circuit or not			
	4.03	Heating	Up to user	Blue = ON Grey= OFF	ON
		Set whether the system has water circuit for house heating or not			
	4.04	Cooling	Up to user	Blue = ON Grey= OFF	OFF
		Set whether the system has water circuit for house cooling or not			
	4.05	Basic Operation Mode	Up to user	Blue = ON Grey= OFF	OFF
		Set the basic operation mode, as "Water Temperature Control" (by default) or "Room Temperature Control"			
	4.08	Heating ECO Operation	Up to user	Blue = ON Grey= OFF	OFF
		Activate or deactivate the Heating ECO Operation			
4.09	Ambient temp. to start heating ECO operation	Up to user	[-4 - 109]	14 $^{\circ}F$	
	If ambient temp. is lower than this value,compressor will stop.				

Part 4 - Installation





MENU		PARAMETER	VALUE TO BE SET	RANGE	DEFAULT
 Parameters Overview	11.02 (page 2/2)	Setting button	To be set as Menu Working Mode: - Hot Water mode: set as 4.02 - Heating mode: set as 4.03 - Cooling: set as 4.04	Blue = ON Grey= OFF	
		Device Configuration: - Hot Water mode: Set whether the system has sanitary hot water circuit or not (refer to 4.02) - Heating mode: Set whether the system has water circuit for house heating or not (refer to 4.03) - Cooling: Set whether the system has water circuit for house cooling or not (refer to 4.04)			
 Water Pump Settings	12.01	Circulation pump P0 type	Up to user	[AC Pump - PWM Pump]	PWM Pump
		Set the type of circulation pump inside the unit (P0). It is set by installer level.			
	12.02	Working mode of circulation pump P0	Up to user	[1-3]	1 - Interval working mode
		To set the working mode of circulation pump for cooling/heating.			
	12.03	Pump Off interval for P0	5 min	[5-60]	6 min
		If par 13.02 is set to "Interval Working Mode", P0 stops after compressor stops for this time interval			
12.04	Pump On time for P0	1 min	[1-10]	1 min	
	If par 13.02 is set to "Interval Working Mode", after compressor stops P0 will run for "ON interval" time after every "OFF interval" minute stops.				
12.05	Buffer tank	ON	Blue = ON Grey= OFF	ON	
	If the system has a buffer tank = ON.				
 Electrical & back-up heater settings	13.01	Heating Back-up Heater (HBH)	OFF	Blue = ON Grey= OFF	OFF
		Set whether the system has HBH(Heating Backup Heater)			
	13.04	Hot Water Back-up Heater (HWTBH)	OFF	Blue = ON Grey= OFF	OFF
		Set whether the system has HWTBH(Hot Water Tank Back-up Heater).			
	13.07	Emergency operation	ON	Blue = ON Grey= OFF	OFF
When heat pump failed to work, whether the unit should turn ON the back-up heating system automatically.					
13.08	Disactivated auxiliary heater (AH)	OFF	Blue = ON Grey= OFF	OFF	
	This function sets whether auxiliary heater is disactivated				
 Other Settings	14.01	Motorized diverting valve switching time: * WATSS ** LK Armature	* 6 min ** 1 min	[0-10]	6 min
		Set the switching time of the motorized diverting valve spending on switching the water flow fully between DHW and Heating/Cooling circuit.			
	14.02	Diverting valve-power on time	0 - Always with Power	[0-16]	0 - Always with Power
Set how long the motorized diverting valve should be powered, for switching the water flow fully between DHW and Heating/Cooling circuit.					

Table 4 - Parameters Setting (Scheme 1 and 2)

3. Central Heating-Cooling with DHW Indirect

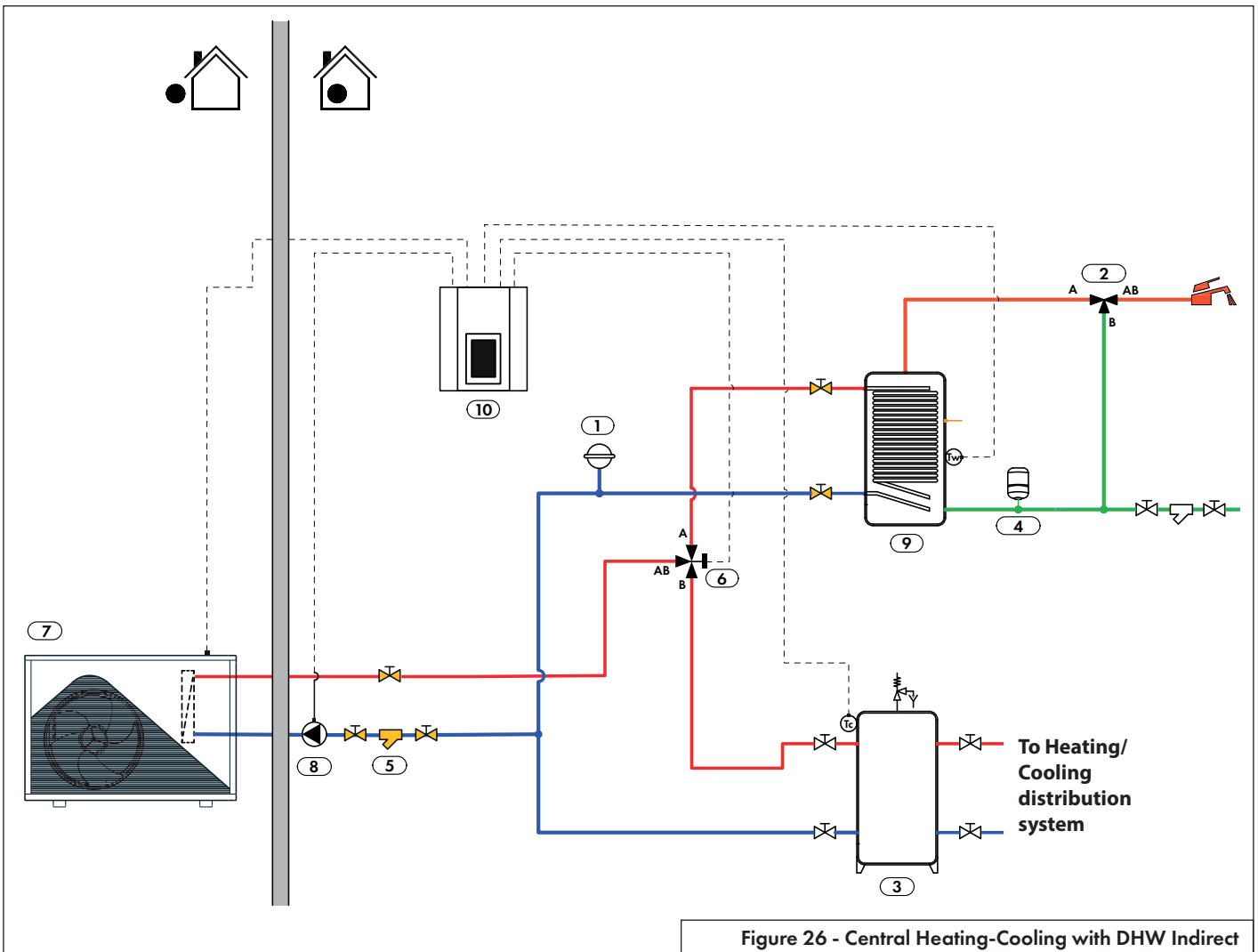

Figure 26 - Central Heating-Cooling with DHW Indirect

Item	Name
1	CH Expansion tank
2	Thermostatic mixing valve
3	4 Port buffer tank
4	DHW Expansion tank
5	Filter

Item	Name
6	HEATING-DHW 3-way valve
7	Outdoor unit (NHP32-036)
8	Circulation pump (P0)
9	HP Indirect tank
10	Indoor Control Box

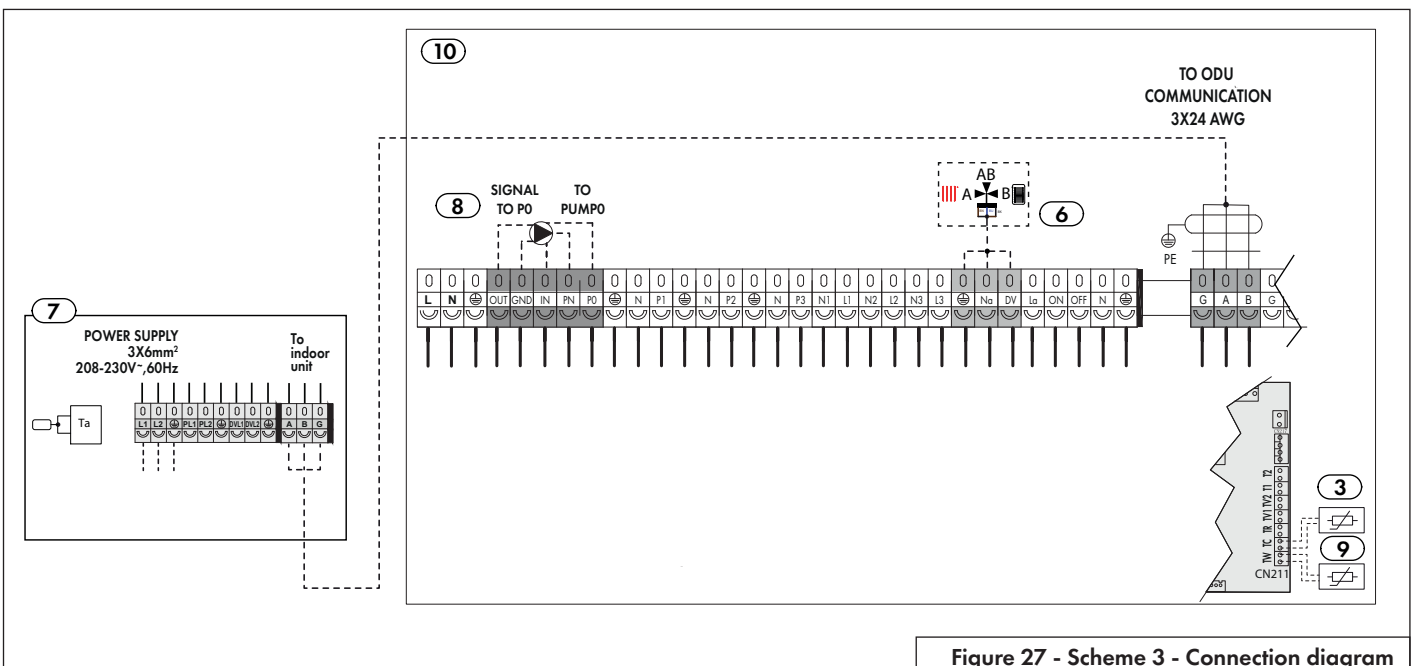









Figure 27 - Scheme 3 - Connection diagram

MENU		PARAMETER	VALUE TO BE SET	RANGE	DEFAULT	
 <p>Heating/Cooling Circuit 1</p>	1.01	Heating/Cooling Stops based on Water ΔT Set ΔT to stop (1.01). Unit stops running when [Tset+ ΔT] in heating operation or when [Tset- ΔT] in cooling operation.	$\Delta T = 4^{\circ}F$	[2-9]	4 $^{\circ}F$	
	1.02	Heating /Cooling Restarts based on Water ΔT Set ΔT to restart (1.02). Unit restarts running when [Tset- ΔT] in heating operation or when [Tset+ ΔT] in cooling operation.	$\Delta T = 4^{\circ}F$	[2-9]	4 $^{\circ}F$	
	1.03	ΔT Compressor Speed-Reduction Compressor starts to slow down its speed when [Tset- ΔT]	9 $^{\circ}F$	[2-18]	4 $^{\circ}F$	
	1.04	Set temp. for heating (fix flow water temperature) Fixed water setpoint for heating operation to be set in Water Temperature Control Mode (refer to par. 4.05) and heating curve function is off.	113 $^{\circ}F$	[68 - par. 1.12]	104 $^{\circ}F$	
	1.05	Set temp. for cooling (fix flow water temperature) Fixed water setpoint for cooling operation to be set in Water Temperature Control Mode (refer to par. 4.05) and cooling curve function is off.	50 $^{\circ}F$	[par. 1.11 - 77]	50 $^{\circ}F$	
	1.09	Ideal room temp. in heating Set an ideal room temperature in heating (1.09) in Room Temperature Control mode (refer to par. 4.05)	up to user	[54-95]	73 $^{\circ}F$	
	1.10	Ideal room temp. in cooling Set an ideal room temperature in cooling (1.10) in Room Temperature Control mode (refer to par. 4.05)	up to user	[59-97]	97 $^{\circ}F$	
	1.11	Low temperature limit 1 Min safety value of the set temperature for circuit 1 for cooling operation.	41 $^{\circ}F$	[41-77]	45 $^{\circ}F$	
	1.12	High temperature limit 1 Max safety value of the set temperature for circuit 1 for heating operation.	131 $^{\circ}F$	[68-131]	131 $^{\circ}F$	
	 <p>Sanitary hot water</p>	3.01	Setpoint DHW Set temperature for sanitary hot water	113 $^{\circ}F$	[68- par. 3.09]	140 $^{\circ}F$
		3.02	DHW restart ΔT setting Heat pump unit will restart to work for sanitary hot water, after temperature drops below Tset- ΔT here	9 $^{\circ}F$	[4-41]	41 $^{\circ}F$
3.03		Heating/DHW shifting priority Turn ON/OFF Shifting Priority Function. For more clarity on this function, please see installation manual "Part 5 - Controls"	OFF	Blue = ON Grey= OFF	OFF	
3.04		Ambient temp. to start shifting priority mode Only if 3.03 = ON. Set the ambient temperature below which Shifting Priority Function starts to work.	up to user	[5 - 68]	34 $^{\circ}F$	
3.05		Min. working time for DHW(minutes) Only if 3.03 = ON. Set the minimum working period of sanitary hot water mode	20 min	[10-60]	20 min	
3.06		Max.working time for heating (minutes) Only if 3.03 = ON If system switches from sanotary hot water to heating, this value sets the maximum working period of the heating mode.	30 min	[30-180]	30 min	
3.07		Allowable temp drift in heating Only if 3.03 = ON. Whether heating temp. drop is over "Allowable temp drift min heating", system switches from DWH to heating.	9 $^{\circ}F$	[5-18]	9 $^{\circ}F$	
3.08		DHW backup heater for shifting priority Only if 3.03 = ON. If it is set ON, even if heat pump switch to heating mode, HWTBH (refer to 15.04) will remain active to support sanitary mhot water.	OFF	Blue = ON Grey= OFF	OFF	
3.09		High temperature limit (DHW) Max safety value of the set temp for DHW operation	131 $^{\circ}F$	[68-140]	140 $^{\circ}F$	
 <p>Working Mode</p>	4.01	Number of outdoor unit Set the number of outdoor unit	1		1	
	4.02	Hot water mode Set whether the system has sanitary hot water circuit or not	Up to user	Blue = ON Grey= OFF	ON	
	4.03	Heating Set whether the system has water circuit for house heating or not	Up to user	Blue = ON Grey= OFF	ON	
	4.04	Cooling Set whether the system has water circuit for house cooling or not	Up to user	Blue = ON Grey= OFF	OFF	
	4.05	Basic Operation Mode Set the basic operation mode, as "Water Temperature Control" (by default) or "Room Temperature Control"	Up to user	Blue = ON Grey= OFF	OFF	

Part 4 - Installation

MENU		PARAMETER	VALUE TO BE SET	RANGE	DEFAULT
 Working Mode	4.06	DHW ECO Operation	Up to user	Blue = ON Grey= OFF	ON
		Activate or deactivate the DHW ECO Operation. For more clarity on this function, please see installation manual "Part 5 - Controls"			
	4.07	Ambient temp. to start DHW ECO operation	Up to user	[-4 - 109]	14°F
		If ambient temp. is higher than this value, compressor will work with a lower frequency (50%). For more clarity on this function, please see installation manual section 6.Usage/4. Working Mode/4.07) Ambient temp. to start DHW ECO operation			
	4.08	Heating ECO Operation	Up to user	Blue = ON Grey= OFF	OFF
Activate or deactivate the Heating ECO Operation					
4.09	Ambient temp. to start heating ECO operation	Up to user	[-4 - 109]	14°F	
	If ambient temp. is lower than this value,compressor will stop.				
 Parameters Overview	11.02 (page 2/2)	Setting button	To be set as Menu Working Mode: - Hot Water mode: set as 4.02 - Heating mode: set as 4.03 - Cooling: set as 4.04	Blue = ON Grey= OFF	
		Device Configuration: - Hot Water mode: Set whether the system has sanitary hot water circuit or not (refer to 4.02) - Heating mode: Set whether the system has water circuit for house heating or not (refer to 4.03) - Cooling: Set whether the system has water circuit for house cooling or not (refer to 4.04)			
 Water Pump Settings	12.01	Circulation pump PO type	Up to user	[AC Pump - PWM Pump]	PWM Pump
		Set the type of circulation pump inside the unit (PO). It is set by installer level.			
	12.02	Working mode of circulation pump PO	Up to user	[1-3]	Interval working mode
		To set the working mode of circulation pump for cooling/heating operation inside the unit (PO). PO can work as the following settings: 1. Interval working mode. In this setting, PO stops for a time defined by par. 13.03 after compressor stops, then runs for a time defined by par.13.04 . 2. ON constantly. PO will work constantly even if compressor stops after reaching the set temperature. 3. OFF with compressor. It means PO stops after compressor stops.			
	12.03	Pump Off interval for PO	5 min	[5-60]	6 min
		if par 13.02 is set to "Internal Working Mode", PO stops after compressor stops for this time interval.			
	12.04	Pump On time for PO	1 min	[1-10]	1 min
if par 13.02 is set to "Internal Working Mode", after compressor stops PO will run for "ON interval" time after every "OFF interval" minute stops.					
12.05	Buffer tank	ON	Blue = ON Grey= OFF	ON	
	If the system has a buffer tank = ON If the system does not have a buffer tank = OFF				
 Electrical & back-up heater settings	13.01	Heating Back-up Heater (HBH)	OFF	Blue = ON Grey= OFF	OFF
		If the application has a space heating back up heater in addition to the AH this needs to be turned on.			
	13.04	Hot Water Back-up Heater (HWTBH)	OFF	Blue = ON Grey= OFF	OFF
		If the application has a DWH back-up heater in addition to the AH, then this setting should be turned on.			
	13.07	Emergency operation	ON	Blue = ON Grey= OFF	OFF
		If the Heat Pump has faulted, the PCB should turn ON the back-up heating system automatically.			
13.08	Disactivated auxiliary heater (AH)	OFF	Blue = ON Grey= OFF	OFF	
	This function sets whether auxiliary heater is disactivated				

MENU	PARAMETER	VALUE TO BE SET	RANGE	DEFAULT
 Other Settings	14.01 Motorized diverting valve switching time: (Example: WATSS: 6 min LK Armature: 1 min) Set the switching time of the motorized diverting valve depending on switching the water flow fully between DHW and Heating/Cooling circuit.	Refer to the Spread Sheet of Commutation Valve	[0-10]	6 min
	14.02 Diverting valve-power on time Set how long the motorized diverting valve should be powered, for switching the water flow fully between DHW and Heating/Cooling circuit.	0 - Always with Power	[0-16]	0 - Always with Power

Table 5 - Parameters Setting (Scheme 3 and 4)

4.3 Tools needed

The tools required for each installation can vary from project to project. Prior to installing the product, please refer to all guidelines in this manual and ensure all appropriate tools are present.

! WARNING

THE INSTALLATION OF THE PRODUCT SHOULD BE HANDLED BY PROFESSIONAL INSTALLERS OR UNDER THEIR INSTRUCTIONS.

4.4 Installation indoor unit

4.4.1 Choosing an installation location

1. The indoor unit should be installed indoors, mounted on a wall.
2. The indoor unit must operate in a dry, well-ventilated location.
3. There should be no volatile, corrosive, or flammable liquids or gases nearby.
4. Ideally, the unit should be as close as possible to the water supply system.
5. Try and leave enough space in the area around the unit to simplify future maintenance.

Please choose a suitable position to install the indoor control unit as follows:

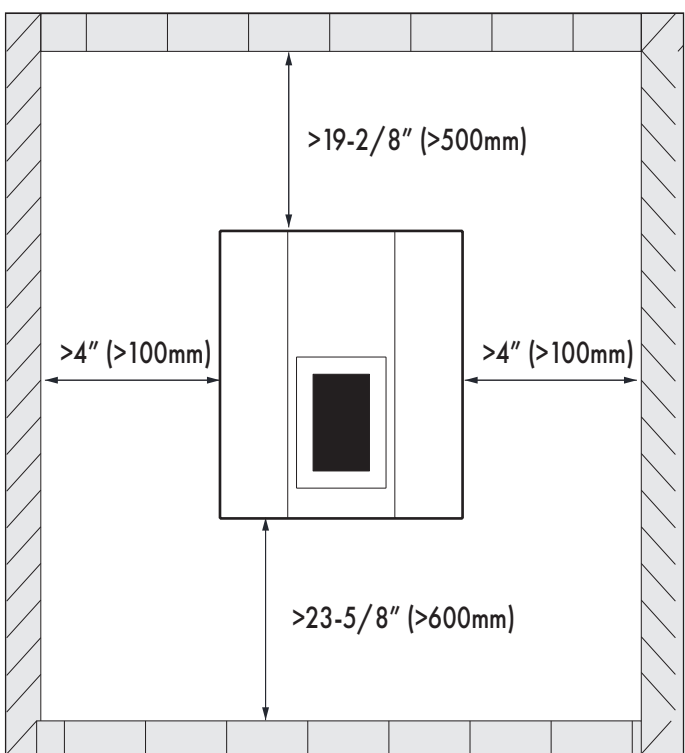

Figure 30 - Indoor Unit - Minimum Clearances

4.4.2 Installation Process

! WARNING

DO NOT PROCEED If you do not know how to securely fasten a wall-mounted bracket. If you are unsure, it is best to consult a professional. Improper installation could result in serious injury or property damage as well as loss of warranty.

To ensure the indoor unit is properly secured the below steps must be completed fully. For the unit to be stable and ensure proper operation a sturdy/reliable mounting surface should be selected. For example- Concrete walls, studded sheetrock or full wood walls.

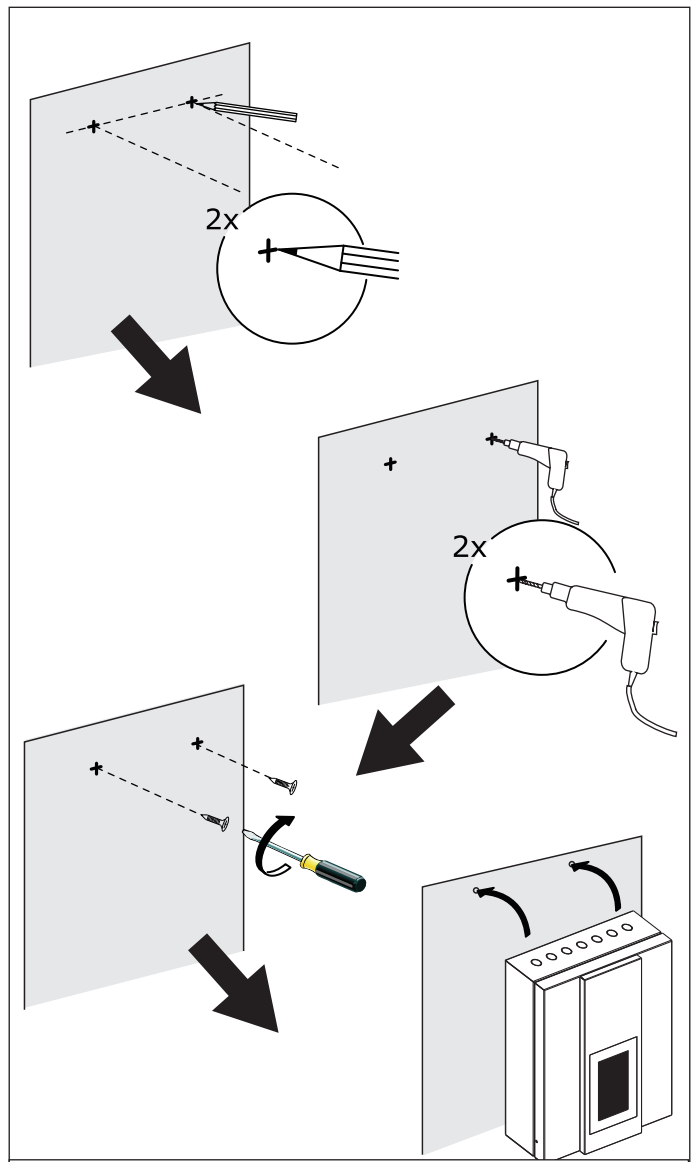

Figure 31 - Indoor Unit installation

Part 4 - Installation

If a full wood wall is selected, the use of anchors is optional however, the installer must consider the full weight of the indoor unit and select proper construction fasteners (screws) to hold the full weight of the indoor unit. Failure to do will result in a loss of warranty.

1. Locate and retrieve the factory supplied screws from the accessory bag. Measure the mounting holes on the back of the indoor unit and mark the holes on the wall ensuring a level installation.
2. Select an appropriate drill bit size for the screws.
3. Tighten the screw into the wall (or anchors) leaving enough screw exposed to hang the unit from.
4. Hang the unit on the screws. Adjust depth of screws if needed to keep the indoor unit as flush as possible to the wall.

4.4.3 Room temperature sensor

If the application requires a room temperature sensor then room temperature sensor (Tr) is recommended to be placed in a ideal position of the house to check the room temperature. Thus the unit can have room temperature control mode (please refers to 9.04 Basic Operation), and room temperature compensate function (please refers to 1.16 Room temp. effect on Heating Curve).

4.5 Installation outdoor unit

4.5.1 Choosing a location for the Outdoor unit.

! WARNING

Failure to adhere to the location guidelines below may result in poor performance and can result in a loss of warranty.

1. The outdoor unit must be installed outside in a open space, a corridor, a balcony or roof, or hung onto the wall.
If a balcony or rooftop installation is required, all local codes must be followed to properly secure the outdoor unit from ambient conditions.

2. The outdoor unit shall be placed in dry and well-ventilated environment; If the monoblock unit is installed in humid environment, electronic components may get corroded, or short-circuited because of heavy humidity.
3. Monoblock unit mustn't be installed in an environment where volatile, corrosive or flammable liquid or gas exists.
4. When selecting a location to install the outdoor unit, please be mindful of windows to bedrooms as the outdoor unit will omit noise during normal operation. See specification table for noise levels.
5. When installing the unit in harsh climatic conditions, sub-zero temperatures, snow, humidity..., please raise the unit above the ground by about 50cm.
It's recommended to install an awning above the monoblock unit, to protect the snow from clogging in the air inlet and outlet and ensure the normal running.
6. Please ensure there is drainage system around the location, to drain the condensate water under defrosting mode.
7. When installing the unit, tilt it by 1 inch/ft for rain water evacuation.
8. When choosing a location please do not install the outdoor unit where kitchen exhaust will be exposed to the outdoor unit. The oil smoke, grease etc.. can be damaging to the coils and void warranty.
9. Please don't install the indoor control unit and monoblock unit in damp locations, otherwise it may cause short-circuit or corrosion of some components. The unit should be free from corrosive and moisture surrounding. Otherwise the lifetime of the unit might be shortened.
10. Please ensure enough space around the monoblock unit, for better ventilation and maintenance. Please refer to the illustration below.

NOTICE

Install the heat pump strictly according to the suggestions in the pictures.

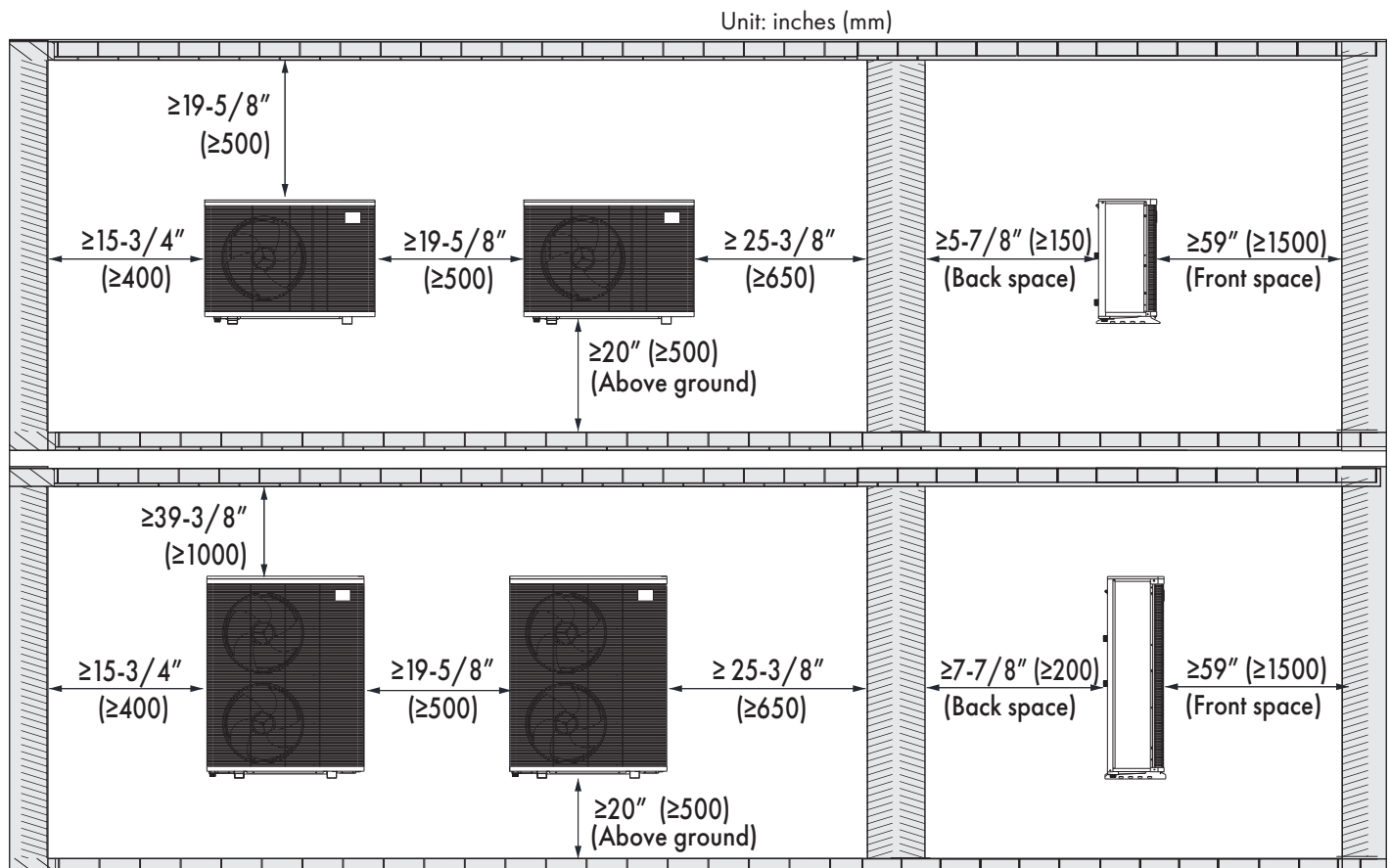

Figure 32 - Outdoor Unit - Minimum Clearances

4.5.2 Mounting of outdoor unit

Make sure the installation meets following requirements:

1. The outdoor unit shall always be mounted above the highest anticipated snow level, per local codes, or 20" (whichever is greater)
 2. The unit shall be mounted on a bracket either supplied/approved by the manufacturer or built to withstand 5x the outdoor unit weight (see specification table)
 3. All wall brackets or stand shall be selected based on unit weight and unit size.
 4. Prior to connecting any piping, the wall/floor mount shall be confirmed to be appropriate. If there are any concerns- **DO NOT INSTALL** the unit and call in to technical support for approval/confirmation.
- * The hole in the structure for the piping shall be angled to eliminate any moisture/water staying in the hole or freezing.

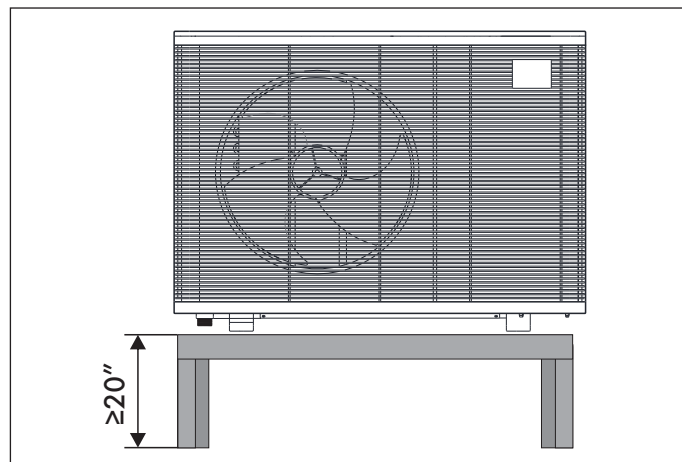

Figure 33 - Outdoor Unit - Installation above the snow level

CAUTION

Hole for piping kits should lean to outside a little bit (≥ 8 degrees), to keep rain water or condensate water from flowing back indoors.

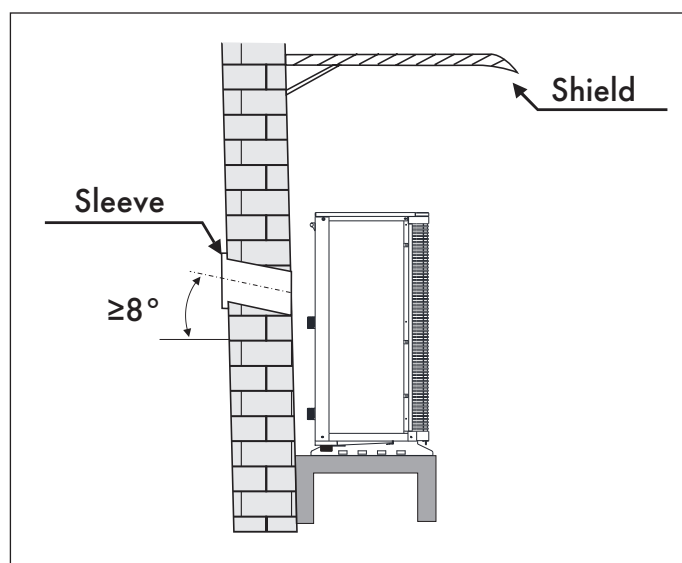

Figure 34 - Outdoor Unit - Correct Hole for piping

4.6 Heating /cooling distribution system

Users are heavily recommended to install a buffer tank into the chosen configuration, especially when the method of hot water distribution is below 5gallons/3412 btu's of water volume.

Note:

Buffer tank is always recommended to be included in the system , especially when the distribution system has water volume less then 5gallons/3412 btu's. It should be installed between heat pump and distribution system , in order to:

- 1) Ensure heat pump unit has stable and enough water flow rate.
- 2) Store heat to minimize fluctuation of system heating/cooling load.
- 3) Extend the water volume of distribution system for proper working of heat pump unit.

If the total system volume is adequate for the heat pump, than a buffer tank may not be required. In this case, the TC sensor (normally for the buffer tank) shall be placed (well insulated) on the return water pipe to the unit.

Part 4 - Installation

4.7 Water pipe connection

When selecting the proper pipe sizes, be sure to account for pressure drop, pipe materials, any fittings (valves, elbows etc..) and required flow rate through the outdoor unit. If the calculations are not correct and the pump is not sized properly, the system will not perform at its best and could not run properly. Please note: for the hydrobox indoor unit, the pump is included. Please refer to the pump characteristics for proper flow rate, pipe sizing etc..

4.7.1 Filtration

In order to prevent any impurities and to preserve water quality, a filter is recommended to be installed (see piping diagrams for recommended locations). Consult filter requirements for proper installation/location.

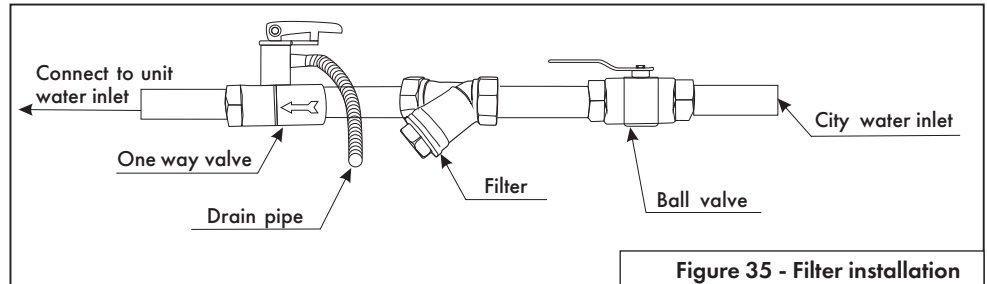

Figure 35 - Filter installation

4.7.2 Insulation

All pipes running hot water should be well-insulated. No gaps should exist between insulation and outer pipe. Keep the check valves uncovered for future maintenance.

4.7.3 Three way valve

The 3-way valve is operated by 120 V AC terminals "DV" (Line) and "Na" (Neutral), which are powered ON during cooling and space heating demands and are OFF during DHW demands.

Note: Only 2-wire 120 V AC three-way valves are directly compatible with the Verta Control Box. To operate a 3-wire three-way valve an external NO/NC relay is required; wire the "DV" (Line) and "Na" (Neutral) to the relay coil and wire the relay contacts as required to operate the valve. Follow the instructions provided with the to the 3-way valve.

Note: Choose a three-way valve with a $C_v > 11$ to avoid adding unnecessary flow restriction.

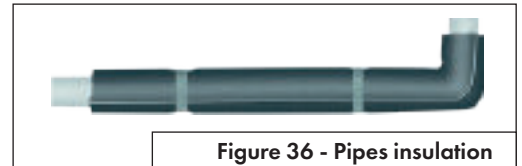

Figure 36 - Pipes insulation

4.7.4 Expansion vessel

The installer is responsible for ensuring that the expansion vessel is suitably sized in relation to the system's water content, regardless of the valves that can exclude certain parts of the hydraulic circuit.

4.7.5 Water Quality Standards

- Water should contain less than 300 ppm of chloride (in temperatures less than 140°F)
- The pH value of the water should be between 6 to 8.
- No water containing ammonia should pass through this unit.

If the water quality is bad or the water flow is too weak, scale formation and clogging may eventually occur, which lowers efficiency of cooling and heating and can cause abnormalities to occur.

Use pre-cleaned water, or purified water. Good water quality keeps the unit running in high efficiency.

The following values for water quality will be required for the installation. Failure to fill the system, monitor and maintain the water quality to the below parameters will result in a denial of warranty.

Water constituent + parameters	Unit	Acceptable range
pH-value		
Saturation-Index SI (delta pH-value)		-0.2 to +0.2
Total hardness	°dH	<15
Conductivity	µS/cm	<500
Filtered substances	mg/l	<30
Chlorides	mg/l	<250
Free Chlorine	mg/l	<0.5
Hydrogen sulphide (H ₂ S)	mg/l	<0.05
Ammonia (NH ₃ /NH ₄ +)	mg/l	<2
Sulphates	mg/l	<100
Hydrogen carbonate	mg/l	<300
Sulphide	mg/l	<1
Nitrate	mg/l	<10
Nitrite	mg/l	<0.1
Iron	mg/l	<0.2
Manganese	mg/l	<0.05
Free aggressive carbonic acid	mg/l	<0.5
Ferrite hydroxide Fe O (black)	mg/l	< 2.5 mg/L 50% diameter < 10 µm
Iron oxide Fe O (red) <	mg/l	2.5mg/L. Diameter less than 1 µm
Sand	mg/l	<3mg/L diameter is between 0.1~0.7µm

Table 6 - Water quality

NOTICE

The values stated are guide values which show variations under certain operating conditions.

4.8 Wiring diagram

Indoor Control Box

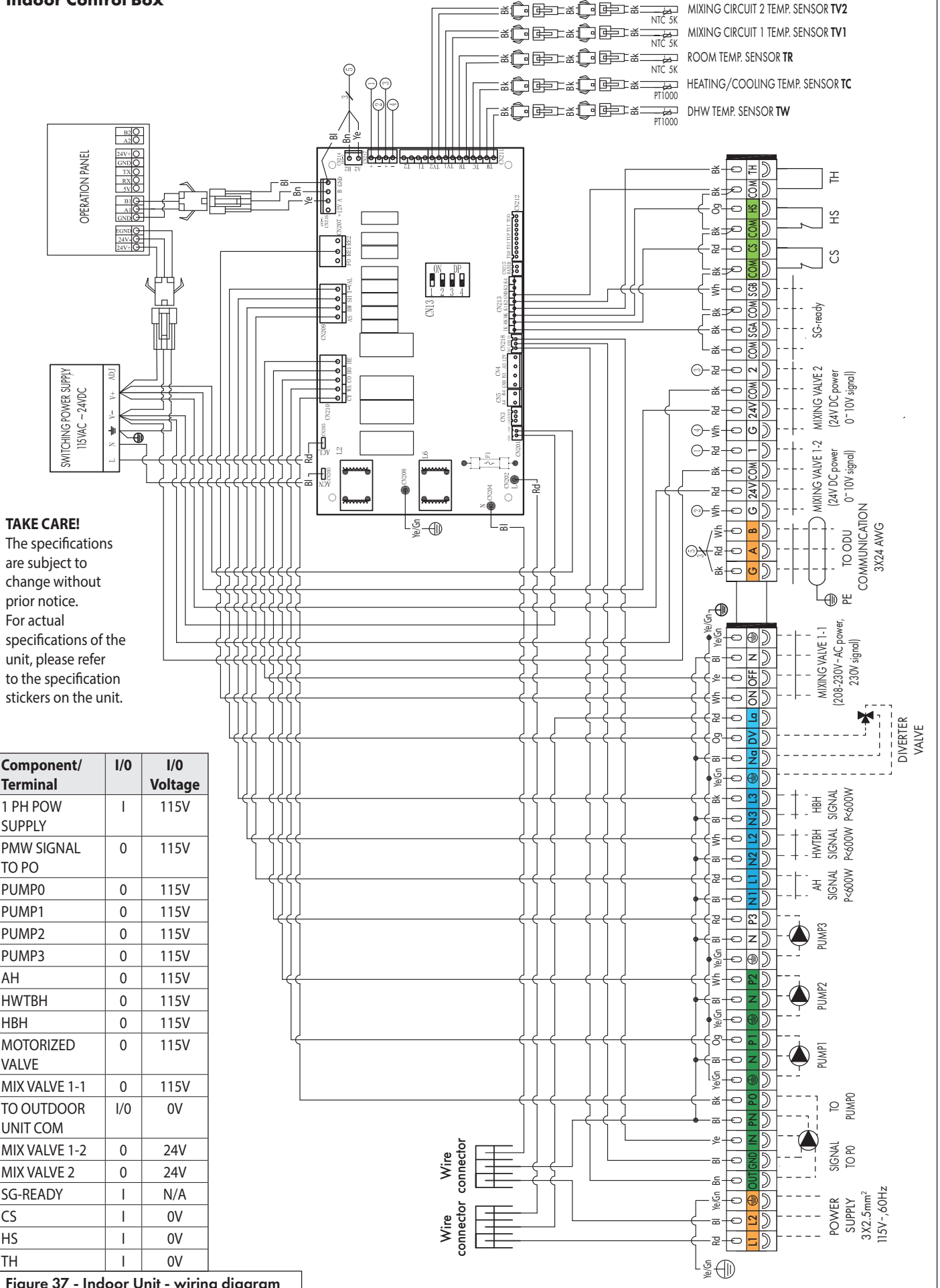
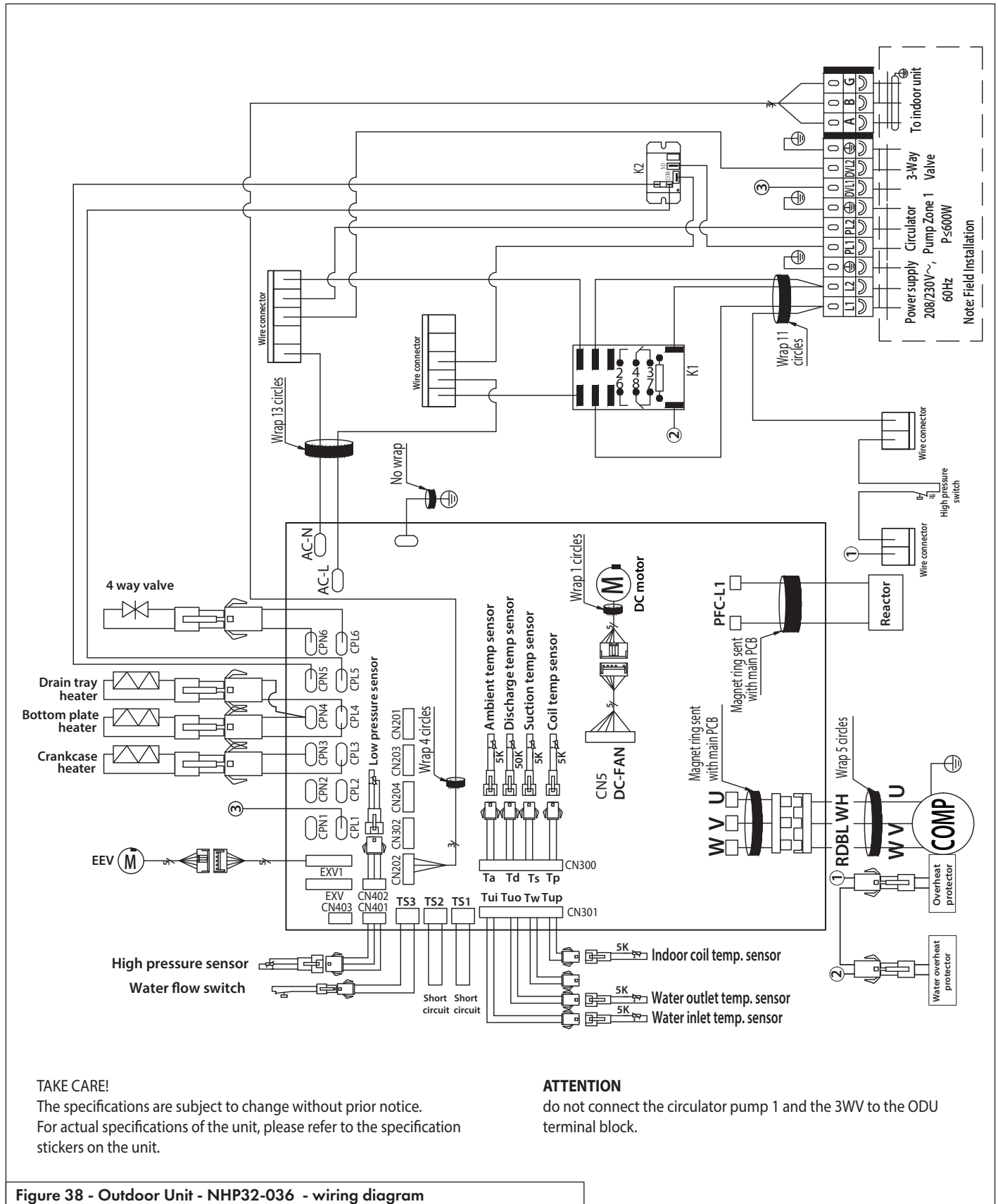

Figure 37 - Indoor Unit - wiring diagram

Part 4 - Installation

Monoblock unit - NHP32-036



TAKE CARE!
 The specifications are subject to change without prior notice.
 For actual specifications of the unit, please refer to the specification stickers on the unit.

ATTENTION
 do not connect the circulator pump 1 and the 3WV to the ODU terminal block.

Figure 38 - Outdoor Unit - NHP32-036 - wiring diagram

Monoblock unit - NHP32-060

TAKE CARE! The specifications are subject to change without prior notice. For actual specifications of the unit, please refer to the specification stickers on the unit.

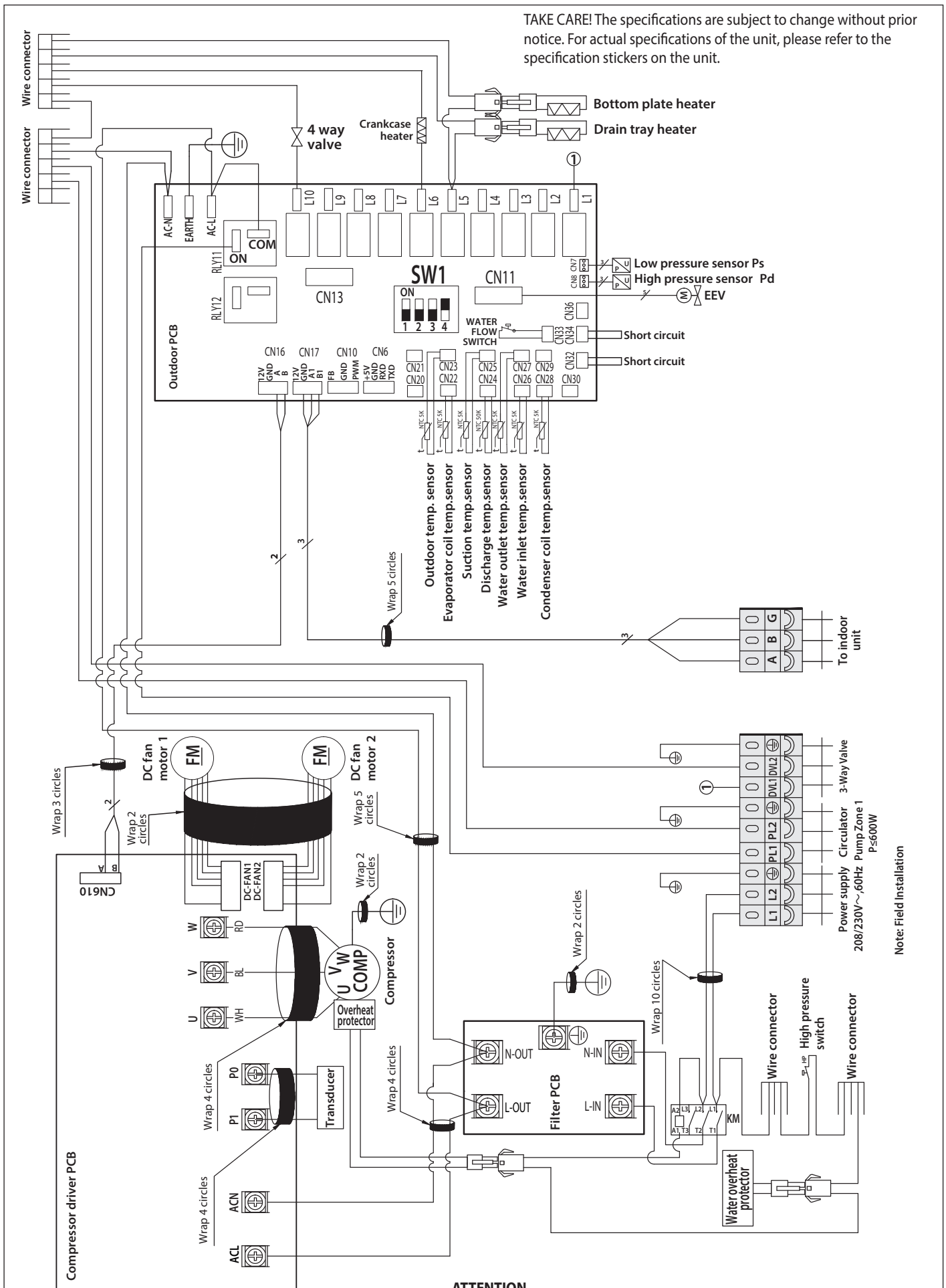

Figure 39 - Outdoor Unit - NHP32-060 - wiring diagram

ATTENTION do not connect the circulator pump 1 and the 3WV to the ODU terminal block.

Part 4 - Installation

4.9 Wiring

4.9.1 Explanation of terminals

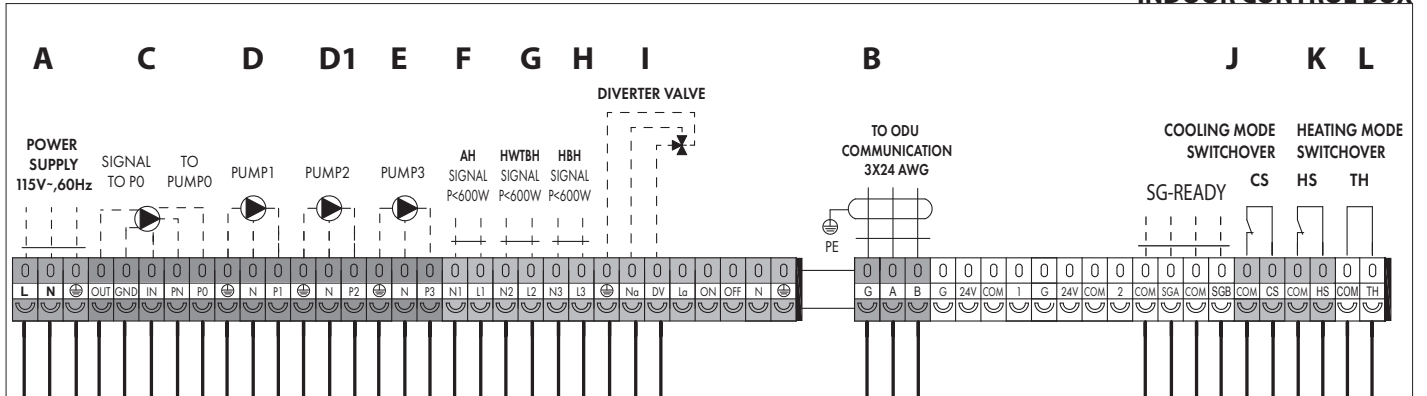

1) Power and communication cable connection

A: Unit power supply

Unit power supply. Should be connected to mains power supply.

B: Communication cable (supplied with the unit)

NOTICE

The shielding layer of the Communication cable between IDU and ODU should be grounded, with one grounding connection at each IDU and ODU.

Field wiring

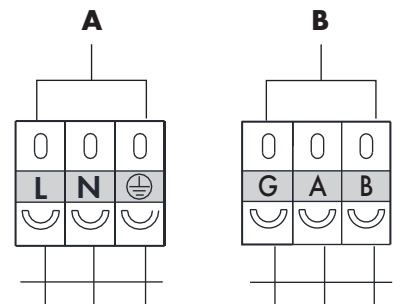

2) Pump connections

C: Water pump (P0)

for heat pump circulation.

D: Water pump (P1)

for Heating & Cooling circuit 1.

D1: Water pump (P2)

for Heating & Cooling circuit 2.

E: Water pump (P3)

for DHW.

Field wiring

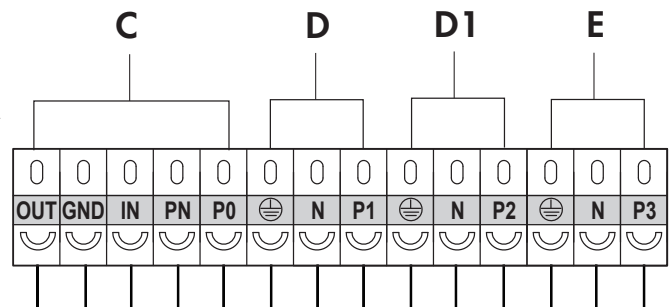

If there is an external water pump in heating, cooling and hot water system, it can be connected to these ports, to be under the control of indoor unit.

3) Backup Heater and Diverter valve connections

F: Signal output to Auxiliary Heater (AH), which will be used as auxiliary heating source for both heating and DHW operation. Heater must be less than 600W.

G: Signal output to Hot Water Tank Backup Heater (HWTBH), which will be used as backup heating source for DHW operation only. Heater must be less than 600W.

H: Signal output to Heating Backup Heater (HBH), which will be used as backup heating source for Heating operation only. Heater must be less than 600W.

I: 3-way diverter valve, for diverting water flow between DHW and Heating/Cooling. "DV" is powered when diverting flow to Heating/Cooling, and not powered when diverting to DHW.

Field wiring

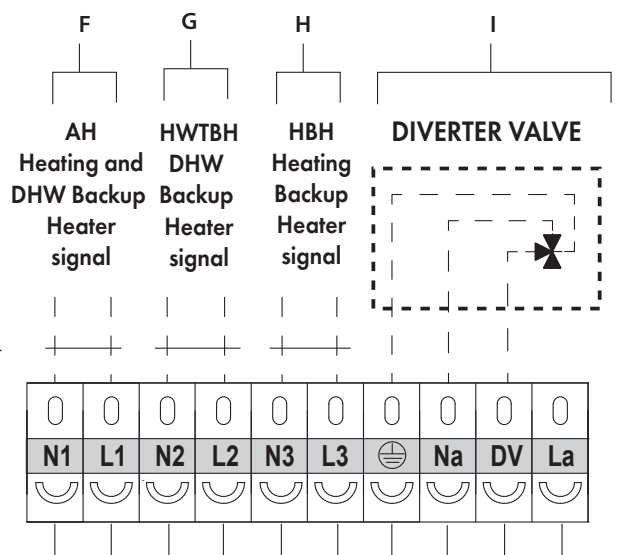

4) Cooling and Heating Mode Switchovers connections

J- K: Cooling and Heating Mode Switchovers

This unit is capable of switching between heating and cooling automatically, according to the ambient temperature, or external signal input. Please refer to the user's manual for more detailed explanations on ambient temperature setting. For external signal input, the external signal should be connected to "Cooling mode switch" (CS) for cooling operation, and "Heating mode switch" (HS) for heating operation.

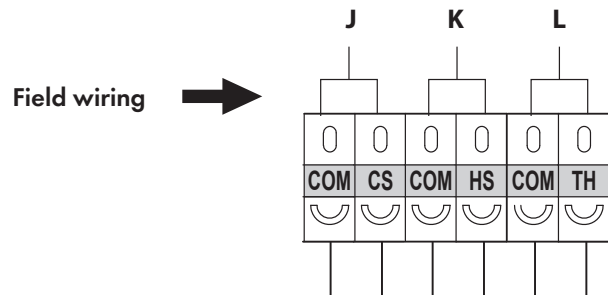

L: High demanding distribution system switch

- When two heating distribution systems are connected, unit should always take the set temperature for high demanding circuit, which needs higher temperature in heating and lower temperature in cooling operation, as the set temperature for the heat pump unit.
- However, when this high demanding circuit is not needed or has reached the set temperature, heat pump unit can switch the heat pump set temperature to the values set for the other circuit, for better efficiency.
- When "CLOSE" signal is received, unit works with high demanding. When "OPEN" signal is received, unit works with low demanding.

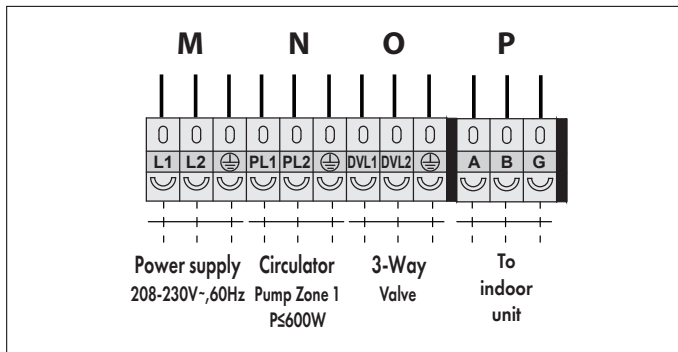

OUTDOOR AIR TO WATER HEAT PUMP

5) Power and communication cable connection

M: Unit power supply

Unit power supply. Should be connected to mains power supply.

N: Pump zone 1

CAUTION

These terminals provide 230vac power out when the indoor unit control has a demand for the PO pump. They can be used instead of the indoor unit terminals if required.

O: 3-Way Valve

CAUTION

These terminals provide 230vac power out when the indoor unit control has a demand for the 3way valve. They can be used instead of the indoor unit terminals if required.

P: Communication cable (supplied with the unit)

NHP32-036

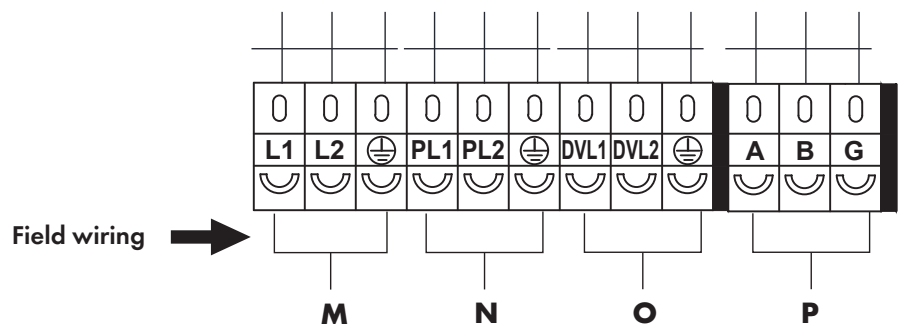

NHP32-060

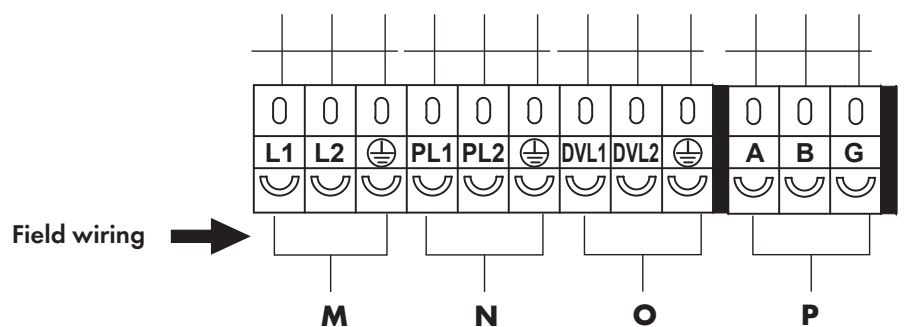

Part 4 - Installation

4.9.2 Wiring Preliminary Precautions

! WARNING

- All wiring should always be done by a qualified licensed electrician and in accordance to local and federal standards. If there is any doubts about the wiring, the installation should stop and the installer should contact technical support before attempting to wire.
- All wiring should be done with the main breaker in the off position to avoid damage to the unit, injury and possibly death.
- All wiring connections shall be properly secured before applying power.
- Please ensure all wire sizes, breakers and connections are in accordance to local and federal laws, regulations and guidelines. Please also refer to the rating plate and specifications table (Table 2) to ensure proper voltage.

4.9.3 Suggested wiring locations

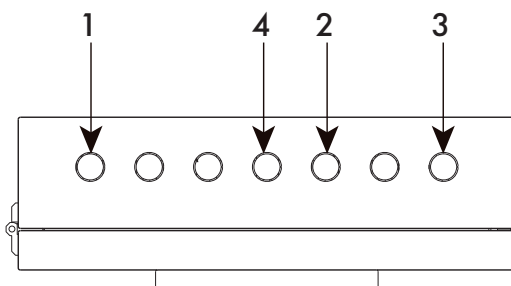
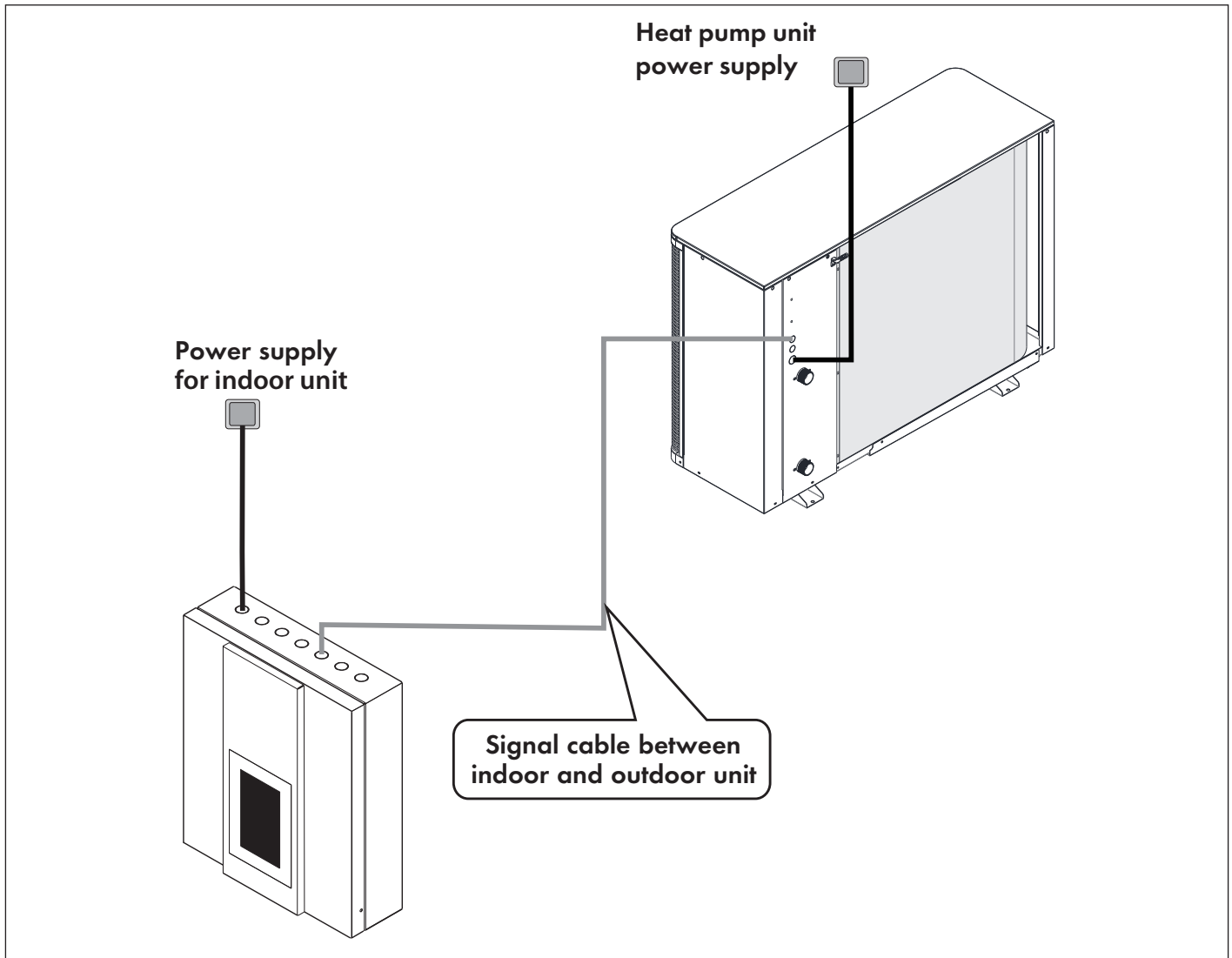

Position	Description
1	Power supply for indoor unit
2	Communication with outdoor unit
3	Sensor: TC, TW, TR, TV1, TV2
4	Signal for Auxilliary heater (AH)

Figure 40 - Indoor Unit - Cable routing

4.9.4 Wiring Process

1. Open the indoor unit's front panel.

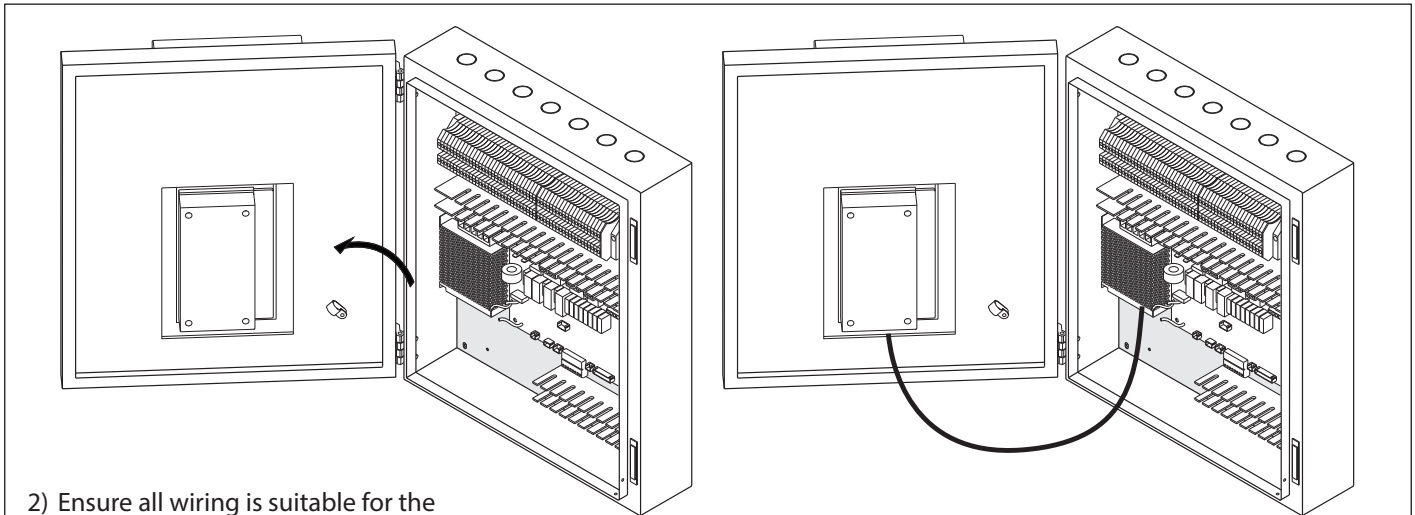

2) Ensure all wiring is suitable for the length and amperage of the unit. See specifications table and rating plate for details.

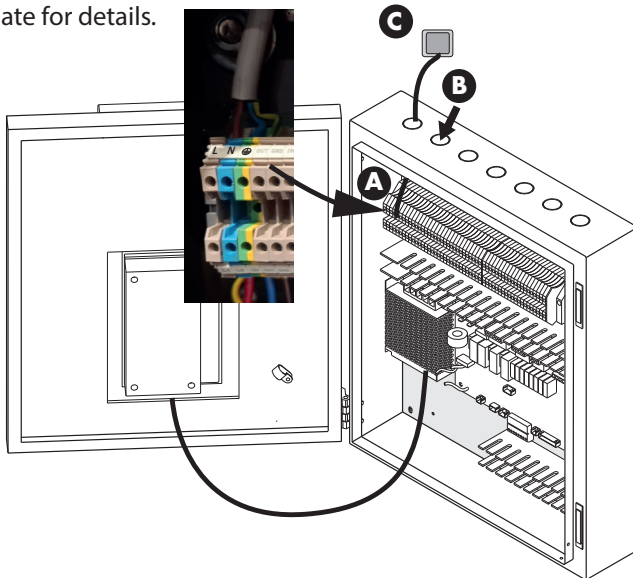

- A. Utilizing the knockouts on the top of the indoor unit, feed the wire through and make sure there is proper strain relief per local codes. Connect to heat pump power supply "L, N and Ground".
- B. Properly secure the wiring to ensure there is no chance the wire can become loose or fall out during operation.
- C. Connect to proper breaker at panel (see specifications and nameplate for ratings)

Figure 41 - Indoor Unit - Power Cable connection

Power cable

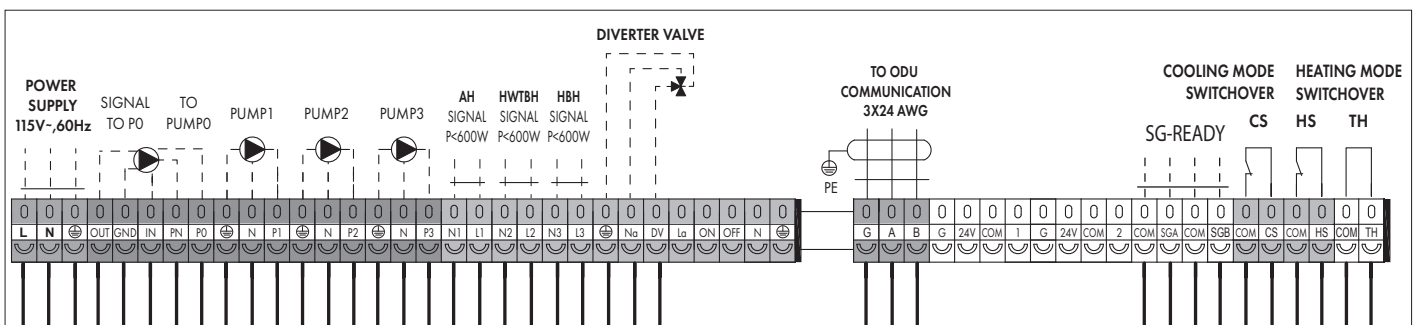

Communication cable - see next page



Part 4 - Installation

- 3) Connect the communication cable between the indoor and outdoor unit:
Retrieve the signal cable from the accessories bag.

NOTICE

When securing all wire connections, be sure not to tighten the connectors on the casing of the wire. The bare wire must come in contact with the connectors in the units.

- A.** Insert one end of this cable through the cable gland on the bottom of the indoor unit, and connect it to A and B on the appropriate terminal block.
- B.** Fasten the cable gland to ensure the cable won't get loose.
- C.** Connect the other end of the cable to the terminal block on the outdoor unit. A, B, and G on the indoor unit should be connected with A, B, and G on the outdoor unit, otherwise communication failure error may occur.

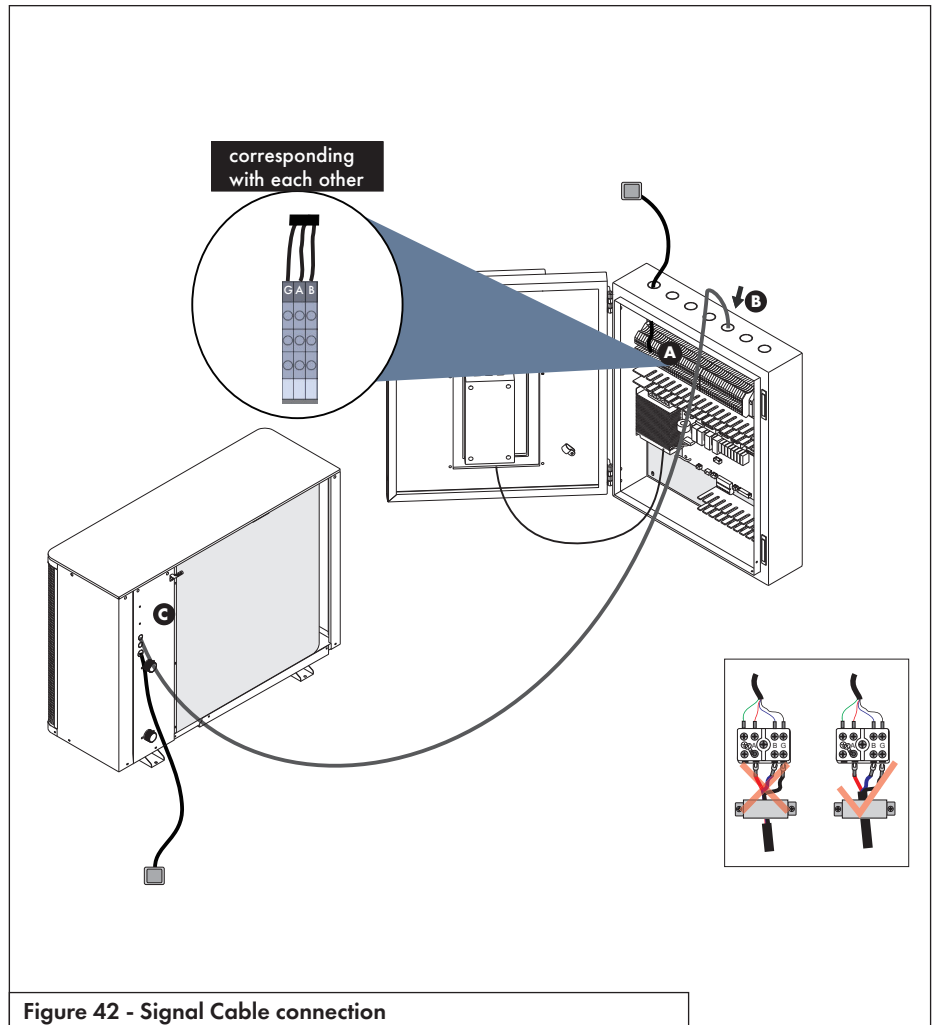

- 4) When choosing a proper wire size for the main power connection on the outdoor unit, please refer to the specifications table and rating plate for MCA and MOPD. Ensure proper compliance with national electric codes and local safety regulations.

NOTICE

When securing all wire connections, be sure not to tighten the connectors on the casing of the wire. The bare wire must come in contact with the connectors in the units.

- A.** Insert one end of this cable through the cable gland into the back of the outdoor unit, and connect it to the appropriate terminal block.
- B.** Fasten the cable gland to ensure the cable won't get loose.

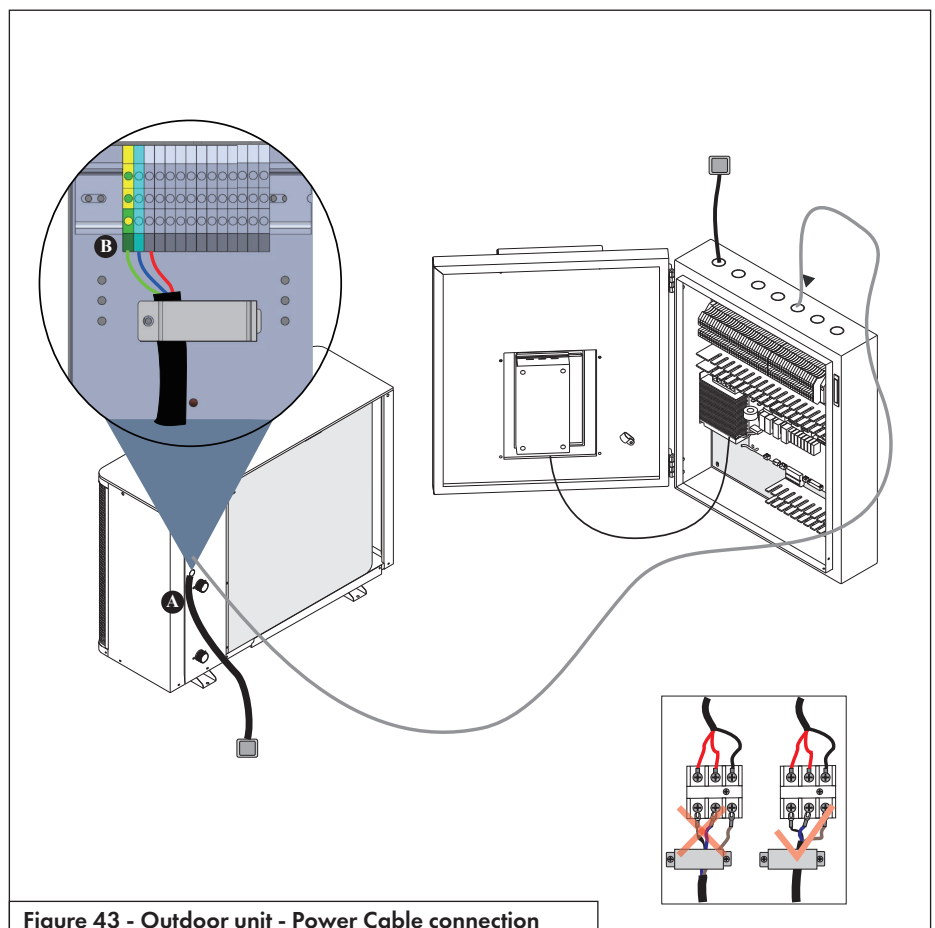

5) Connect the sensors and communication cables to the indoor unit.

- Retrieve all sensors and communication cables from the accessories bag.
- Connect all sensors to the communication cables, and insert the male end into the indoor unit through the cable glands.
- Connect them to the female quick connectors inside the indoor units.
- Place all sensors in the correct positions.
- After everything is connected, fasten the cable glands to prevent cables from loosening.

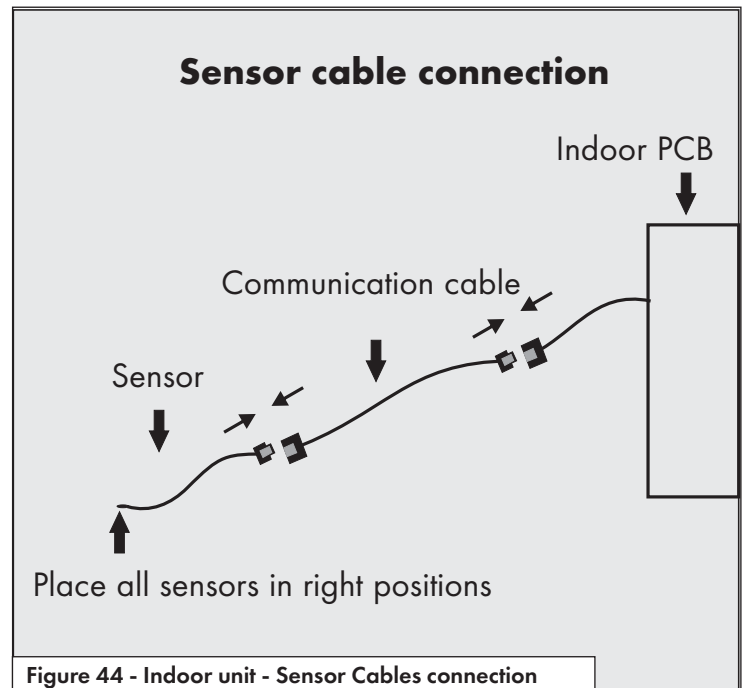

6) Re-install the electrical box cover, as well as the small handle on the back of the outdoor unit, and close the the indoor unit door.

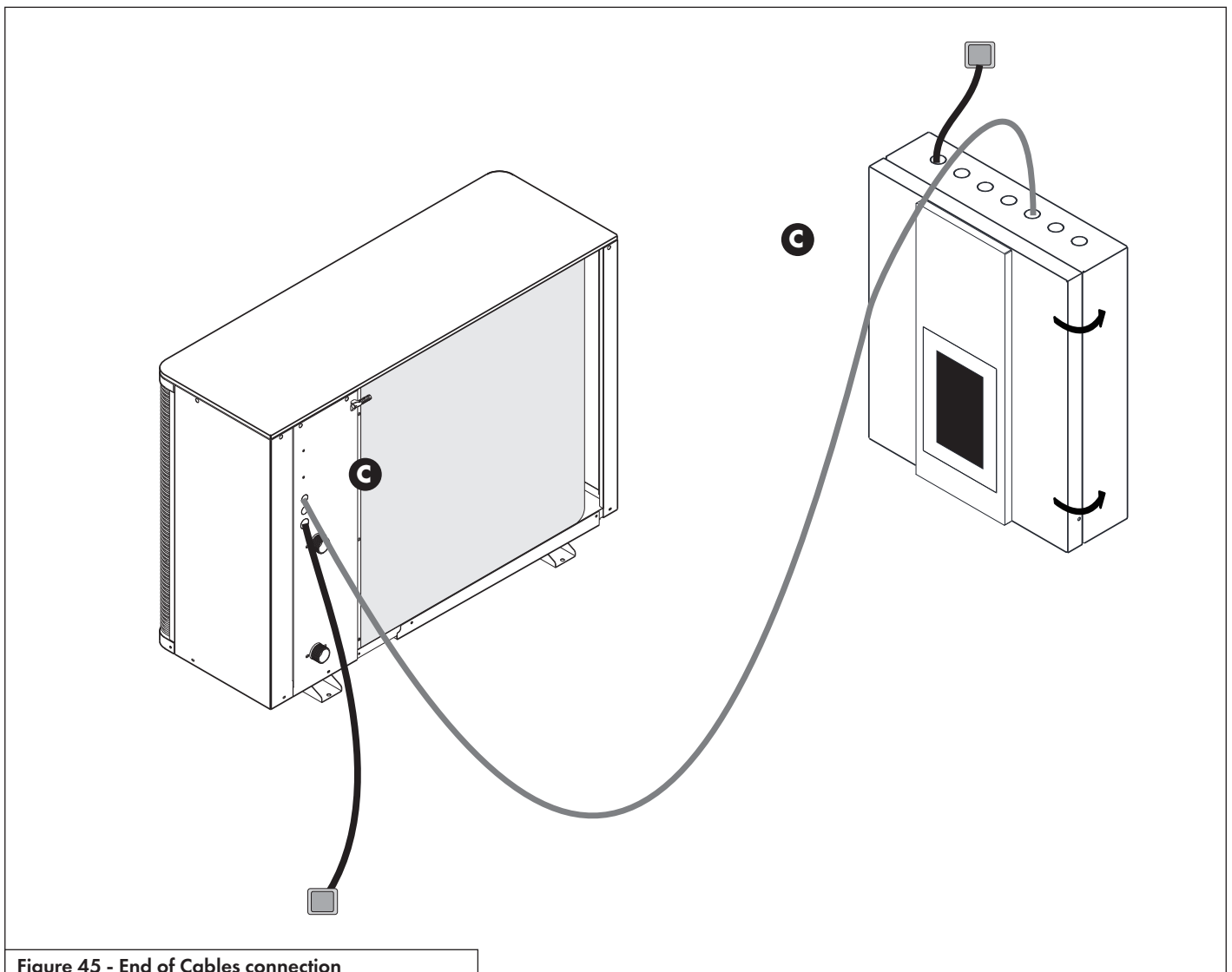

Part 4 - Installation

4.10 Test run

! WARNING

After piping and wiring is finished, please fill the water system with water and purge out air in the system before start-up.

4.11.1 Before start-up

The list of verifications below must be performed before the unit starts up, to ensure best possible conditions for smooth long-term operation. The list is not exhaustive, and should only be used on a minimum reference basis:

- 1) Make sure the fans are rotating freely.
- 2) Confirm correct flow directions in water piping.
- 3) Verify all system piping matches installation instructions.
- 4) Check the voltage of the unit power supply and make certain it complies to authorized limitations.
- 5) The unit must be properly grounded.
- 6) Check for the presence of any damaged devices
- 7) Check all electrical connections and ensure they are secure.
- 8) Make sure there are no leaks in the piping and the space is well-ventilated.

4.11 Air Purge Procedure for the Water System

- 1) First, open all the air release valves on the water system piping, then open the water supply valve to fill the system with water. As water is injected, air will be expelled through the air release valves until water sprays out of the manual air release valve. Then close the manual air release valve, or if using an automatic air release valve, ensure no air is being discharged to complete the initial air removal.
- 2) After the initial filling and air removal of the system are complete, proceed to a second air removal. For the second air removal, all terminal loads should be opened simultaneously, and the main unit should be set to the system air removal mode (only the water pump operates: the controller's air removal operation process is shown in the diagram below). This will expel any remaining small amounts of air from the system piping and loads. After pressurizing the system for half an hour, if the system pressure does not drop and no air is discharged from the air release valves, the system air removal is complete.

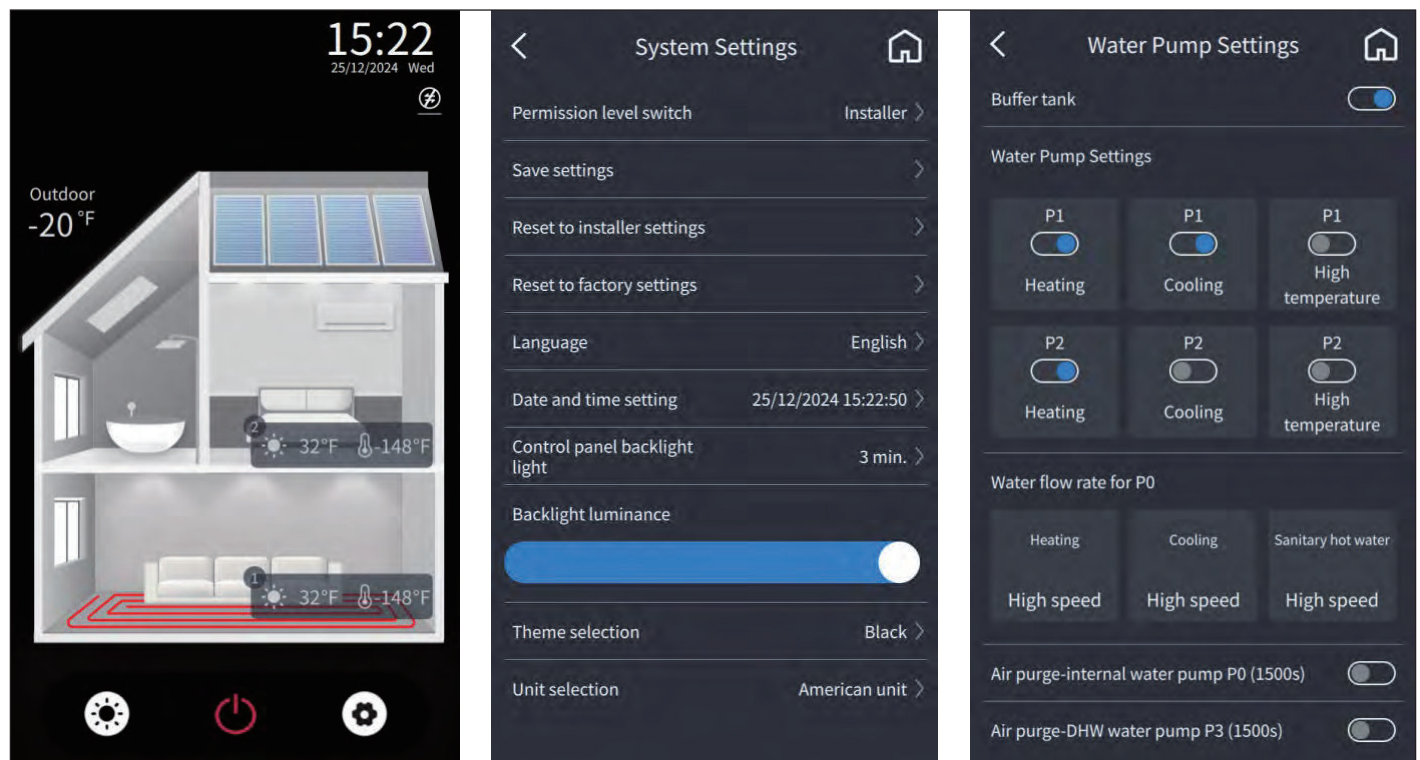

Figure 46 - Air purge Function

! WARNING

Fix any problems above if they occur. If everything above is satisfied, the unit can start up.

4.11.2 Starting Up

When the installation of the unit is completed, all water system pipes are confirmed to be well-connected, air purging is done, there are no leakages or other problems, the unit can be powered on. Turn on the unit by pressing the on/off button on the operation panel. Listen carefully for any abnormal noise or vibrations, and ensure the display of the wired controller is normal. After the unit has been on for 10 minutes and no abnormalities have occurred, the start-up process is complete. For problems and troubleshooting, please refer to the Service and Maintenance manual.

! WARNING

It is suggested to not run "heating" or "hot water" mode during ambient temperatures above 90°F otherwise the unit may easily enter protection mode.

5.1 Main Page

1. Outdoor ambient temperature
2. Sanitary Hot Water
Set hot water temperature
Current water temperature.
3. Select mode of operation
4. Access settings and parameters
5. Actual room and water temp in circuit 1 if applicable.
Shortcut to set temps in circuit 1.
6. Actual room and water temp in circuit 2 if applicable.
Shortcut to set temps in circuit 2
7. Current status of the unit (faults, electric heat etc...)

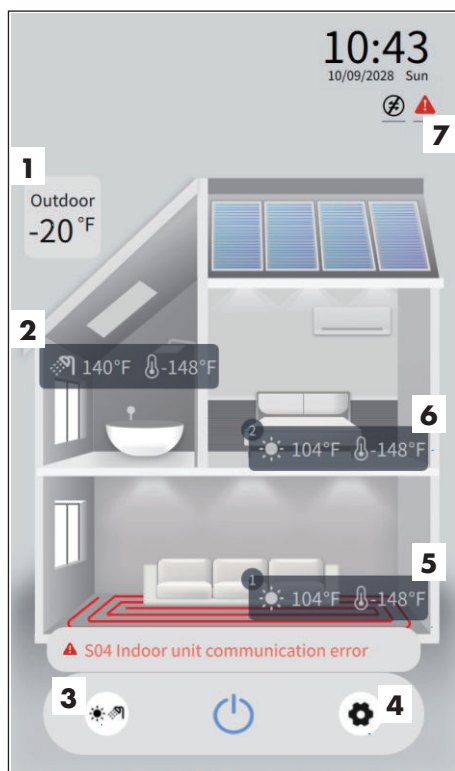

5.2 Display Symbols

1		Heating mode
2		Cooling mode
3		DHW mode
4		Anti-legionella is working
5		Anti-legionella failed
6		Sleep mode
7		Low noise mode
8		Vacation mode
9		DHW ECO
10		Heating ECO
11		Electrical utility lock
12		P0
13		P1

14		P2
15		P3
16		AH
17		HBH
18		HWTBH
19		Floor curing
20		Error for system 1
21		Error for system 2
22		Communication normal
23		Communication failed

Table 7 - Display Symbols

















Setting		
		
Heating/Cooling Circuit 1	Heating/Cooling Circuit 2	Sanitary hot water
		
Working Mode	System Settings	Timer
		
Anti-Legionella Function	Sleep and Quiet mode	Vacation
		
Fault Information Query	Parameters Overview	Water Pump Settings
		
Electrical & back- up heater settings	Other Settings	Floor Curing
		
Software Upgrade		

Table 8 - Settings icons

5.3 Settings Menu/Symbol

1. Heating/Cooling Circuit 1 (Zone 1)

Heating/Cooling Circuit 1 (Zone 1)			
	PARAMETER	RANGE	DEFAULT
1.01	Heating / Cooling Stops based on Water ΔT	2 - 9 (°F)	4°F
1.02	Heating /Cooling Restarts based on Water ΔT	2 - 9 (°F)	4°F

ΔT is a temperature deviation value.
 Set ΔT to stop (1.01) or restart(1.02) the unit.
 Unit stops running when [Tset+ΔT] in heating operation, or when [Tset-ΔT] in cooling operation.
 For example, in heating mode, if Tset=104°F, while ΔT (1.01) =4°F, and ΔT (1.02) =4°F, when the water temperature is higher than 108°F (104+4°F), unit stops. when the water temperature is higher than 108°F (104+4°F), unit stops. When unit stops and the water temperature drops lower than 100°F (104-4°F), unit restarts

Heating/Cooling Circuit 1 (Zone 1)			
	PARAMETER	RANGE	DEFAULT
1.03	ΔT Compressor Speed-Reduction	2-18 (°F)	4°F

This parameter is used to set a temperature that compressor starts to slow down its speed.
 Normally if actual water temperature is lower than [Tset-ΔT] (in heating mode) or higher than [Tset+ΔT] (in cooling mode), compressor always works with its maximum allowable speed. If real temperature is between [Tset-ΔT,Tset] in heating mode or [Tset, Tset+ΔT] in cooling mode, compressor will adjust frequency, to balance the total heating output and system heating load. This setting is to balance the comfort and energy-saving demand. If this value is set too big, even if the room is not warm (or cool) enough, compressor will slow down its speed quite soon to save energy.
 If this value is set too small, even if the room is warm (or cool) enough, compressor will slow down its speed quite late, which consumes more power.
 For example, in heating mode, if Tset=104°F and ΔT=4°F, compressor will work at maximum speed to get 100°F as soon as possible, then it will lower the speed. But if even the compressor works in its lowest allowable speed, the water temperature still goes over [Tset+ΔT], unit stops.

1.04	Set temp. for heating (fix flow water temperature)	68 - par. 1.12 (°F)	104°F
1.05	Set temp. for cooling (fix flow water temperature)	par. 1.11- 77 (°F)	50°F

This option can be set only when "Water Temperature Control" is selected for "basic operation mode".
 If heating curve function is off, a fixed water temperature for heating can be set via "Set Temp For Heating" (1.04); If cooling curve function is off, a fixed water temperature for cooling can be set via "Set Temp For Cooling"(1.05).

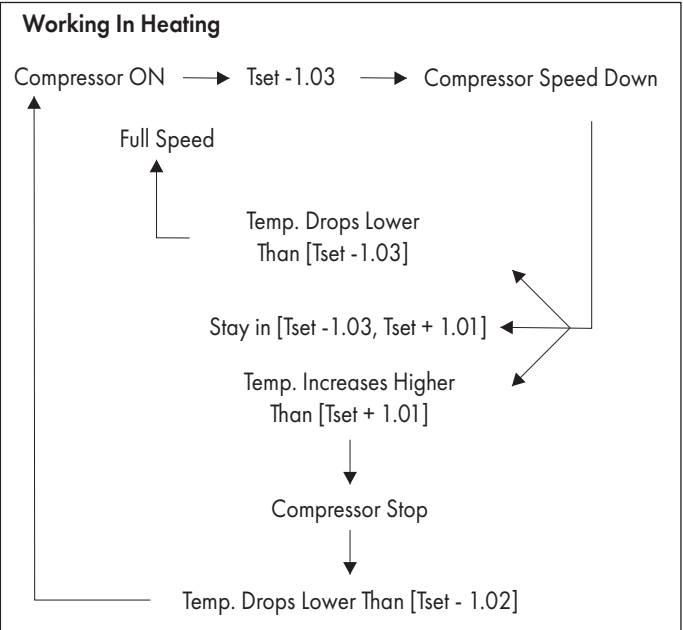

Part 5 - Controls

Heating/Cooling Circuit 1 (Zone 1)			
	PARAMETER	RANGE	DEFAULT
1.06	Set the heating curve 1	ON - OFF	
Set whether heating curve 1 function is needed or not. If heating curve function is off, set this parameter to off, then you can set a fixed water set temperature under heating mode via parameter "Set Temp For Heating". If Heating Curve 1 is on, user can set a this parameter to create a suitable curve which fits the application. The horizontal coordinate is the ambient temperature and the vertical coordinate is the water temperature. When the curve function is turned on, the system will use the water temperature corresponding to the current ambient temperature in the curve as the set temperature for heating in circuit 1. You can modify the data to get ideal curve.			
1.07	Set the Cooling curve 1	ON - OFF	
Same as setting in 1.06, just modify heating to cooling mode.			
1.08	Room temp. effect on heating curve	ON - OFF	
Turn ON/OFF this function, to decide if room temp. need to have a influence on heating curve or not.			
1.09	Ideal room temp. in heating	54 - 95 (°F)	73°F
1.10	Ideal room temp. in heating	59 - 95 (°F)	97°F
Set an ideal room temperature in heating (1.09) or in cooling (1.10) - <i>only if room sensors are installed</i> . When in Room Temperature Control mode, this parameter will also be the Room Set Temperature for heating (1.09) or cooling (1.10). For example: If 1.08 (Room temp. effect on heating curve) is on, current the unit works in heating mode, water set temperature in the heating curve is 95°F, and room temperature is 81°F, while 1.09 (Ideal Room Temp.in Heating) is set to 72°F, then the unit will deduct (81°F-72°F) =9°F from water set temperature, which means unit will take (95°F-9°F)=86°F as the final set water temperature.			
1.11	Low temperature limit1	41 - 77 (°F)	45°F
1.12	High temperature limit1	68 - 140 (°F)	131°F
These two parameters are used by the installer level, to set the set temperature range for circuit I for safety purpose.			
1.13	Mixing valve 1	ON - OFF	OFF
Set whether circuit 1 has a mixing valve connected or not.			

Table 9 - Heating/Cooling Circuit 1 (Zone 1) parameters

Tips:

When Mixing valve is needed?

In general, if system water temperature may higher(lower) than temperature that are need for this circuit, then a mixing valve is needed.

- A. If a system has two circuits, these two circuits may require different water temperatures. Heat pump has to take the higher(lower) setting among two circuits as the set temperature for heat pump when it works in heating(cooling). Thus, a mixing valve is needed for the circuit that with lower(higher) setting to ensure it gets water with correct temperature circulates in the circuit.
- B. If a system has other heating source inside that is out the control of heat pump (e.g. Solar system), as the actual water temperature may exceed the set temperature of heat pump, a mixing valve is also needed to ensure the circuit gets water with correct temperature circulates in the circuit.

2. Heating/Cooling Circuit 2 (Zone 2)



Heating/Cooling Circuit 2

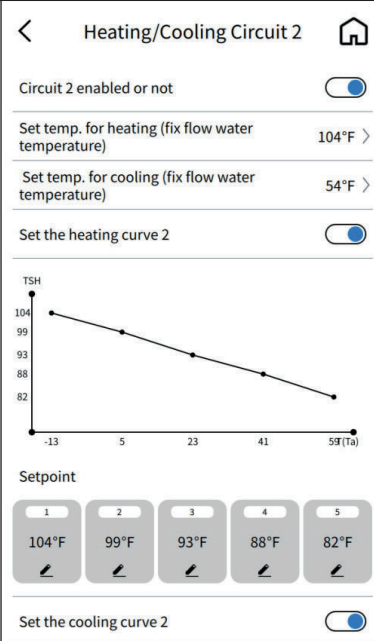

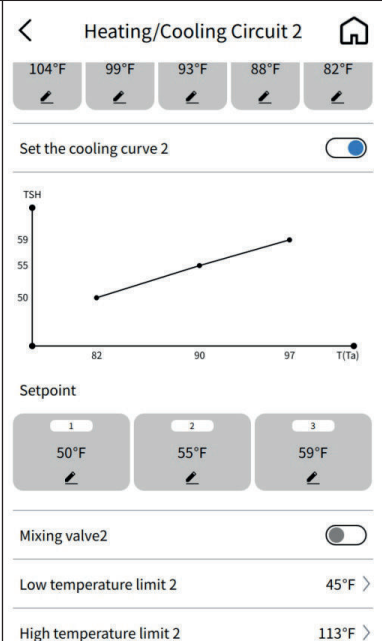

Heating/Cooling Circuit 2 (Zone 2)			
	PARAMETER	RANGE	DEFAULT
2.01	Circuit 2 enabled or not	ON - OFF	OFF
Set whether the system has the second circuit or not. "Heating/Cooling Circuit 2" is allowed to operate when the house has two circuits.			
2.02	Set temp. for heating (fix flow water temperature)	2 - 9 (°F)	4°F
2.03	Set temp. for cooling (fix flow water temperature)	2 - 9 (°F)	4°F
Set whether heating curve 2 function is needed or not. If heating curve function is off, set this parameter to off, then you can set a fixed water set temperature under heating mode via parameter "Set Temp For Heating". If Heating Curve 2 is on, user can set a this parameter to create a suitable curve which fits his house. The horizontal coordinate is the ambient temperature and the vertical coordinate is the water temperature. When the curve function is turned on, the system will use the water temperature corresponding to the current ambient temperature in the curve as the set temperature for heating in circuit 1. You can modify the values to get an ideal curve.			
2.04	Set the heating curve 2	[ON-OFF]	
Set whether heating curve 2 function is needed or not. If heating curve function is off, set this parameter to off, then you can set a fixed water set temperature under heating mode via parameter "Set Temp For Heating". If Heating Curve 2 is on, user can set a this parameter to create a suitable curve which fits his house. The horizontal coordinate is the ambient temperature and the vertical coordinate is the water temperature. When the curve function is turned on, the system will use the water temperature corresponding to the current ambient temperature in the curve as the set temperature for heating in circuit 1. You can modify the values to get an ideal curve.			
2.05	Set the cooling curve 2	[ON-OFF]	
Same as setting in 2.04, just modify heating to cooling mode.			
2.06	Mixing valve 2	[ON-OFF]	
Set whether circuit 2 has a mixing valve connected or not.			

Heating/Cooling Circuit 2 (Zone 2)			
	PARAMETER	RANGE	DEFAULT
2.07	Low temperature limit 2	41 - 77 (°F)	45°F
2.08	High temperature limit 2	68 - 140 (°F)	131°F
These two parameters are used by the installer level, to set the set temperature range for circuit 2 for safety purpose.			
Table 10 - Heating/Cooling Circuit 2 (Zone 2) parameters			

3. Sanitary Hot Water



Sanitary hot water

Sanitary hot water

- Setpoint DHW 140°F >
- DHW restart ΔT setting 9°F >
- Heating/DHW shifting priority
- Ambient temp. to start shifting priority mode 32°F >
- Min. working time for DHW (minutes) 33min >
- Max. working time for heating (minutes) 94min >
- Allowable temp drift in heating 9°F >
- DHW backup heater for shifting priority
- High temperature limit (DHW) 140°F >

Domestic Hot Water			
	PARAMETER	RANGE	DEFAULT
3.01	Setpoint DHW	68- par. 3.09 (°F)	140°F
Set temperature for sanitary hot water.			
3.02	DHW restart ΔT setting	4-27 (°F)	41°F
Heat pump unit will restart to work for sanitary hot water, after temperature drops below Tset-ΔT here.			
3.03	Heating/DHW shifting priority	ON - OFF	OFF
Turn ON/OFF this function. Air to water heat pump is an equipment that absorbs heat from surrounding air, and transfers it to water. The lower the ambient temperature is, the less heat the unit absorbs, so performance of heat pump will reduce if ambient temperature drops, it takes longer time to heat up the sanitary hot water. At the same time, the lower ambient temperature it is, the more heating demand for the house. If the unit does not provide enough heat while it is working for hot water, the temperature inside the house may drop too much. So parameters 3.03~3.05 try to balance the demand for sanitary hot water and heating. When this function is ON, AH - Auxiliary Heater or HWTBH - Hot Water Tank Back-up Heater or both, depending on their priority, will work individually or together to enhance heat pump's capacity in hot water mode to heat up the water as soon as possible.			

Domestic Hot Water			
	PARAMETER	RANGE	DEFAULT
3.04	Below a ambient temp. to start shifting priority mode	5 - 68 (°F)	34°F
Set an ambient temperature which below it, this function starts to work.			
3.05	Min. working time for DHW (minutes)	10 - 60 (min)	20 min
Under shifting priority mode, set the minimum working period for sanitary hot water mode.			
3.06	Max.working time for heating (minutes)	30 - 180 (min)	30 min
Under shifting priority mode, if system switch from DHW to heating, this value depend the maximum working period for heating mode.			
3.07	Allowable temp drift in heating	5 - 18 (°F)	9°F
Set allowable temperature drift in heating mode.			
3.08	DHW backup heater for shifting priority	ON - OFF	OFF
Working mode of HWTBH - Hot Water Tank Back-up Heater in this function. If it is set ON, even if heat pump switch to house heating, HWTBH will keep on working to help the unit heat up hot water as soon as possible.			
3.09	High temperature limit (DHW)	68 - 140 (°F)	140°F
This parameter is used by the installer level, to set the temperature range for DHW for safety purpose.			

Table 11 - Sanitary Hot Water parameters

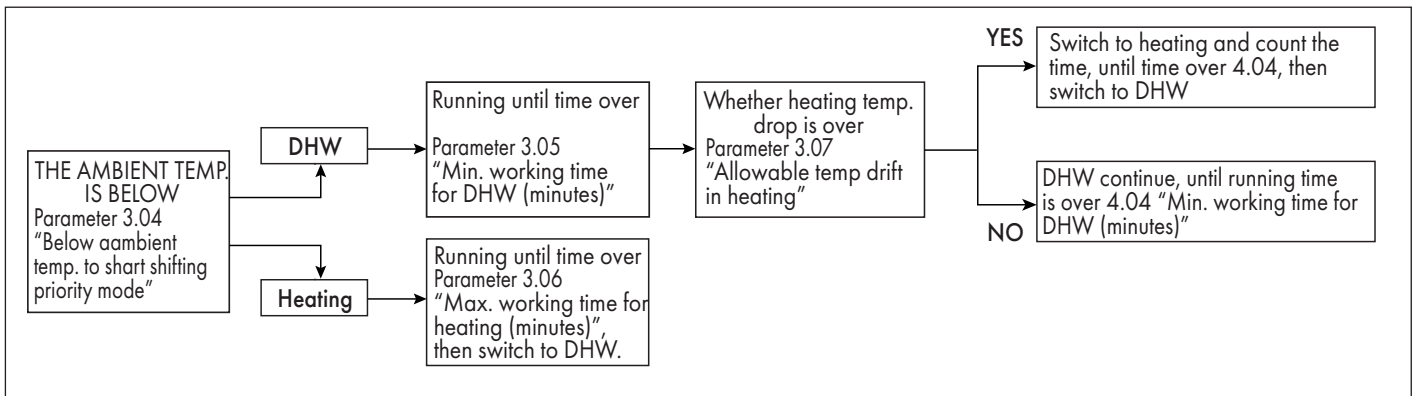

4. Working Mode



Working Mode

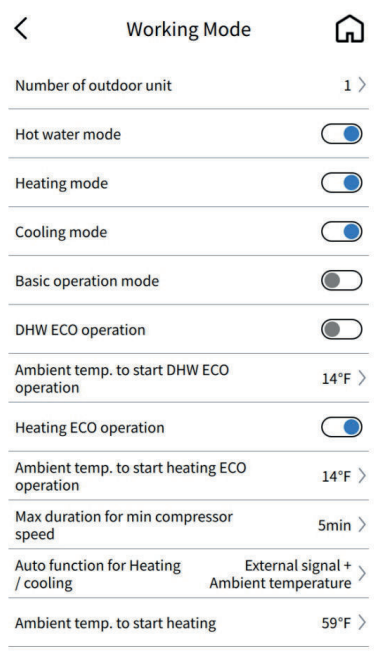

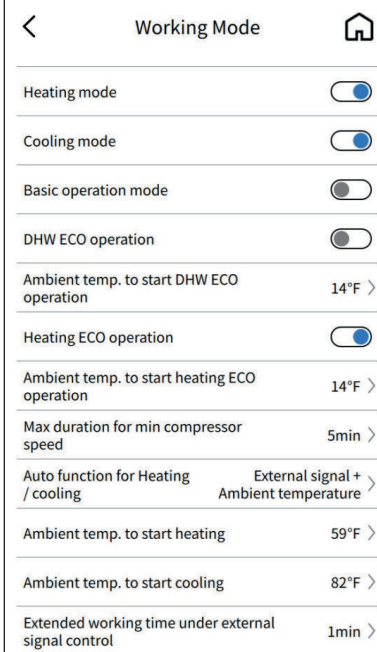

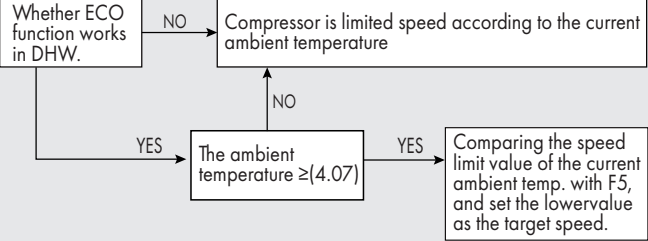
Working Mode			
	PARAMETER	RANGE	DEFAULT
4.01	Number of outdoor unit		1
NOT EDITABLE for this version.			
4.02	Hot water mode	ON - OFF	ON
Set whether the system has DHW circuit or not. When unit works in Sanitary Water mode, 3-way valve leads water to HWT - Hot water tank automatically.			
4.03	Heating	ON - OFF	ON
Set whether the system has water circuit for house heating or not. When unit works in heating mode, 3-way valve leads water to heating circuit automatically.			
4.04	Cooling	ON - OFF	OFF
Set whether the system has water circuit for house cooling or not. When unit works in cooling mode, 3-way valve leads water to cooling circuit automatically.			
4.05	Basic operation mode	ON - OFF	OFF
Set the basic operation mode, as "Water Temperature Control" (by default) or "Room Temperature Control". Note: If set to "Room Temperature Control", heating curve function will not be activated.			
4.06	DHW ECO operation	ON - OFF	ON
When ambient temperature is not too low and the DHW demand is not too urgent, the output capacity of the heat pump can be appropriately reduced to obtain better energy efficiency by reducing the compressor frequency in DHW mode. <i>This function is set by the installer level.</i>			
4.07	Ambient temp. to start DHW ECO operation	-4 - 109 (°F)	14°F
If ambient temp. is higher than this value, compressor will check current frequency with F5, and then work with a lower frequency. The logic is:			
 <pre> graph TD A[Whether ECO function works in DHW.] -- NO --> B[Compressor is limited speed according to the current ambient temperature] A -- YES --> C[The ambient temperature ≥ (4.07)] C -- YES --> D[Comparing the speed limit value of the current ambient temp. with F5, and set the low value as the target speed.] C -- NO --> B </pre>			

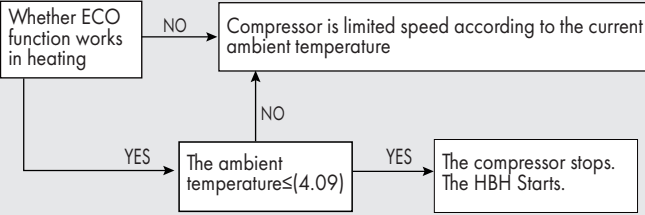
Working Mode			
	PARAMETER	RANGE	DEFAULT
4.08	Heating ECO operation	ON - OFF	OFF
If ambient temperature is too low, and this function is activated, the compressor will stop and HBH will work.			
4.09	Ambient temp. to start heating ECO operation	-4 - 109 (°F)	14°F
Set the start ambient temperature of Heating ECO function. If the ambient temperature is lower than this value, the heat pump will shutdown and the auxiliary heater (HBH) starts. The logic is:			
 <pre> graph TD A[Whether ECO function works in heating] -- NO --> B[Compressor is limited speed according to the current ambient temperature] A -- YES --> C[The ambient temperature ≤ (4.09)] C -- YES --> D[The compressor stops. The HBH Starts.] C -- NO --> B </pre>			
4.10	Max duration for min. compressor speed	5-180 (min)	
When unit output is higher than demand, compressor speed reduces. If compressor has continuously worked at minimum speed F1 over this setting time, unit stops.			
4.11	Auto function for Heating / cooling	Ambient Temp External Signal + Amb Temp External Signal	
This function allows the unit to start cooling or heating operations automatically, according to:			
<ol style="list-style-type: none"> If setting="Ambient Temp", system will automatically choose cooling or heating operation based on the outdoor ambient temperature, compared with parameter set in "Outdoor temp. to start heating" and "Outdoor temp. to start cooling". If setting="External Signal Control", an external room sensor or central control system in the building can control the cooling or heating requirements by connecting it to the respective signal ports. If setting="Ambient Temp.+External Signal Control", unit will take both the ambient temperature and external signal into consideration for cooling or heating mode selection. 			
Note: If this parameter is set to OFF, then make sure that parameter "Heating Water Circuit" and "Cooling Water Circuit" are not set to ON simultaneously, as the system can not determine actual requirement, due to mode conflict. Also if "External Signal Control" is used to take control, please ensure that the external signal will not be activated at the cooling and heating ports at the same time.			

Part 5 - Controls

Working Mode			
	PARAMETER	RANGE	DEFAULT
4.12	Ambient temp. to start heating	14 - 77 (°F)	
For example, set value as 59°F, when the system recognizes there is a demand the system will start heating operation automatically when ambient temperature is lower than 59°F.			
4.13	Ambient temp. to start cooling	68 - 127 (°F)	
For example, set value as 82°F, when the system recognizes there is a demand the system will start heating operation automatically when ambient temperature is higher than 82°F.			

Working Mode			
	PARAMETER	RANGE	DEFAULT
4.14	Extended working time under external signal control	1 - 60 (min)	
When the external signal controls heating and cooling operations of the unit, this setting is the heat pump OFF delay time after OFF signal. The unit keep running for some time to ensure overall room temp. instead of only the thermostat detecting temp. reaches the set value.			

Table 12 - Working Mode parameters

5. System Settings



System Settings

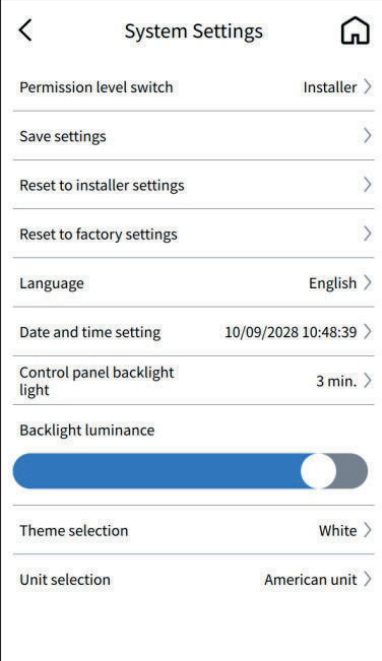

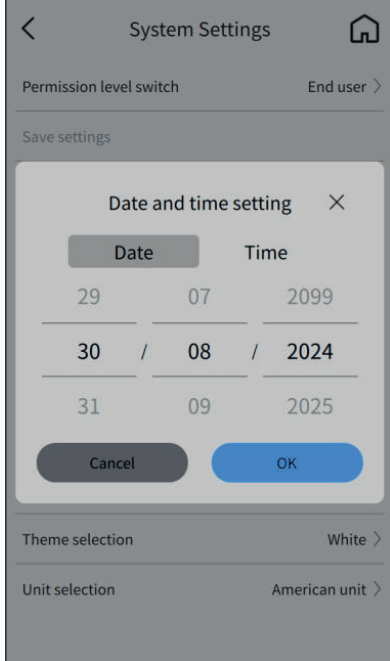

System settings			
	PARAMETER	RANGE	DEFAULT
5.01	Permission level	user installer	
For safety purposes, some parameters can only be adjusted under installer level. The permission level can be changed in this menu. A password for installer level is needed. The password to change to "installer" from "user" is 87654321. This will toggle from user to installer. However, if the permission level is set to "installer" the control will automatically switch back to user after 5 minutes of non-usage. This is to protect non-installers from having access to parameters that they are not permitted to access.			
5.02	Save Settings	> Save settings?	
To save the current settings as "Installer Settings", so the user can load the saved settings into the system if needed.			
5.03	Reset to installer settings	> Reset to installer settings?	
Loaded the saved "Installer Settings".			
5.04	Reset to factory settings	> Reset to factory settings?	
Reset the whole system back to factory default settings. Note: Saved "Installer Settings" will be cleared.			
5.05	Language	English --	English
Set system language.			

System settings			
	PARAMETER	RANGE	DEFAULT
5.06	Date and time setting		>
Set system date and time.			
5.07	Controller panel backlight setting	3 or 5 or 10 (min.)	
Set the screen backlight or rest time.			
5.08	Backlight luminance		
Set the screen brightness.			
5.09	Theme selection	Black White Blue	
Select color theme for the interfaces.			
5.10	Unit selection	International unit American unit	
Select "International unit" or "American unit" as the unit used by the system.			
		International unit	American unit
1. Temperature unit		°C	°F
6. Pressure unit		bar	psi

Table 13 - System settings parameters

6. Timer

The timer function allows the user to set certain days and times that will allow the unit to operate in the individual modes (if applicable) at a given water temperature. If the system recognizes a demand during these times, the system will not operate as it's outside of the allowable times set in the menu.

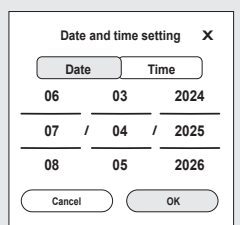
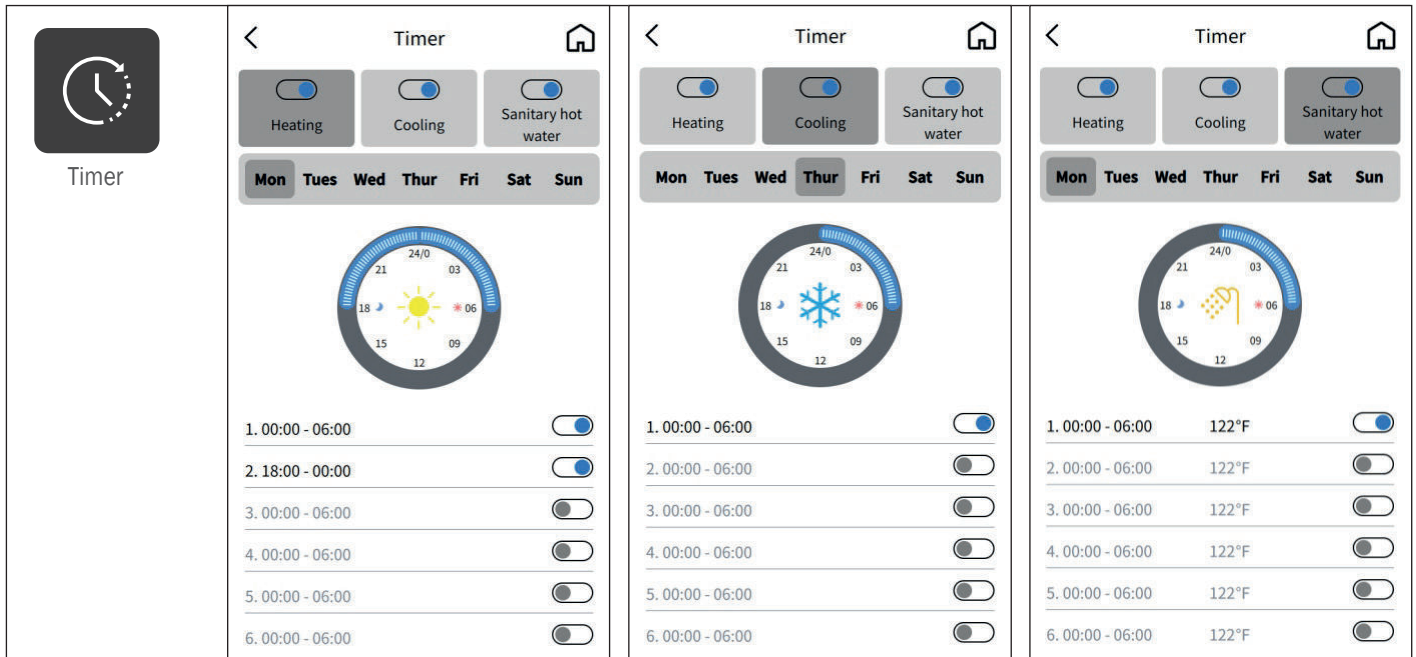

Set the timer for heating/cooling/DHW separately. And you can select the day, the temperature in each mode.

7. Anti-Legionella

Anti-Legionella function protects the system during non operational times to prevent against stagnant water sitting in the system. This can be toggled on or off.

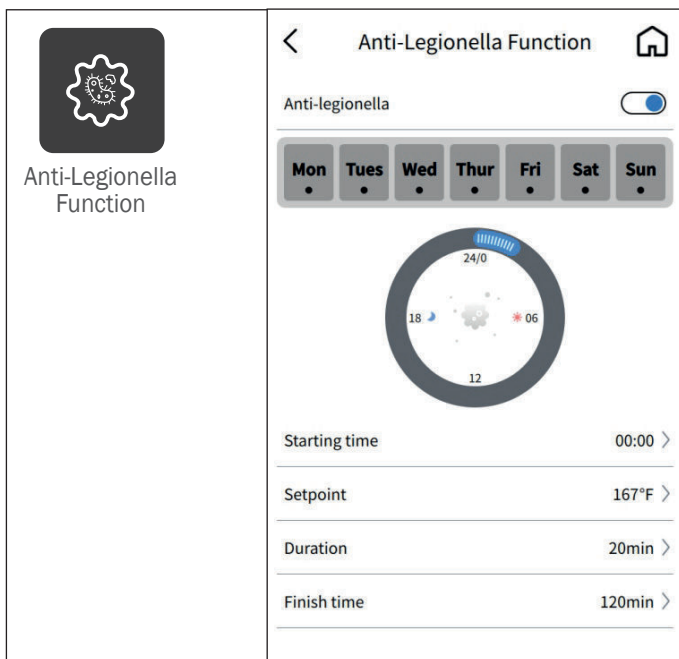

Anti-Legionella			
	PARAMETER	RANGE	DEFAULT
7.01	Anti-legionella program	ON - OFF	
Turn ON/OFF Anti-Legionella function.			
7.02	Starting time		00:00
Set the start time for the Anti-Legionella function to run, which can only be set when 7.01 is turned on. Select weekday(s) for the start of Anti-Legionella operation, select which clock in everyday.			
7.03	Setpoint	140 - 167 (°F)	
Set the target sanitary hot water temperature for sterilization. Please refers to the local regulation for the correct setting of this temperature.			
7.04	Duration	5 - 60 (min)	
Set for how long the unit should try to keep this set high temperature, to ensure the bacteria in the shower water tank can be killed.			
7.05	Finish time	10 - 240 (min)	
Set an ending time for this Sterilization function, even it is not finished successfully. This time should be longer than what it is set in parameter 7.04.			
Table 14 - Anti-Legionella parameters			

When the Anti-Legionella function starts and is in the setting timer of parameter 7.02, the unit will heat up DHW tank to the 7.03 temperature setpoint. When the water outlet temperature (TUO) reaches the unit's max. water outlet temperature (TUO_{max}), the compressor will stop, then the auxiliary heater (AH) and the DHW backup heater (HWTBH) will start to heat up the DHW tank until the DHW temperature reaches the sterilization temperature. Then system will counting the time for sterilization, if it is over "duration" that you set, then exit sterilization. When the sterilization function running time is greater than the maximum running time of 120 minutes, also exit sterilization, waiting for the next opening. **Note:** Please always refers to local regulation for a correct usage of this function.

8. Sleep and Quiet mode

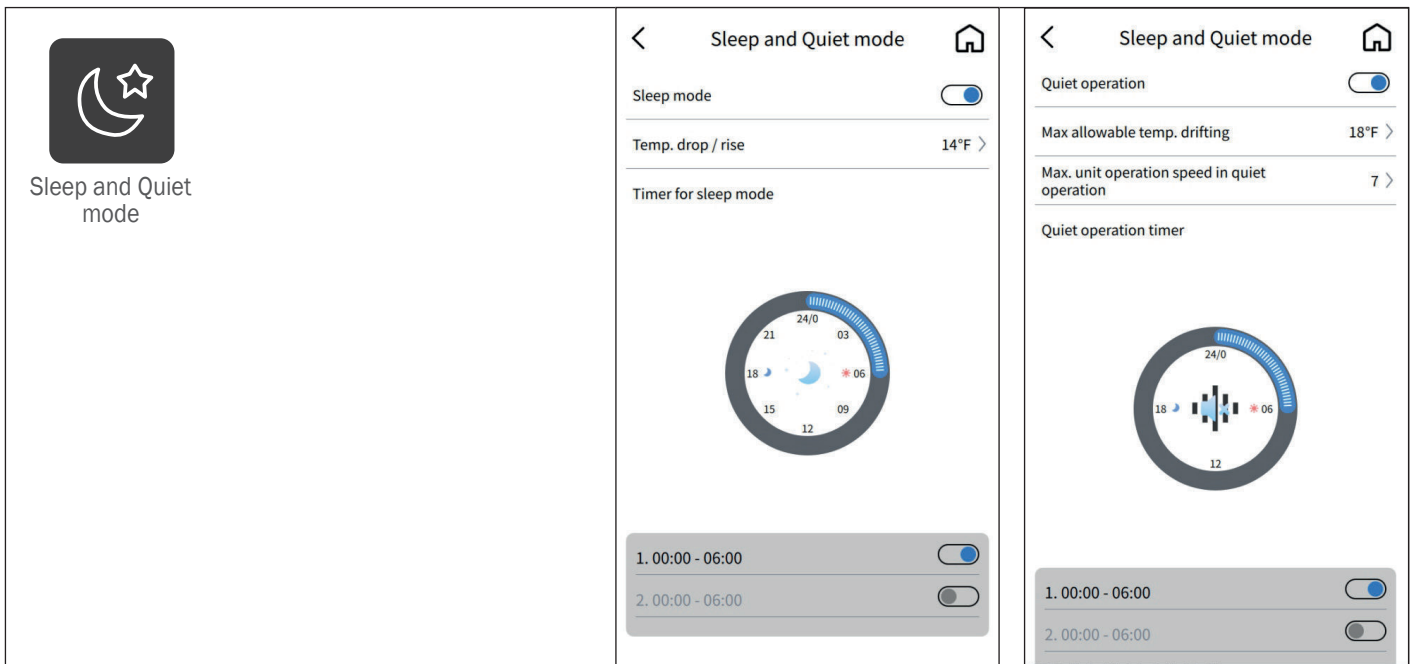

Sleep and quiet mode will be used during times when the demand for the unit to operate will be lower.
 For example- If you want to make sure the unit runs most efficiently at night time or during sleeping hours, you will turn this function on.
 Please note. If sleep and quiet mode are operational and max compressor speed is limited, then the unit will not perform to full capacity.

Sleep and quiet mode			
	PARAMETER	RANGE	DEFAULT
8.01	Sleep mode	ON - OFF	
Turn ON/OFF Sleep operation mode. When the house heating demand can be lower, like sleep period or working time, a lower set temp. can be set here for better system consumption.			
8.02	Temp. drop/rise	4 - 18 (°F)	
Set temperature drop (in heating) or increase (in cooling) based on standard set temperature during sleep mode.			
8.03	Timer for sleep mode		
Set a timer for Sleep mode. Different time periods for every day in a week can be set.			
8.04	Quiet operation	ON - OFF	
Turn ON/OFF quiet operation mode. After activating this function and setting the time period for quiet operation, unit will reduce its noise level. Note: Unitefficiency in Quiet Operation mode will be lower than standard working mode.			
8.05	Max allowable temp. drifting	2 - 54 (°F)	
When the unit works in quiet mode, the output may drop because both fan and compressor may need to work in lower speed. So temperature in the system may drop (in heating) or increase (in cooling) due to the lower output. The data set here is a temperature difference between set temperature and bearable temperature. If current temperature is lower than Ts deduct this value, unit will exit this Quiet Operation, to ensure a comfortable house temperature.			
8.06	Max. unit operation speed in quiet operation	3 - 7	
Set the max. compressor frequency limitation under quiet mode.			
8.07	Quiet operation timer		
Set a working time period for Quiet Operation. Different time periods for every day in a week can be set.			

Table 15 - Sleep and quiet mode parameters

9. Vacation

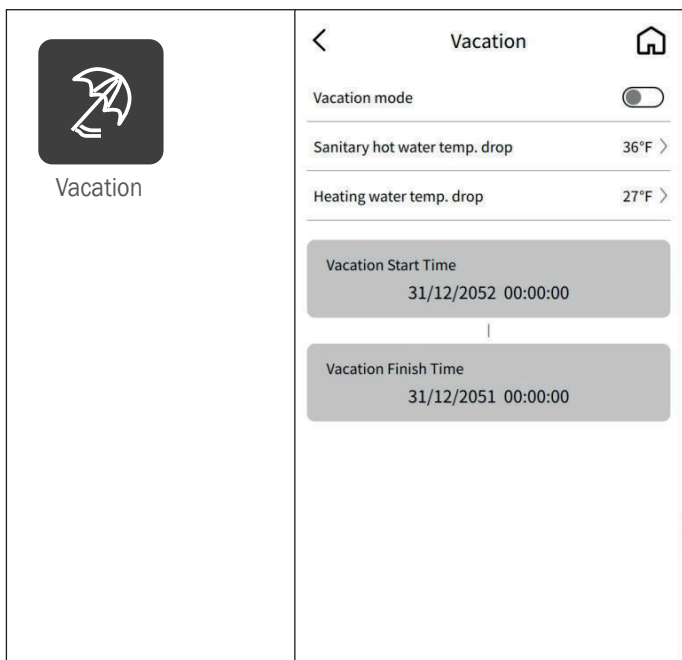

Activating “vacation mode” allows the unit to not operate as frequently as if the user is home. If set properly, this will save energy while the user is away.

Vacation			
	PARAMETER	RANGE	DEFAULT
9.01	Vacation mode	ON - OFF	
Turn ON/OFF Vacation mode.			
9.02	Sanitary hot water temp.drop	2 - 90 (°F)	
Set an allowable temperature drop for sanitary hot water based on standard DHW set value during the set time for vacation mode.			
9.03	Heating water temp.drop	2 - 90 (°F)	
Set an allowable temperature drop for heating based on standard DHW set value during the set time for vacation mode.			
9.04	Vacation start time		
Set the time and date that vacation starts.			
9.05	Vacation finish time		
Set the time and date that vacation finishes. After this time, the setting temperature of sanitary hot water and heating will restore.			

Table 16 - Vacation parameters

10. Fault Information Query

In the fault information query menu, the user can see current faults (if any) and historical faults from the system. The faults can also be cleared, however, it’s not recommended to clear the faults as they could be useful for future troubleshooting if necessary. If there is a fault, the user/installer can push the individual faults which will give a few suggested items to check in order to clear the fault or repair the fault. If those items do not work, please refer to the troubleshooting section in this document, or contact technical support.

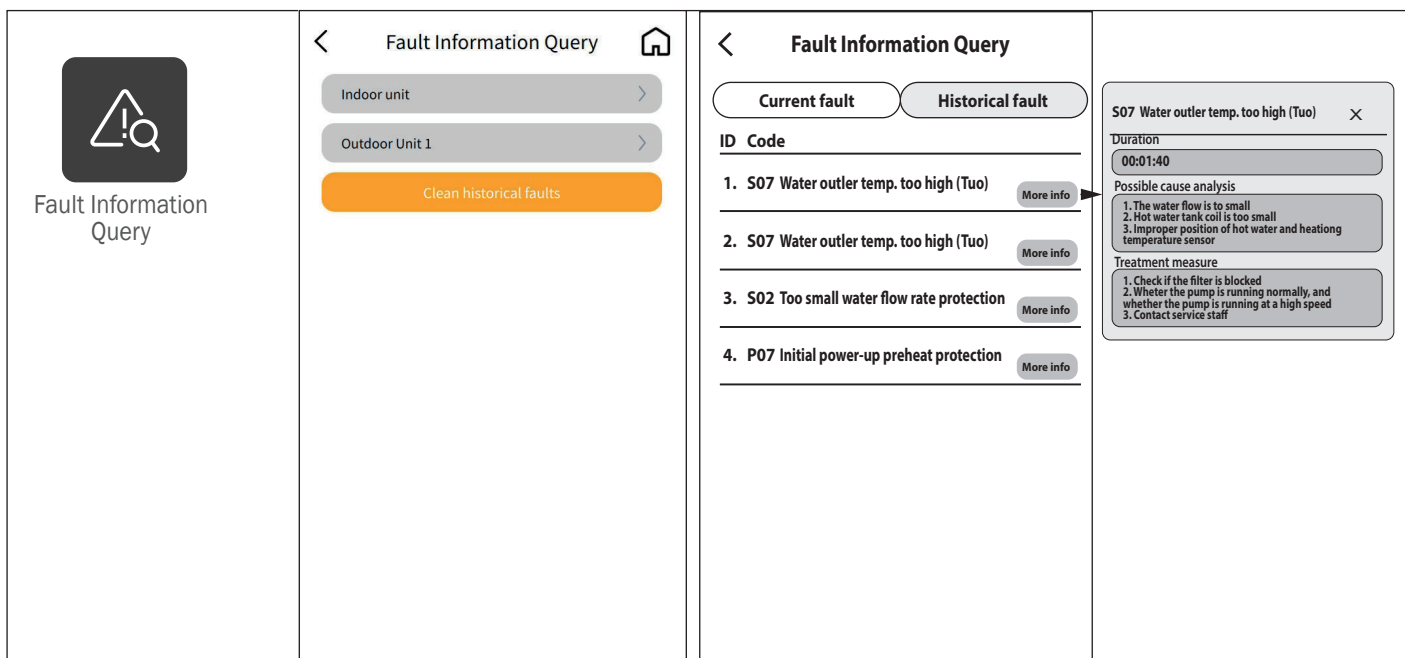

In 1st page, select unit(s) which reports error code.
The system supports multi-unit cascade.
In 2nd page, check current fault or historical fault of the unit.
Note: Only after entering the installation level, then the historical fault can be checked and cleared.

11. Parameters Overview

These screens can also be seen through the homepage shortcut by pressing the "ambient temperature" on the left hand side.

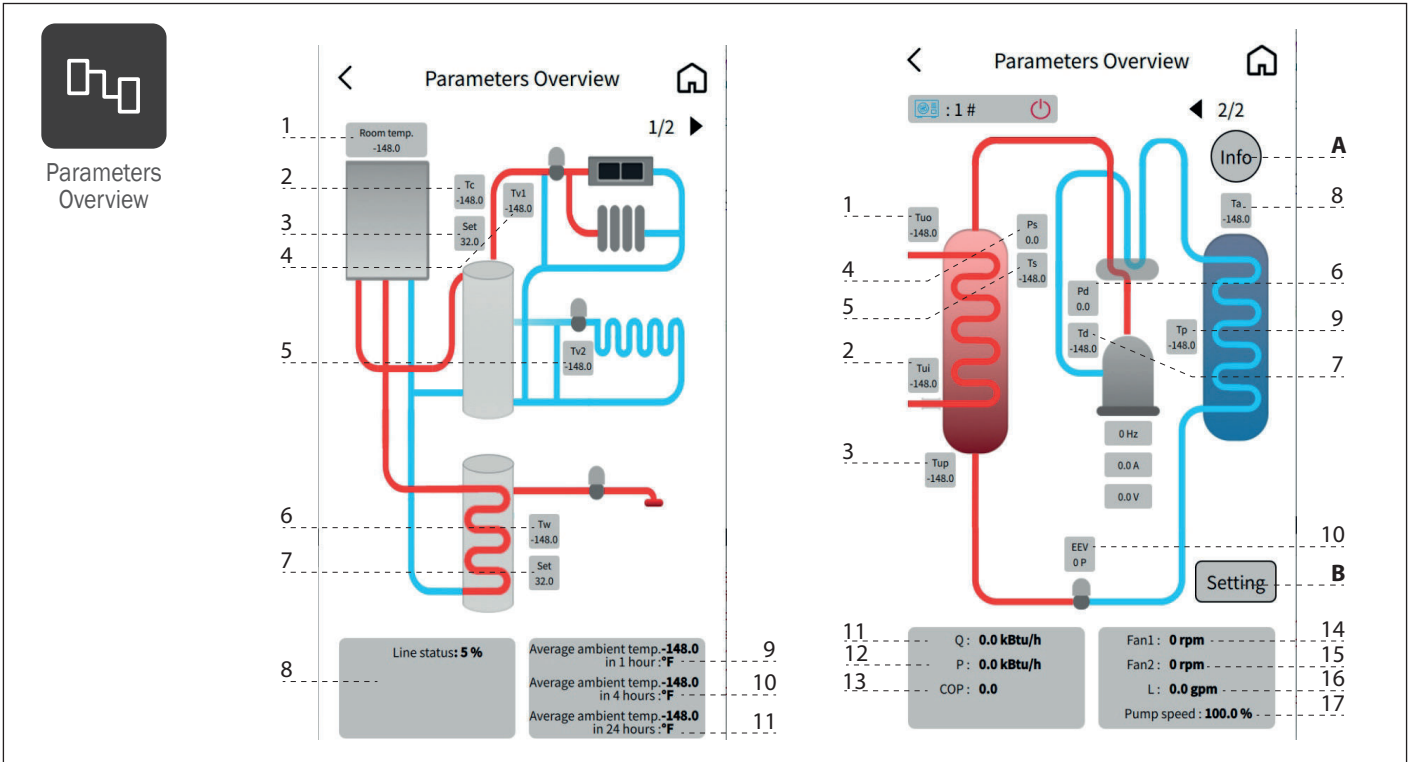

Parameters overview		
	PARAMETER	VALUE
11.01 (1/2)	1 - Room temp.	
	2 - Tc: Cooling/Heating water temp.	
	3 - Set: The heating/cooling temperature is currently set	
	4 - Tv1: Mixing temp. 1	
	5 - Tv2: Mixing temp. 2	
	6 - Tw: Sanitary hot water temp.	
	7 - Set: Current set temp. of hot water	
	8 - Line status: Communication success rate	
	9 - Average ambient temp. in 1 hour	
	10 - Average ambient temp. in 4 hour	
	11 - Average ambient temp. in 24 hour	
11.02 (2/2)	1 - Tuo: Heat exchanger water outlet temp.	
	2 - Tui: Heat exchanger water return temp.	
	3 - Tup: Internalcoil temp.	
	4 - Ps: Low pressure	
	5 - Ts: Compressor suction temp.	
	6 - Pd: High pressure	
	7 - Td: Compressor discharge temp.	
	8 - Ta: Ambient temp.	
	9 - Tp: Outdoor coil temp.	
	10 - EEV: EEV opening	
	11 - Q: Current capacity of heat pump	
	12 - P: Current power of heat pump	
	13 - COP: Current COP of heat pump(Q/P)	
	14 - Fan1: Fan speed 1	
	15 - Fan2: Fan speed 2	
	16 - L: Water discharge	
	17 - Pump speed	

Table 17 - Parameters overview

A Info >

B Setting >

YES

YES

YES

YES

NO

Fault Information Query

Current fault | Historical fault

ID | Fault Code

Device Configuration 1#

Hot water mode

Heating mode

Cooling mode

Is the three-way valve configured

Whether with auxiliary electric heater

P1 Heating P1 Cooling P1 High temperature

P2 Heating P2 Cooling P2 High temperature

12. Water Pump Settings

Water pump settings			
	PARAMETER	RANGE	DEFAULT
12.01	Circulation pump P0 type	AC Pump PWM Pump	PWM Pump
<p>This parameter will set the type of circulation pump P0. The P0 pump can be installed in the field or internal to the system (for hydrobox only) and serves the main loop between the outdoor unit and indoor products (tanks). If set to AC then the unit will output voltage to turn on the AC pump when a demand is recognized. If set to "PWM" then the unit will output a PWM signal (see wiring digram) and expect a PWM feedback from the pump.</p>			
12.02	Working mode of circulation pump P0	1 - 3	
<p>To set the working mode of circulation pump for cooling/heating operation inside the unit (P0). P0 can work as the following settings:</p> <ol style="list-style-type: none"> Interval working mode. In this setting, P0 stops after compressor stops, but runs for "13.04 setpoint". ON constantly. P0 will work constantly even if compressor stops after reaching the set temperature. OFF with compressor. It means P0 stops after compressor stops. 			
12.03	Pump Off interval for P0	5 - 60 (min)	6 min
12.04	Pump On time for P0	1 - 10 (min)	1 min
<p>If unit circulation pump P0 working mode is set to "Interval working mode", that means circulation pump stops after compressor stops. After it stops, it will run for "ON interval" time after every "OFF interval" minute stops.</p>			
12.05	Buffer tank	ON - OFF	ON
Set if system install buffer tank or not.			

Water pump settings			
	PARAMETER	RANGE	DEFAULT
12.06	Water Pump Settings		
<p>These parameters are used for setting the working of external circulation pump P1 and P2, for heating/cooling circuit 1, and heating/cooling circuit 2. If P1 activated to high temperature, means during "Dual heating circuits" is set, P1 connects to higher water temp system. P2 works in the same way.</p>			
12.07	Water flow rate for P0	set max speed	
<p>These parameters are used for controlling the speed of P0. Select circuit</p> <p>Set Max Speed (Ex. Heating circuit)</p>			
12.08	Airpurge-internal water pump P0	ON - OFF	
This function is used for automatically purging the air in the heating & cooling circuit.			
12.09	Air purge-DHW water pump P3	ON - OFF	
<p>This function is used for automatically purging the air in the DHW circuit. In order to purge the air in the DHW circuit starting from 3way-valve in CH position, technician can manually switch 3way-valve from CH to DHW position and activate air purge cycle setting par.13.08 Air purge-internal water pump P0 to ON. Note: Timing on the air purge function is to let the pump purge the air for 30mins.</p>			

Table 18 - Water pump parameters

NOTICE

“With/without Buffer Tank”: Set whether it has a buffer tank between heat pump unit and distribution system or not.

“P1 for Heating Operation” means circuit pump for circuit 1 should work for heating operation.

“P1 for Cooling Operation” means circuit pump for circuit 1 should work for cooling operation.

“P2 for Heating Operation” means circuit pump for circuit 2 should work for heating operation.

“P2 for Cooling Operation” means circuit pump for circuit 2 should work for cooling operation.

If “without buffer tank” is set, both P1 (circulation pump for circuit 1) and P2 (circulation pump for circuit 2) will only work when compressor is working in the same mode as the pump is set to.

For example,

if P1 is set to “P1 for Heating Operation”, P1 will be turned ON only when compressor is working in heating mode.

If both “P1 for Heating Operation” and “P1 for Cooling Operation” are both selected, P1 will be turned ON when compressor is working in both heating and cooling mode.

When heat pump switches to DHW mode or stops after get the set temperature for heating or cooling, pump stops.

If “with buffer tank” is set, both P1 (circulation pump for circuit 1) and P2 (circulation pump for circuit 2) will work once the distribution system has the heating or cooling demand, as per the pump setting, and obeys following rules:

- Actual temperature in buffer tank detected via $T_c \geq 68^\circ\text{F}$ in heating. Only 68°F and above can be useful for distribution system in heating operation.
- Actual temperature in buffer tank detected via $T_c \leq 73^\circ\text{F}$ in cooling. Only 73°F and below can be useful for distribution system in cooling operation.

For example,

if P1 is set to “P1 for Heating Operation”, P1 will start to work as long as the system has heating demands and T_c reading is no lower than 68°F , even if the unit is working in DHW mode or stops after get the set temperature.

“Working of P1(2) with High Demanding Signal” means whether P1(P2) should stop if signal for “high demanding” is off. For detailed meaning of “High Demanding Signal”, please refers to part “D” of “Terminal Block 4” of chapter “2.5.1”, “High demanding distribution system switch”.

13. Eletrical & back-up heater settings



Electrical & back-up heater settings

AH Auxiliary Heater
HBH Heating Back-up Heater
HWTBH Hot Water Back-up Heater

Electrical & back-up heater settings

Heating Back-up Heater(HBH)

Backup source start accumulating value (HBH) 240 >

Priority for backup heating sources (HBH)

HBH > AH (Heat Backup Heater > Auxiliary Heater)

HBH < AH (Heat Backup Heater < Auxiliary Heater)

Hot Water Back-up Heater(HWTBH)

Water temperature rise reading interval (HWTBH) 1min >

Priority for backup heating sources (HWTBH)

HWTBH > AH (Hot Water Tank Backup Heater > Auxiliary Heater)

HWTBH < AH (Hot Water Tank Backup Heater > Auxiliary Heater)

Emergency operation

Disactivated auxiliary heater (AH)?

If AH controlled by ambient temp.

Ambient temp. for AH start 59°F >

Electrical & back-up heater settings

Priority for backup heating sources (HBH)

HBH > AH (Heat Backup Heater > Auxiliary Heater)

HBH < AH (Heat Backup Heater < Auxiliary Heater)

Hot Water Back-up Heater(HWTBH)

Water temperature rise reading interval (HWTBH) 1min >

Priority for backup heating sources (HWTBH)

HWTBH > AH (Hot Water Tank Backup Heater > Auxiliary Heater)

HWTBH < AH (Hot Water Tank Backup Heater > Auxiliary Heater)

Emergency operation

Disactivated auxiliary heater (AH)?

If AH controlled by ambient temp.

Ambient temp. for AH start 59°F >

Eletrical & back-up heater settings			
	PARAMETER	RANGE	DEFAULT
13.01	Heating Back-up Heater (HBH)	ON - OFF	OFF
Set whether the system has HBH(Heating Back-up Heater) .			
13.02	Backup source start accumulating value (HBH)		
Accumulated value calculated between operation time and set temp. to start the HBH. This is for adjusting how fast Backup Heating Sources for heating operation will be turned ON if heat pump unit can't provide enough power. The bigger the value is set, longer time it takes to start the HBH.			
13.03	Priority for backup heating sources (HBH)	HBH > AH HBH < AH	
Set the priority of HBH compared with unit AH (Auxiliary Electric Heater inside the indoor unit). When unit works in heating, if heat pump unit can't provide enough power, it will turn on AH or HBH (which set to have the higher priority) automatically. If after AH or HBH activated, that the total output power is still not enough, unit will turn on the lower priority backup heating source also.			
13.04	Hot Water Back-up Heater (HWTBH)	[ON-OFF]	OFF
Set whether the system has HWTBH(Hot Water Tank Back-up Heater).			
13.05	Water temperature rise reading interval (HWTBH)		
Time interval for checking the temperature increase when unit works in DHW mode. If within this interval, DHW temperature can not increase for 2°F, unit will activate HWTBH.			
13.06	Priority for backup heating sources (HWTBH)	HWTBH > AH HWTBH < AH	
Set the priority of HWTBH compared with unitAH(Auxiliary Electric Heater inside the indoor unit). When unit works in hot water, if heat pump unit can't provide enough power, it will turn on AH or HWTBH (which set to have the higher priority) automatically. If after AH or HWTBH is working, that the total output power is still not big enough, unit will turn on the lower priority Backup Heating Source also.			

Eletrical & back-up heater settings			
	PARAMETER	RANGE	DEFAULT
13.07	Emergency operation	ON - OFF	OFF
If the heat pump has a fault that is not allowing it to operate (for example: flow switch fault) then the system will automatically turn ON the back up heating system. Whether the unit should turn ON the back-up heating system automatically. Note: If this function is activated, customer should check the working status of heat pump unit occasionally, to ensure heat pump unit is functioning well. Note: As the Emergency Operation function currently stands, if the heat pump has a fault during a DHW cycle, the back up heating system will not be turned ON and system stays in DHW cycle with no available generators. In this situation, in order to allow system to restore a heating cycle, user can reset the fault of the heat pump doing a power off/on of the IDU and force heating service selecting heating operation mode from Main pag of the user menu (see section 5.1).			
13.08	Disactivated auxiliary heater (AH)	ON - OFF	OFF
This function sets whether auxiliary heater is disactivated, The premise of choosing this option is setting "Heating backup heater (HBH)"=on. After turning on this function, the unit will not activate AH in heating mode.			
13.09	If AH controlled by ambient temp.	ON -OFF	
This function sets whether auxiliary heater (AH) is controlled by ambient temperature.			
13.10	Ambient temp. for AH start	----- (°F)	
If setting "Block the Working of Auxiliary Heater (AH) according to Ambient Temp." is on, the auxiliary heater (AH) will only work when ambient temperature < setpoint 15.10 (HBH & HWTBH are still valid).			

Table 19 - Eletrical & back-up heater parameters

14. Other Settings

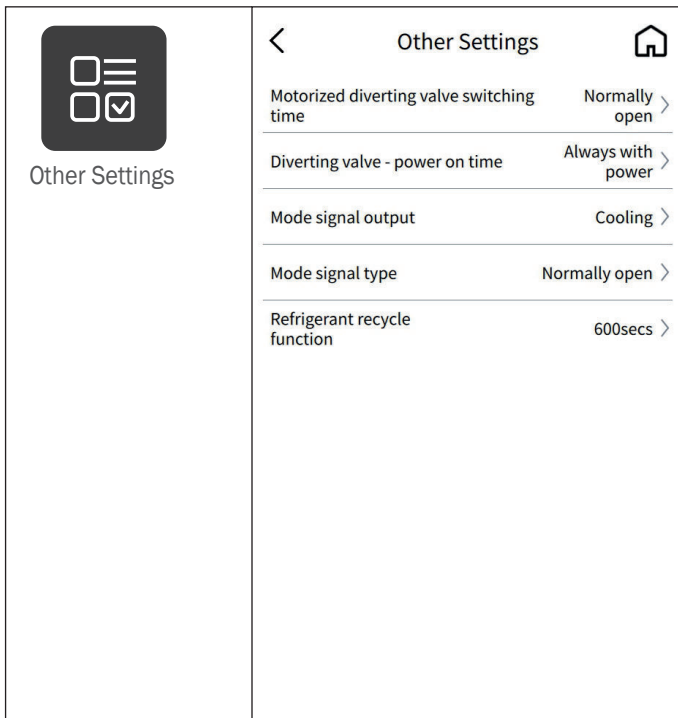

Other settings			
	PARAMETER	RANGE	DEFAULT
14.01	Motorized diverting valve switching time	[0-10]	6 min
Set the switching time of the motorized diverting valve depending on switching the water flow fully between DHW and Heating/Cooling circuit. Note: This parameter must comply with the motorized diverting valve. Otherwise, the unit may not be able to work due to not enough water flow rate.			
14.02	Diverting valve-power on time	[0-16]	0 - Always with Power
Set how long the motorized diverting valve should be powered, for switching the water flow fully between DHW and Heating/Cooling circuit.			
14.03	Mode signal output	OFF Heating Cooling	
This function is only used as the second signal output, and can be selected as cooling signal output or heating signal output, or invalid.			
14.04	Mode signal type	Normally close Normally open	
14.05	Refrigerant recycle function	Confirm activating the refrigerant recovery function?	

Table 20 - Other settings

15. Floor Curing

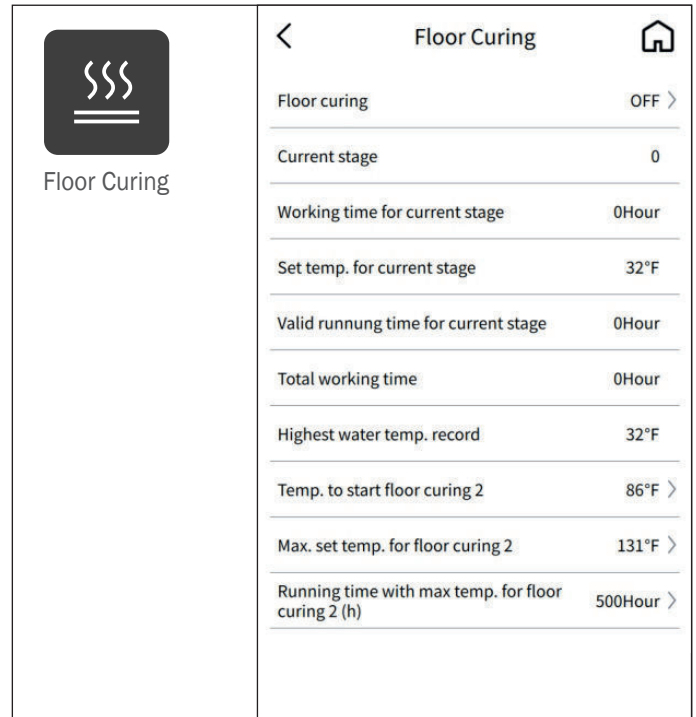

Floor curing			
	PARAMETER	RANGE	DEFAULT
15.01	Floor Curing	OFF FLOOR CURING 1 FLOOR CURING 2	OFF
Turn ON/OFF this function. If this is a new house with new floor heating system installation, you can use this function to heat the humidity during the pipes. By heating for several rounds, it can check if there is any weakness during the pipes, and fix it before moving in the house.			
15.02	Current stage		
Floor curing has several stages, it means currently which stage it is - visualization			
15.03	Working time for current stage		
Running time for this stage - visualization			
15.04	Set temp. for current stage		
Set temp. for this stage - visualization			
15.05	Valid running time for current stage		
This parameter is the valid running time during floor curing operation in current stage - visualization.			
15.06	Total working time		
This is a record for total running time of floor curing mode - visualization			
15.07	Highest water temp. record		
This is a record for highest water temp. during floor curing mode - visualization			
15.08	Temp. to start floor curing 2	77 - 131°F	
Floor curing 2 is another solution to heat the system.			
15.09	Max. set temp. for floor curing 2	77 - 131°F	
15.10	Running time with max temp. for floor curing 2 (h)	1 - 500 (hours)	144
Set the start temperature, max temperature and lasting time for second-stage of Floor Curing operation.			

Table 21 - Floor curing parameters

16. Software Upgrade

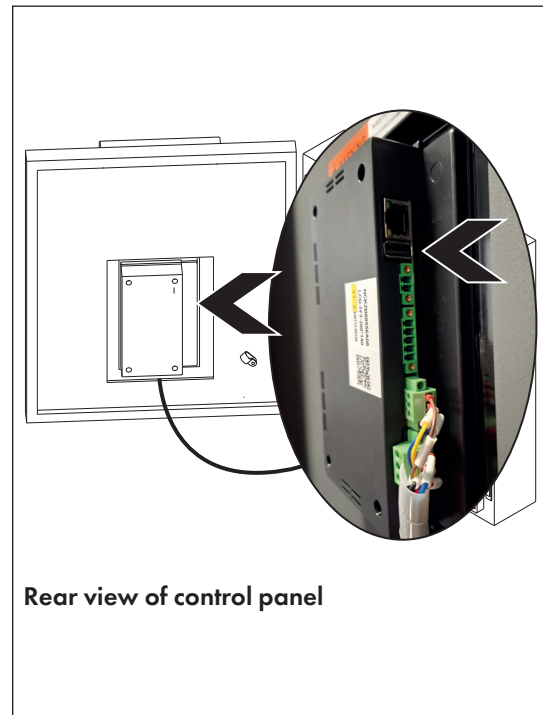
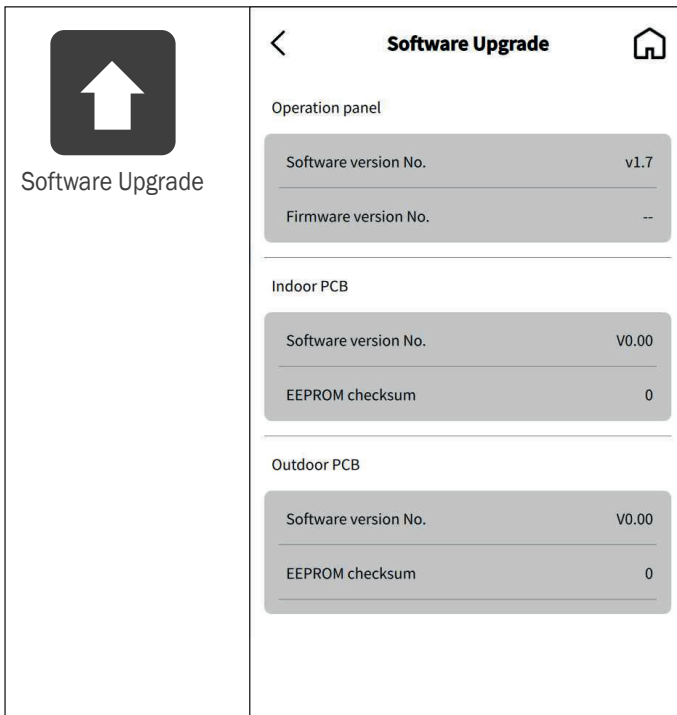

This software upgrade can be easily done by a USB flash drive. DO NOT update the software without contacting NTI technical support and ensuring the software being updated is out of date. Updating software without contacting NTI support will result in void of warranty.

17. Frost protection

The Verta Series units have built-in anti freeze protection to ensure the fluid does not freeze and burst pipes.

The unit has 2 different stages of frost protection:

- When the ambient temperature is lower than 43°F, enter the primary antifreeze, stop for N minutes, turn on for one minute, and circulate the pump.
- When the ambient temperature is lower than 39°F and the inlet water temperature is lower than 41°F, enter the secondary anti-freeze and start the heat pump operation.

When the inlet water temperature rises to 54°F, or the ambient temperature reaches 43°F, the secondary antifreeze is withdrawn, and the heat pump stops running.

When the ambient temperature is higher than 43°F, remove all antifreeze devices.

! WARNING

Use only freeze-protection fluids certified by fluid manufacturer as suitable for use with heat pumps, verified in the fluid manufacturer’s literature. Thoroughly clean and flush any system that has used glycol before installing the new heat pumps. Provide the heat pump owner with a material safety data sheet (MSDS) on the fluid used. The glycol content of the liquid must not exceed 48%, unless the “glycol” manufacturer specifies a different ratio. Glycol should be checked periodically to ensure that it has not become acidic. Please refer to guidelines provided by the glycol manufacturer regarding glycol maintenance.

NOTE: Glycol may only be used in the closed loop circuit.

1. Follow the fluid manufacturer’s instructions for determining glycol concentration for the level of freeze protection needed. It is recommended to pre-mix the fluid before introducing it to the system. Remember to include the expansion tank when calculating the total system volume.
2. Local codes may require back flow preventer or actual disconnect from city water supply.
3. When using freeze protection fluid with automatic fill, install a water meter to monitor water makeup. Freeze protection fluid may leak before the water begins to leak, causing concentration to drop, reducing the freeze protection level.
4. Glycol in hydronic applications should include inhibitors that prevent the glycol from attacking metallic system components. Make certain that the system fluid is checked for the correct glycol concentration and inhibitor level.
5. The glycol solution should be tested at least once a year or as recommended by the glycol manufacturer.
6. Anti-freeze solutions affect system performance, as shown in the table below. The system design must also account for their thermal expansion.
7. The use of glycol can increase the risk of corrosion in the piping system.

Ethylene glycol aqueous solution concentration	Antifreeze freezing point temperature (°F)	Water pump power consumption	Heat transfer capacity (compared with pure water)	Heat pump system high pressure (compared with pure water system)	Change in heating capacity after addition of glycol (compared to pure water system)	Change COP of the whole machine (compared to pure water system)
22%	14°F	115%	74%	130%	75%	75%
29%	5°F	115%	70%	143%	68%	68%
35%	-4°F	118%	67%	150%	62%	65%
47%	-22°F	120%	62%	162%	60%	60%

Table 22 - System performance with anti-freeze solutions

NOTICE

The propylene glycol is a recommended solution for regions where ethylene glycol is restricted.

Key Technical Considerations:

- Concentration Ratio: For optimal freeze, burst protection and heat transfer efficiency, we recommend verifying with local codes and best engineering practices for your area to determine the best mix % of glycol and water with a maximum of 50%.
- Inhibitor Requirements: Use only inhibited propylene glycol (e.g., with corrosion/scale inhibitors) to protect the hydraulic components. Non-inhibited glycol may reduce system longevity.
- System Adjustments: Please refer to the glycol manufacturers viscosity levels to ensure proper circulation pumps have been selected to accommodate any flow restriction.
- In most cases, the use of glycol will affect heat transfer and must be taken into account when sizing the proper heat pumps capacities. Please refer to the tables below for correction factors and the glycol manufacturers recommendations.

6.1 Error code

Code	Error	Analysis and Troubleshooting - Principle	Manual Reset or Auto Reset	HP Operation During Error
Analysis and Troubleshooting - Description				
F01	Outdoor ambient temp. sensor failure	When the outdoor main PCB detects a short circuit or disconnection of the ambient temperature sensor port, the unit reports a fault and shuts down;		
Accessories and tools: temp. sensor, outdoor main PCB, multimeter 1.1. Bad/loose connection: find the connector of the ambient temp. sensor according to the wiring diagram, then check whether the sensor terminal and outdoor main PCB terminal have poor connect, pull the sensor out again and install it back in after checking, if the fault code is cleared, then pull the sensor lead towards the electrical box to ensure that there is no pulling influence between the sensor terminal and the PCB terminal. If the fault is not cleared, check according to steps as below. 1.2. Sensor fault: pull out the sensor from the outdoor main PCB, then measure the resistance value of the sensor by multimeter. If there is no resistance value or the resistance value is infinite, it means that the sensor is damaged. Therefore, the sensor should be replaced. <i>(Please refer to the 5K resistance list below the error code list)</i> 1.3. Outdoor main PCB fault: pull the sensor out of the outdoor main PCB and re-wire a spare sensor, then observe whether the fault on the control panel is cleared. If the fault is not cleared, it means that the outdoor main PCB is damaged and the outdoor main PCB should be replaced. 2. Change the wiring of the sensor in PCB's ports: trade the wiring of the ambient temp. sensor and outdoor coil temp. sensor (or other sensors except the discharge temp. sensor), and check whether the ambient temp. displayed on the controller is normal. If yes, then it can be confirmed that the sensor contact is poor. If the fault is still F01, then the outdoor main PCB may be faulty (need to replace it). If the fault becomes other sensor failure, it can be confirmed that the ambient temp. sensor is faulty (need to replace this faulty sensor). Note: after troubleshooting by this method, the sensor must be restored to its original position.			Auto Reset	No operation
F02	Outdoor coil temp. sensor failure	When the outdoor main PCB detects a short circuit or disconnection of the outdoor coil temp. sensor port, the unit reports a fault and shuts down;		
Accessories and tools: temp. sensor, outdoor main PCB, multimeter 1.1. Bad/loose connection: find the connector of the outdoor coil temp. sensor according to the wiring diagram, then check whether the sensor terminal and the outdoor main PCB terminal have poor connect, pull the sensor out again and install it back in after checking, if the fault code is cleared, then pull the sensor lead towards the electrical box to ensure that there is no pulling influence between the sensor terminal and the PCB terminal; if the fault is not cleared, check according to steps as below. 1.2. Sensor fault: pull out the sensor from the outdoor main PCB, then measure the resistance value of the sensor by multimeter. If there is no resistance value or the resistance value is infinite, it means that the sensor is damaged. Therefore, the sensor should be replaced; 1.3. Outdoor main PCB fault: pull the sensor out of the outdoor main PCB and re-wire a spare sensor, then observe whether the fault on the controller is cleared. If the fault is not cleared, it means that the outdoor main PCB is damaged and the outdoor main PCB should be replaced <i>(Please refer to the 5K resistance list below the error code list)</i> . 2. Change the wiring of the sensor in PCB's ports: trade the wiring of the ambient temp. sensor and outdoor coil temp. sensor (or other sensors except the discharge temp. sensor), and check whether the outdoor coil temp. displayed on the controller is normal. If yes, then it can be confirmed that the sensor contact is poor. If the fault is still F02, then the outdoor main PCB may be faulty (need to replace it). If the fault becomes other sensor failure, it can be confirmed that the outdoor coil temp. sensor is faulty (need to replace this faulty sensor), Note: after troubleshooting by this method, the sensor plug must be restored to its original position.			Auto Reset	No operation
F03	Compressor discharge temp. sensor failure	When the outdoor main PCB detects a short circuit of the discharge temp. sensor or after compressor switching on 10min, detect a broken of discharge temp. sensor, the unit reports a fault and shuts down;		
Accessories and tools: temp. sensor, outdoor main PCB, Multimeter 1. Sensor fault: pull out the sensor from the outdoor main PCB, then measure the resistance value of the sensor by multimeter. If there is no resistance value or the resistance value is infinite, it means that the sensor is damaged. Therefore, the sensor should be replaced <i>(Please refer to the 50K resistance list below the error code list)</i> . 2. Poor connect: find the connector of the discharge temp. sensor according to the wiring diagram, then check whether the sensor terminal and the outdoor main PCB terminal have poor connect, pull the sensor out again and install it back in after checking, if the fault code is cleared, then pull the sensor lead towards the electrical box to ensure that there is no pulling influence between the sensor terminal and the main PCB terminal; Then turn on the unit and count the 10mins running time. During the operation of the unit, check whether the display of the discharge temp. on the system diagram of the controller is normal or not. If the discharge temp. can rise normally and is higher than the water outlet temp., then the problem of the poor contact is solved. if the discharge temp. has been below 32°F for 10 minutes, then it is necessary to check according to step 3. 3. Outdoor main PCB fault: pull out the sensor from the outdoor main PCB and re-wire a spare sensor (50K), if the ambient temp. is less than 32°F at this time, please hold the spare sensor in hand until the temp. is raised to more than 32°F. Then observe whether the discharge temp. displayed on the system diagram of the controller is higher than 32°F. if so, it means that there is no problem with the outdoor main PCB. if not, it means that the outdoor main PCB is damaged and should be replaced. 4. Loosening or falling off of the sensor probe: replacing the discharge temp. sensor, disassemble the unit and check whether the discharge temp. sensor is loose from the sensor install pipe and falls off, if so, retighten it.			Auto Reset	No operation

Part 6 - Troubleshooting

Code	Error	Analysis and Troubleshooting - Principle	Manual Reset or Auto Reset	HP Operation During Error
Analysis and Troubleshooting - Description				
F04	Compressor suction temp. sensor failure	When the outdoor main PCB detects a short circuit or disconnection of the suction temp. sensor port, the unit reports a fault and shuts down.		
<p>Accessories and tools: temp. sensor, outdoor main PCB, Multimeter</p> <ol style="list-style-type: none"> 1.1. Poor connect: find the connector of the suction temp. sensor according to the wiring diagram, then check whether the sensor terminal and PCB terminal have poor connect, pull the sensor out again and install it back in after checking, if the fault code is cleared, then pull the sensor lead towards the electrical box to ensure that there is no pulling influence between the sensor terminal and the PCB terminal; if the fault is not cleared, check according to steps as below. 1.2. Sensor fault: pull out the sensor from the outdoor main PCB, then measure the resistance value of the sensor by multimeter. If there is no resistance value or the resistance value is infinite, it means that the sensor is damaged. Therefore, the sensor should be replaced (<i>Please refer to the 5K resistance list below the error code list</i>). 1.3. Outdoor main PCB fault: pull the sensor out of the outdoor main PCB and re-wire a spare sensor, then observe whether the fault on the controller is cleared. If the fault is not cleared, it means that outdoor main PCB is damaged and should be replaced. <p>2. Change the wiring of the sensor in PCB's ports: trade the wiring of the ambient temp. sensor and suction temp. sensor (or other sensors except the discharge temp. sensor), and check whether the suction temp. displayed on the controller is normal. If so, then it can be confirmed that the sensor contact is poor. If the fault code is still display F04, then outdoor main PCB may be faulty (need to replace it). If the fault becomes other sensor failure, it can be confirmed that the suction temp. sensor is faulty (need to replace this faulty sensor).</p> <p>Note: after troubleshooting by this method, the sensor plug must be restored to its original position.</p>			Auto Reset	No operation
F05	Low pressure sensor failure	When the outdoor main PCB detects that the low pressure sensor is disconnected, the unit reports a fault and shuts down;		
<p>Accessories and tools: temp. sensor, outdoor main PCB, Multimeter</p> <ol style="list-style-type: none"> 1. If the unit reports the fault codes both of F05 and F06 at the same time, measure the voltage of compressor sensor port by multimeter (DC gear, in the case of normal connection between the sensor and the outdoor main PCB), and measure the voltage between GND and +5V. If the measured voltage is 0 or less than 4V, it means that the outdoor main PCB is damaged and should be replaced. 2. When the unit is in standby, if the Δpressure value between low pressure and high pressure shows more than 10%, then can be checked according to steps 3.1, 3.2 or 4; If there is no obvious difference between the display of low pressure value and high pressure value, startup the unit and observe its running. If the low pressure drops to 0 bar quickly (within 90 seconds) after the compressor is started, then refer to the troubleshooting of EEV. If only report the fault code of F05, there are two ways to troubleshoot the fault as below. 3.1 Poor connect: find the connector of the low pressure sensor according to the wiring diagram, then check whether the sensor terminal and the outdoor main PCB terminal have poor connect, pull the sensor out again and install it back in after checking, if the fault code is cleared, then pull the sensor lead towards the electrical box to ensure that there is no pulling influence between the sensor terminal and the PCB terminal. If the fault is not cleared, check according to step 3.2. 3.2. Sensor or connecting line fault: in the case of the unit is powered on but not switched on, measure the voltage of compressor sensor port by multimeter (DC gear, in the case that sensor and PCB is connected normally), and measure the voltage between GND and PS, if there is no PS voltage, either the sensor or the sensor connecting line is damaged. Therefore, please replace the sensor connecting line firstly. If the fault code is not cleared after the replacement, the sensor also need to be replaced. 4. Outdoor main PCB problem: pull the pressure sensor out of the outdoor main PCB and re-wire a spare pressure sensor (no need to install in the pipe), observe whether the fault code on the controller are cleared or not. If the fault is not cleared, it means that the outdoor main PCB is damaged and need to be replaced. 			Auto Reset	No operation
F06	High pressure sensor failure	When the outdoor main PCB detects that the high pressure sensor is disconnected, the unit reports a fault and shuts down;		
<p>Accessories and tools: temp. sensor, outdoor main PCB, Multimeter</p> <ol style="list-style-type: none"> 1. If the unit reports the fault codes both of F05 and F06 at the same time, measure the voltage of compressor sensor port by multimeter (DC gear, in the case of normal connection between the sensor and the outdoor main PCB), and measure the voltage between GND and +5V. If the measured voltage is 0 or less than 4V, it means that the outdoor main PCB is damaged and should be replaced. 2. When the unit is in standby, if the Δpressure value between low pressure and high pressure shows more than 10%, then can be checked according to steps 3.1, 3.2 or 4; If there is no obvious difference between the display of low pressure value and high pressure value, startup the unit and observe its running. If the low pressure drops to 0 bar quickly (within 90 seconds) after the compressor is started, then refer to the troubleshooting of EEV. If only report the fault code of F06, there are two ways to troubleshoot the fault as below. 3.1 Poor connect: find the connector of the high pressure sensor according to the wiring diagram, then check whether the sensor terminal and the outdoor main PCB terminal have poor connect, pull the sensor out again and install it back in after checking, if the fault code is cleared, then pull the sensor lead towards the electrical box to ensure that there is no pulling influence between the sensor terminal and the PCB terminal. If the fault is not cleared, check according to step 3.2. 3.2. Sensor or connecting line fault: in the case of the unit is powered on but not switched on, measure the voltage of compressor sensor port by multimeter (DC gear, in the case that sensor and PCB is connected normally), and measure the voltage between GND and PS, if there is no PS voltage, either the sensor or the sensor connecting line is damaged. Therefore, please replace the sensor connecting line firstly. If the fault code is not cleared after the replacement, the sensor also need to be replaced. 4. Outdoor main PCB problem: pull the pressure sensor out of the outdoor main PCB and re-wire a spare pressure sensor (no need to install in the pipe), observe whether the fault code on the controller are cleared or not. If the fault is not cleared, it means that the outdoor main PCB is damaged and need to be replaced. 			Auto Reset	No operation

Code		Error		Analysis and Troubleshooting - Principle	
Analysis and Troubleshooting - Description				Manual Reset or Auto Reset	HP Operation During Error
F07	High pressure switch failure	When the unit has 3 consecutive high pressure switch protections (P05) within 30 minutes, F07 will be reported and the unit will shut down, and the unit cannot be startup unless re-power.			
Accessories and tools: temp. sensor, outdoor main PCB, Multimeter. 1. When the unit is in standby, if the Δ pressure value between the low pressure and the high pressure shows more than 10% in control panel, then measure the gas pressure by pressure gauge (connect the compressor discharge side via high-pressure needle valve, if there are no high-pressure needle valve, connect to the low-pressure needle valve), if there have obvious deviation between the high-pressure sensor detection value and gauge's measurement value, the high pressure sensor need to be replaced. 2. If there is no obvious difference between the value of the low pressure and high pressure, replace the high pressure switch. Note: Replace the high-pressure switch, set the maximum water temperature that the system is allowed to run the unit. Then observe the change of high pressure value during the operation, and observe whether there is still report F08 because of the high pressure protection not timely, and check whether the refrigerant system and the hydro system is abnormal.				Manual Reset	No operation
F08	Low pressure switch failure	When the unit has 3 consecutive Low pressure switch protections (P13) within 30 minutes, F08 will be reported and the unit will shut down, and the unit cannot be startup unless re-power.			
For troubleshooting methods, refer to P13.					
F09	DC fan motor A failure	The unit with only one fan (Capacity $\leq 12kW$): If the fan motor startup failed when the outdoor main PCB send fan's running command, the unit will report DC fan A failure, then the unit will shutdown.			
F10	DC fan motor B failure	The unit with 2 fan (Capacity $\geq 15kW$): If the fan motor startup failed when the outdoor main PCB send fan's running command, the unit will report DC fan A failure, then the unit will keep running but compressor frequency will be limited.			
Replacement parts and tools: spare fan motor, outdoor main PCB, Multimer Only one fan unit: 1. Confirm that the fan blade are not jammed by something. 2. Power off the unit, then confirm that the fan blade can turn or not, if not, replace the fan motor. 3. Power off the unit, check whether the terminal are loose or poor contact on the PCB or transfer joint, pull out the terminal out and install it back in again. 4. Power on and startup the unit, measure the voltage supplied to the DC fan port via multimeter (DC voltage) 4.1. Check the voltage between Vcc and GND is 15VDC or not, if the measure value is bigger than 18VDC, replace the outdoor PCD and fan motor. 4.2. If the voltage of VCC is normal, wire the spare fan motor with outdoor main PCB, and standup the heat pump to check whether the motor can run normally, if normal, power off the unit and install the motor; if abnormal, replace the outdoor main PCB. Two-fan unit: 1. Check base on the same 4 steps as above. 2. If one of the two fan is running normally, power off the unit, and wire the two fan ports inversely (fan motor A connect fan B port, fan motor B connect fan A port), then re-power and startup the unit, observe the fan's operation. If the failed fan is still failure, replace its motor. If the otherwise normal fan is not running, replace the fan motor driver PCB. 3. If both two fans do not run, check the voltage of VCC is normal by step 4.1, remove the two failed motor and wire the spare motor to fan A port of the fan motor driver PCB, power on and startup the unit, observe whether the motor can run normally; then power off again, and wire the spare motor to fan B port, re-power and startup the unit, observe whether the motor can run normally. If the spare motor does not operate on either port, replace the fan motor driver PCB. If the spare motor operate normally on both ports, re-install the fan motor A, and startup the unit, if the fan A does not operate, fan motor A is damaged; Then remove the fan motor A, and re-install the fan motor B, startup the unit, if the fan B does not operate, fan motor B is damaged, the damaged fan motor should be replaced.				Auto Reset	(P09) Single fan unit: No operation Two-fan units: compressor frequency-limited operation
F11	Low pressure failure	Low pressure protection happens three times within 30min for P18. Unit stops and failure can only be cleared by repowering.			
Accessories and tools: refrigerant, leakage detector, pressure gauge, vacuum pump, USB disk 1. When unit is off, read refrigerant pressure value from display (unit should stay standby $>30min$) for first judgement if serious leakage happens. If saturation temperature corresponding to the displayed refrigerant pressure is at same level of ambient temperature, it is fine. If it is lower than ambient temperature for more than $9^{\circ}F$, leakage could happen. 2. For split units, check whether the refrigerant piping exceeds 15 meters and the refrigerant has not been replenished; if so, replenish the refrigerant according to the length of the piping; 3. Start the unit and observe the change of low pressure. If the low pressure is too low (i.e., the evaporating temperature is lower than the ambient temperature by more than $50^{\circ}F$), and the running time is more than 5 minutes, it can be preliminarily judged as a potential leakage. Fill about 100 to 200g to see whether the low pressure of the system is increased. If yes, proceed leakage test on the system. After finding out leakage point and fixing it, vacuum the heat pump system. Then recharge the unit with correct amount of refrigerant based on info from nameplate.				Manual Reset	No operation

Part 6 - Troubleshooting

Code	Error	Analysis and Troubleshooting - Principle	Manual Reset or Auto Reset	HP Operation During Error
Analysis and Troubleshooting - Description			Manual Reset or Auto Reset	HP Operation During Error
F12	High pressure failure	High pressure protection (P06) happens three times within 30min. Unit stops and failure can only be cleared by repowering.		
<p>Accessories and tools: descaling equipment, USB disk</p> <p>Note: On the display, check data records of the last three reports of high pressure protection in the failure history. Confirm the temperature difference between the inlet and outlet water temperature and the outlet water temperature value at the time of failure happened. Then restart the unit by powering to have it run again, and make the following judgments during the operation process:</p> <ol style="list-style-type: none"> High pressure too high problem in heating mode: <ol style="list-style-type: none"> Insufficient water flow: Check whether the temperature difference between the inlet and outlet water temperature of the unit is between 5 and 9°F. If it is far more than 9°F (e.g., more than 14°F) and the system operated normally before, check the filters in the water system to see if there is any dirty blockage and clean them. If it is a newly-installed system, check whether the pump is set to run at low speed, and try to run the pump at a medium or high speed to ensure that the water flow is in a normal range. Ensure that system is done with air purge properly. Check whether the water pressure of the system is far below 2.0 bar and whether there is any abnormality in the water system that leads to excessive water resistance of the system; Sensor reading deviation: Check the temperature difference between the unit's water outlet temperature and the TC temperature or TW temperature. Under normal circumstances, the water outlet temperature will be 5 to 9°F higher than the TC or TW. If it exceeds 9°F, please check whether the TC and TW sensors are not well in position or the installation position is not suitable. TC or TW should be installed in the upper part of the tank; Heat exchanger scaling: In the process of unit operation, observe whether the temperature of the indoor coil is more than 41°F higher than the water outlet temperature. If so, there can be scaling in the plate exchange, cleaning will be needed to remove the scale; Cooling mode with high pressure problem: Check whether the evaporator of the outdoor unit is dirty and blocked or there is poor heat dissipation around the external unit. If so, consider adding a wind guide ring to the unit, so that the hot air can be discharged in a timely manner; If the above solution fails to solve the problem, the EEV of the refrigerant system may be abnormal. Please refer to "EEV troubleshooting section." 			Manual Reset	No operation
F13	Room temp. sensor failure	When the operation panel is set to room temperature control mode or the room temperature curve fine-tuning function is active, and the room temperature sensor is detected to be disconnected or shorted, the unit will report a fault and be shut down;		
<p>Accessories and tools: sensors. main PCB. multimeter</p> <ol style="list-style-type: none"> Poor contact: Based on unit wiring diagram, find the connection of the temperature sensor. Check contact between sensor terminals and PCB terminals if it is poor. If yes, pull the sensor out and plug it back in. If the fault is cleared, pull the sensor leads toward the electrical box to ensure that there is no tension between the sensor terminals and PCB terminals. If the fault is not cleared, then check according to point 2. Main PCB problem: Pull the sensor out from main PCB and reinsert a new sensor to see whether the failure on display is cleared or not. If the fault is not cleared, it means that the main PCB is damaged. Please replace the main PCB. If it is cleared, first test the intermediate connecting wire whether there is a short circuit or a broken circuit. If yes, replace the intermediate connecting wire. If no, replace the room temperature sensor. 			Auto Reset	No operation
F14	Hot water temp. sensor failure	When the hot water mode is active, if a disconnected or shorted hot water temperature sensor is detected, the unit will report a fault and be shut down;		
<p>Accessories and tools: sensors. main PCB. multimeter</p> <ol style="list-style-type: none"> Poor contact: Based on unit wiring diagram, find the connection of the temperature sensor. Check contact between sensor terminals and PCB terminals if it is poor. If yes, pull the sensor out and plug it back in. If the fault is cleared, pull the sensor leads toward the electrical box to ensure that there is no tension between the sensor terminals and PCB terminals. If the fault is not cleared, then check according to point 2; Main PCB problem: Pull the sensor out from main PCB and reinsert a new sensor to see whether the failure on display is cleared or not. If the fault is not cleared, it means that the main PCB is damaged. Please replace the main PCB. If it is cleared, first test the intermediate connecting wire whether there is a short circuit or a broken circuit. If yes, replace the intermediate connecting wire. If no, replace the room temperature sensor. 			Auto Reset	No operation
F15	TC (heating/cooling) water temp. sensor failure	When heating/cooling mode is active, if a disconnected or shorted TC sensor is detected, the unit will report a fault and be shut down;		
<p>Accessories and tools: sensors. main PCB. multimeter</p> <ol style="list-style-type: none"> Poor contact: Based on unit wiring diagram, find the connection of the temperature sensor. Check contact between sensor terminals and PCB terminals if it is poor. If yes, pull the sensor out and plug it back in. If the fault is cleared, pull the sensor leads toward the electrical box to ensure that there is no tension between the sensor terminals and PCB terminals. If the fault is not cleared, then check according to point 2. Main PCB problem: Pull the sensor out from main PCB and reinsert a new sensor to see whether the failure on display is cleared or not. If the fault is not cleared, it means that the main PCB is damaged. Please replace the main PCB. If it is cleared, first test the intermediate connecting wire whether there is a short circuit or a broken circuit. If yes, replace the connecting wire. If no, replace the TC temperature sensor. 			Auto Reset	No operation

Code		Error		Analysis and Troubleshooting - Principle	
Analysis and Troubleshooting - Description				Manual Reset or Auto Reset	HP Operation During Error
F16	Water outlet temp. sensor failure	When display detects that the water outlet temperature sensor is disconnected or shorted, it will report a failure but unit will not be shut down. Unit keeps working with water inlet temperature + stop ΔT as target temperature. If both the water inlet and outlet water temperature fails, it will be shut down;		Auto Reset	<p>Only F16: Normal operation</p> <p>When both F16 and F17 are reported: No operation</p>
<p>Accessories and tools: sensors. main PCB. multimeter</p> <p>Note: For split unit, indoor control PCB and water outlet temperature sensor are in indoor unit For monoblock unit, indoor control PCB is in indoor unit and water outlet temperature sensor is in outdoor unit.</p> <ol style="list-style-type: none"> Poor contact: Based on unit wiring diagram, find the connection of the temperature sensor. Check contact between sensor terminals and PCB terminals if it is poor. If yes, pull the sensor out and plug it back in. If the fault is cleared, pull the sensor leads toward the electrical box to ensure that there is no tension between the sensor terminals and PCB terminals. If the fault is not cleared, then check according to point 2. Main PCB problem: Pull the sensor out from main PCB and reinsert a new sensor to see whether the failure on display is cleared or not. If the fault is not cleared, it means that the main PCB is damaged. Please replace the main PCB. If it is cleared, then check according to point 3. Sensor problem: <ol style="list-style-type: none"> For split unit, pull sensor out from control PCB and use multimeter to detect resistance of sensor. If the resistance value is infinite or no resistance value, then replace the sensor. For monoblock unit, check according to 3.1. While for unit with an intermediate connection cable (and the indoor panel is not inside the outside unit), the status of the intermediate connection cable should also be checked. 					
F17	Water inlet temp. sensor failure	When display detects that the water inlet temperature sensor is disconnected or shorted, it will report a failure but unit will not be shut down. Unit keeps working with water inlet temperature + stop ΔT as target temperature. If both the water inlet and outlet water temperature fails, it will be shut down.		Auto Reset	<p>Only F17: Normal operation</p> <p>When both F16 and F17 are reported: No operation</p>
<p>Accessories and tools: sensors. main PCB. multimeter</p> <p>Note: For split unit, indoor main PCB and water outlet temperature sensor are in indoor unit For monoblock unit, indoor main PCB is in indoor unit and water outlet temperature sensor is in outdoor unit.</p> <ol style="list-style-type: none"> Poor contact: Based on unit wiring diagram, find the connection of the temperature sensor. Check contact between sensor terminals and PCB terminals if it is poor. If yes, pull the sensor out and plug it back in. If the fault is cleared, pull the sensor leads toward the electrical box to ensure that there is no tension between the sensor terminals and PCB terminals. If the fault is not cleared, then check according to point 2. Main PCB problem: Pull the sensor out from main PCB and reinsert a new sensor to see whether the failure on display is cleared or not. If the fault is not cleared, it means that the main PCB is damaged. Please replace the main PCB. If it is cleared, then check according to point 3. Sensor problem: <ol style="list-style-type: none"> For split unit, pull sensor out from main PCB and use multimeter to detect resistance of sensor. If the resistance value is infinite or no resistance value, then replace the sensor. For monoblock unit, check according to 3.1. While for unit with an intermediate connection cable (and the indoor panel is not inside the outside unit), the status of the intermediate connection cable should also be checked. 					
F18	Indoor coil temp. sensor failure	When cooling mode is active, if the indoor coil temperature sensor is detected to be disconnected or shorted, the unit will report a fault and be shut down. When heating mode or hot water mode is active, failure remains but unit will continue to run for heating or hot water.		Auto Reset	<p>Cooling: No operation</p> <p>For heating and hot water: normal operation</p>
<p>Accessories and tools: sensors. main PCB. multimeter</p> <p>For monoblock unit, indoor main PCB is in indoor unit and water outlet temperature sensor is in outdoor unit.</p> <ol style="list-style-type: none"> Poor contact: Based on unit wiring diagram, find the connection of the temperature sensor. Check contact between sensor terminals and PCB terminals if it is loose. If yes, pull the sensor out and plug it back in. If the fault is cleared, pull the sensor leads toward the electrical box to ensure that there is no tension between the sensor terminals and PCB terminals. If the fault is not cleared, then check according to point 2. Main PCB problem: Pull the sensor out from main PCB and reinsert a new sensor to see whether the failure on display is cleared or not. If the fault is not cleared, it means that the main PCB is damaged. Please replace the main PCB. If it is cleared, then check according to point 3. Sensor problem: <ol style="list-style-type: none"> For split unit, pull sensor out from main PCB and use multimeter to detect resistance of sensor. If the resistance value is infinite or no resistance value, then replace the sensor. For monoblock unit, check according to 3.1. While for unit with an intermediate connection cable (and the indoor panel is not inside the outside unit), the status of the intermediate connection cable should also be checked. 					
F19	Water flow sensor failure	When the water flow sensor is installed on the outdoor main PCB, if there is no feedback signal is detected from the water flow sensor, it means the water flow sensor is failure, the unit will report a fault and be shut down.		Auto Reset	No operation
<p>Accessories and special tools: water flow sensor. main PCB. multimeter</p> <ol style="list-style-type: none"> Check whether the water flow sensor connecting cable of the outdoor unit is loose or disconnected, find out the water flow sensor terminal according to the wiring diagram, pull it out and then plug it back in again, if the failure can't be cleared, carry to step 2. When the P0 water pump is running, use a multimeter (DC voltage gear), test the voltage of the water flow port, whether the voltage between GND port and 12V port is 12V, and whether the voltage between GND port and PS3 port is >0. If the voltage is >0, replace the outdoor main PCB, if the voltage is =0, replace the water flow sensor; When the pump is running, check if the the value of water flow is close to or less than the minimum allowable flow rate of the unit. If so, refer to failure code S02: water flow switch protection, to find out the reason of insufficient of water flow in the system and then solve the problem. If parameter for pump setting is set to "PWM" and no "PWM" signal is received from the pump to the PCB then this fault can occur. If the pump is PWM type, then check wiring. If pump is AC type, then change parameter to "AC". 					

Part 6 - Troubleshooting

Code	Error	Analysis and Troubleshooting - Principle		
Analysis and Troubleshooting - Description			Manual Reset or Auto Reset	HP Operation During Error
F20	Refrigerant leakage protection	When equipped with refrigerant leakage detection function, if refrigerant leakage is detected, after 3 times reported the P16 , F20 will then be reported, at this time, the unit will be locked up and cannot be recovered until repower.		
Accessories and tools: refrigerant leakage detector. main PCB. multimeter. USB disk. 1. When unit is in Off state, check the refrigerant pressure value in standby state through operation panel(standby time should more than 30 minutes),to confirm whether there is a serious leakage of refrigerant firs.The judgment: whether the saturation temperature that corresponding to the current displayed refrigerant pressure value is the same as the ambient temperature, and if the refrigerant pressure value is lower than the ambient temperature by more than 41°F, then can judge that there is a leakage of refrigerant basically. 2. Check whether the refrigerant system have leakage problem, use refrigerant leakage detector, check inside the compressor cabinet, check if the refrigerant detection box have leakage alarming, if so, can double check where the leakage point is, if not, carry out the check in step 3. 3. Replace the refrigerant detector(sensor), and then repower the unit, to analyze the way according to step 4. 4. Observe the change of low pressure, if the low pressure is too low (i.e. the evaporating temperature is lower than the ambient temperature by more than 50°F), and the operation time of the unit is more than 5 minutes, it can judge there is a leakage point. Can temporarily supplemented with 100-200g refrigerant to see if the low pressure will have rebound, if so, re-vacuum the unit and re-inject the refrigerant according to the refrigerant amount on the nameplate.			Manual Reset	No operation
F21	3-way valve mixing temp. sensor 1 failure	When the mixing valve function is valid, if the mixing water temperature sensor 1 is detected to be disconnected or short circuit, F21 is reported, but the unit does not stop.		
Accessories and tools: sensor. main PCB. multimeter 1. Poor contact: find the interface of the temperature sensor according to the wiring diagram , check if the sensor terminals and PCB terminals is poor contact, pull it out and then plug it back in again, if the failure is cleared, then pull longer the sensor toward the electrical box to ensure here is no tension between the sensor terminals and PCB terminals; if the failure is not cleared, then check according to step 2. 2. Main PCB problem: pull the sensor out of the circuit PCB and plug in a temporary sensor, observe whether the failure on the operation panel is cleared or not, if the failure is not cleared, it means that the main PCB is damaged, replace the main PCB ; if the failure is cleared, first check if the intermediate connecting wire is in short circuit or in broken circuit, if there is, replace the intermediate connecting wire, if there is not, replace the room temperature sensor.			Auto Reset	Unit operates normally, but secondary pump stops
F22	3-way valve mixing temp. sensor 2 failure	When the mixing valve function is valid, if the mixing temperature sensor 2 is detected to be disconnected or short circuit, F21 is reported, but the unit does not stop.		
Accessories and tools: sensor. main PCB. Multimeter. 1. Poor contact: find the interface of the temperature sensor according to the wiring diagram , check if the sensor terminals and PCB terminals is poor contact, pull it out and then plug it back in again, if the failure is cleared, then pull longer the sensor toward the electrical box to ensure here is no tension between the sensor terminals and PCB terminals; if the failure is not cleared, then check according to step 2. 2. Main PCB problem: pull the sensor out of the circuitl PCB and plug in a temporary sensor, observe whether the failure on the operation panel is cleared or not, if the failure is not cleared, it means that the main PCB is damaged, replace the main PCB ; if the failure is cleared, first check if the intermediate connecting wire is in short circuit or in broken circuit, if there is, replace the intermediate connecting wire, if there is not, replace the room temperature sensor.			Auto Reset	Unit operates normally, but secondary pump stops
F23	Reserved			
F24	Reserved			
F25	Reserved			
F26	Reserved			
F27	Indoor EEPROM failure	When the EEPROM data of the indoor main PCB cannot be read, F27 is reported and the unit is shut down.		
Accessories and tools: indoor main PCB Replace the indoor PCB;			Auto Reset	No operation
F28	Water pump PWM signal failure	When the P0 water pump is set to be controlled by PWM pump, if without feedback signal is detected after the water pump runs for 120 seconds, F28 is reported and the unit is shut down.		
Accessories and tools: water pump.main PCB. multimeter Check whether the water pump PWM signal cable is loose or poor contact, when unit is in Off state, pull it out and then plug it back in again, and then repowered and run the unit, observe whether the failure is cleared after the water pump runs for 2 minutes. At the same time, within 2 minutes, use DC voltage gear of the multimeter to measure if the the feedback voltage of the water pump PWM terminal on the indoor main PCB is >0V, if so, replace the indoor main PCB, if not, replace the PWM signal cable, if still cannot clear the failure, replace t he water pump;			Auto Reset	No operation

Code		Error		Analysis and Troubleshooting - Principle	
Analysis and Troubleshooting - Description				Manual Reset or Auto Reset	HP Operation During Error
F29	Mixing valve 1 failure	When the mixing valve function is valid, in the heating mode, the mixing water temperature 1-set temperature is in system 1 > 7°F; or in the cooling mode, the mixing water temperature 1-set temperature in system 1 < 7°F, and the mixing valve is adjusted to 0V and kept for 10 minutes, then 3-way valve 1 failure is reported, the secondary water pump is shut down, but the heat pump will keep operating.			
<p>Accessories and tools: mixing valve. main PCB. Multimeter.</p> <ol style="list-style-type: none"> 1. Check whether the actual TC temperature for heating is lower than the mixing water temperature in the water system diagram of the operation panel, if so, check the installation position of the mixing water temperature sensor; or check if the floor of the room is exposed to direct sunlight so resulting in a high mixing water temperature, if so, can ignore this failure, because when there is no direct sunlight exposed, after the mixing water temperature drops the failure will be cleared automatically. 2. Check whether the actual TC temperature for heating is higher than the mixing water temperature in the water system diagram of the operation panel, if so, keeping checking as following: <ol style="list-style-type: none"> 2.1. According to the wiring diagram, use a multimeter (DC voltage gear) to measure whether the 24V power supply of the mixing valve is normal or not, if not normal, check whether the connecting cables between the mixing valve and the main PCB is loose or disconnected. 2.2. Power off and restart the unit, according to the wiring diagram, use a multimeter (DC voltage gear) to measure if the control signal of water mixing valve decrease from 5V down to 0V in the way about every 20 seconds decrease 0.5V, if so, higher the setting temperature of the mixing temperature (9°F higher than the current mixing temperature). Then test if the mixing valve control signal increase in about every 20 seconds increase 0.5V, at the same time, observe if the mixing water temperature have tendency to increase, if not, either the mixing valve coil is abnormal, or the mixing valve is stuck. 3. Replace the valve coil. When unit is in Off state, replace the cables and coil. If there is an extension cable in the middle, can first check if the extension cable is poor contact: disconnect both ends of the extension cable, in one end of the cable connect 0V and 10V together, and connect 0V with 24V together, then use the on and off gear of multimeter to measure the other end of the cable between 0V and 10V, 0V and 24V to see whether it is conducting, if it is conducting, replace the valve coil, if it not conduct, replace the intermediate connecting cable first then repeat the operation in step 2.2. 				Auto Reset	Unit operates normally, but secondary pump stops
F30	Mixing valve 2 failure	When the mixing valve function is valid, in the heating mode, the mixing water temperature 2-set temperature is in system 2 > 7°F; or in the cooling mode, the mixing water temperature 2-set temperature in system 2 < 7°F, and the mixing valve is adjusted to 0V and kept for 10 minutes, then 3-way valve 2 failure is reported, the secondary water pump is shut down, but the heat pump will keep operating.			
<p>Accessories and tools: mixing valve. main PCB. multimeter</p> <ol style="list-style-type: none"> 1. Check whether the actual TC temperature for heating is lower than the mixing water temperature in the water system diagram of the operation panel, if so, check the installation position of the mixing water temperature sensor; or check if the floor of the room is exposed to direct sunlight so resulting in a high mixing water temperature, if so, can ignore this failure, because when there is no direct sunlight exposed, after the mixing water temperature drops the failure will be cleared automatically. 2. Check whether the actual TC temperature for heating is higher than the mixing water temperature in the water system diagram of the operation panel, if so, keeping checking as following: <ol style="list-style-type: none"> 2.1. According to the wiring diagram, use a multimeter (DC voltage gear) to measure whether the 24V power supply of the mixing valve is normal or not, if not normal, check whether the connecting cables between the mixing valve and the main PCB is loose or disconnected. 2.2. Power off and restart the unit, according to the wiring diagram, use a multimeter (DC voltage gear) to measure if the control signal of water mixing valve decrease from 5V down to 0V in the way about every 20 seconds decrease 0.5V, if so, higher the setting temperature of the mixing temperature (8°F higher than the current mixing temperature). Then test if the water mixing valve control signal increase in about every 20 seconds increase 0.5V, at the same time, observe if the mixing water temperature have tendency to increase, if not, either the mixing valve coil is abnormal, or the mixing valve is stuck. 3. Replace the valve coil. When unit is in Off state, replace the cables and coil. If there is an extension cable in the middle, can first check if the extension cable is poor contact: disconnect both ends of the extension cable, in one end of the cable connect 0V and 10V together, and connect 0V with 24V together, then use the on and off gear of multimeter to measure the other end of the cable between 0V and 10V, 0V and 24V to see whether it is conducting, if it is conducting, replace the valve coil, if it not conduct, replace the intermediate connecting cable first then repeat the operation in step 2.2. 				Auto Reset	Unit operates normally, but secondary pump stops
E01	Reserved				
E02	Outdoor main PCB and driver PCB communication failure	When there is no communication between the outdoor main PCB and driver PCB for 30s, the outdoor main PCB will report a failure and unit will be shut down while the driver PCB will also stop working.			
<p>Accessories and tools: Outdoor main PCB. driver PCB. Communication cable. Multimeter</p> <ol style="list-style-type: none"> 1. Cut the power of unit and open the outdoor unit's electrical box. According to the wiring diagram, check whether the communication cable between the outdoor main PCB and driver PCB is loose. Reinsert the communication cable and ensure that it is correctly inserted into the communication ports. 2. Restart the unit and observe if there are indicator lights blinking on the driver PCB. Use a multimeter (set to AC voltage mode) to measure the input voltage of the driver PCB (L+N for single-phase unit, L1+L2+L3 for three-phase unit) to verify its consistency with the power supply. If the power supply is normal for each phase, replace the driver PCB. 3. If the communication failure persists even after replacing the driver PCB, replace the outdoor main PCB. 				Auto Reset	No operation

Part 6 - Troubleshooting

Code	Error	Analysis and Troubleshooting - Principle	Manual Reset or Auto Reset	HP Operation During Error
Analysis and Troubleshooting - Description				
E03	Compressor phase current reading failur	Hardware Damage of driver PCB Compressor Phase Current Sampling Component		
Accessories and tools: driver PCB. Multimeter Replace the compressor driver PCB with a new one.			Auto Reset	No operation
E04	Compressor phase current overload protection	When compressor is operating, if the current of the compressor is higher than the protection value of the driver, unit will report a failure and be shut shown.		
Accessories and tools: driver PCB, EEPROM document, USB flash disk, Multimeter. 1. If the failure occurs on a new unit and the compressor can reach frequency above 60Hz during operation, try to update the EEPROM of outdoor main PCB to avoid problem caused by incorrect settings. 2. If the compressor is not working at all after unit is ON,the problem can be caused by defective driver PCB. Please try to replace the driver PCB. 3. If the compressor starts but shakes unusually with speed below 60Hz while this failure occurs, compressor can be defective with a locked rotor. Restart the unit and try to gently tapping the bottom of the compressor during startup. If the issue persists, replace the compressor (before doing so, if possible, try to replace the compressor driver PCB for check).			Auto Reset	No operation
E05	Compressor driver failure	When the driver PCB fails to activate compressor, unit will report a failure and be shut shown.		
Accessories and tools: driver PCB. Multimeter Check if the wires from the compressor driver PCB to the compressor are securely connected. If the connection is loose, fasten the cables and restart the unit. If compressor is still not functioning, unplug the wires on the compressor and measure the resistance between the different terminals of compressor (between U&V / V&W / U&W) to verify if resistance between different terminals are same or if any circuit is open: 1. If resistance values between different compressor terminals are tested almost equal, try to replace the driver PCB. If the compressor still can not start or shakes unusually after startup with speed below 60Hz while E05 failure happens, compressor can be defective with a locked rotor. Restart the unit and try to gently tapping the bottom of the compressor during startup. If the issue persists, replace the compressor. 2. If resistance values between different compressor terminals are tested unequal or there is any open circuit, compressor is damaged. Replace the compressor.			Auto Reset	No operation
E06	Driver PCB VDC too high/low voltage failure	When the driver PCB detects an excessively high or low rectified DC voltage, drive PCB will stop working and the unit will be shutdown.		
Accessories and tools: drive PCB. DC fan motor. Multimeter 1. Use a multimeter to check if the voltage of the power terminal (L1/L2/L3 for three-phase models) is within normal range: 160V-260V for single-phase and 340V-420V for three-phase. 2. Power off the unit and disconnect the DC fan motor from outdoor main PCB. Repower the unit to check whether the abnormal voltage detection is caused by defective fan motor. If the failure is cleared, replace the DC fan motor. If the issue persists, replace the compressor driver PCB.			Auto Reset	No operation

Code		Error		Analysis and Troubleshooting - Principle	
Analysis and Troubleshooting - Description				Manual Reset or Auto Reset	HP Operation During Error
E07	Input current protection (main control logic protection)	<ol style="list-style-type: none"> If input current is over 4A when compressor is not working or input current is less than 1A when compressor is running at F4 or higher step, unit will report a failure and be shut shown. During the operation of the compressor, if it is detected that the input current is greater than the current protection value of the corresponding model, it will report a fault and shut down. 			
<p>Accessories and tools: refrigerant. Refrigerant leak detector. Pressure gauge. Vacuum pump. Electronic scale. Main PCB. Multimeter.</p> <p>Turn off the secondary water pump, restart the unit, and observe the changes in the current when the unit heat up the buffer water tank, focusing on the high water temperature stage. If the unit does not reduce the frequency before protection, you can try to re-brush the EEPROM.</p> <p>Case 1:</p> <ol style="list-style-type: none"> Restart the unit. After compressor starts, check if the evaporating temperature is much lower than normal range (more than 18°F below ambient) or if the discharge temperature rises obviously higher than normal range (more than 63°F above water temperature). If yes, it may indicate refrigerant leakage. Try to charge the system with certain amount of refrigerant and observe if it works better. For split unit, check whether the refrigerant pipe is over 15 meters and additional refrigerant is charged. If not, charge refrigerant according to the length of piping. Use a multimeter to test the live wire of the power input cable of the outdoor unit and check whether the running current is less than 4A when the unit is standby. If it exceeds 4A, or if running current is less than 1A when the unit starts and runs at above 50Hz, the Main PCB can be defective. Try to replace it. <p>Case 2:</p> <ol style="list-style-type: none"> Turn off the secondary water pump and restart the unit. If the temperature difference between the inlet and outlet water is greater than 46°F, check whether the water pump speed is set to high speed (if it is low speed, please adjust it to medium speed or high speed). Also check the filter in the water system. whether it is blocked; If it is triggered in hot water mode, you can confirm whether the coil of the domestic water tank is too small (the minimum heat exchange area is 3m²). If it is too small, it means that the coil of the water tank is too small, resulting in low heat exchange capacity, causing the heat pump unit to continuously accumulate heat, and eventually the water temperature rises too fast, resulting in excessive current. You can temporarily turn on the hot water ECO mode to see if the hot water ECO mode can alleviate the heat exchange problem of the water tank. If the hot water ECO mode If the problem cannot be solved, you need to replace the coil water tank with a larger coil area (at least 3m³); During operation, observe the difference between the inner coil temperature (TUP) and the outlet water temperature. Under normal circumstances, the inner coil temperature is 34 to 36°F lower than the outlet water temperature. If the inner coil temperature is higher than the outlet water temperature, then Due to the scaling of the plate exchanger, the heat pump heat cannot be exchanged normally, causing an increase in current and causing a malfunction. The plate exchanger can be descaled and cleaned; When triggered in cooling mode, you can check whether the evaporator is dirty or blocked or the installation position causes a heat island effect, resulting in a high current. You can clean the evaporator and adjust the installation position or install an exhaust duct to eliminate the heat island effect. ; The electronic control parameters are set incorrectly, resulting in false alarms from the unit. At this time, you can try to upgrade the EEPROM settings of the main PCB. Check whether the input voltage is normal. If it is more than 10% lower than the rated voltage, excessive current protection may be triggered. Please contact the power supplier to adjust the power supply voltage. 				Auto Reset	No operation
E08	EEPROM failure	When the outdoor main PCB chip cannot read the parameters or there is a parameter verification error, unit will report a failure and be shut shown.			
<p>Accessories and tools: Outdoor main PCB. Multimeter</p> <p>Power off and restart, if the fault still cannot be cleared after restarting, then replace the Outdoor main PCB;</p>				Auto Reset	No operation
E09	Reserved				
E10	Fan drive PCB communication failure.	When the outdoor main PCB detects that there is no communication with the fan driver PCB for more than 2 minutes, a fault is reported. When communication is restored, the fault is cleared.			
<p>Accessories and tools: outdoor main PCB, Fan drive PCB, multimeter.</p> <ol style="list-style-type: none"> Wiring problem: According to the wiring diagram, check whether the A/B port of the communication line has been reversed or has poor contact. Use a multimeter (on/off gear) to test the communication line between the Fan drive PCB and the Outdoor PCB when unit is off. Power supply problem: Check whether the power supply of the Fan drive PCB is normal (230VAC and the PCB has a blinking light). Hardware problem: Replace with a new one. 				Auto Reset	No operation

Part 6 - Troubleshooting

Code	Error	Analysis and Troubleshooting - Principle	Manual Reset or Auto Reset	HP Operation During Error
Analysis and Troubleshooting - Description			Manual Reset or Auto Reset	HP Operation During Error
S01	Cooling anti-freezing protection	In Cooling mode, if the evaporating temperature is detected less than 2°F after the compressor runs for 3 minutes, unit will report a failure and be shut shown.		
Accessories and tools: refrigerant. Refrigerant leak detector. Pressure gauge. Vacuum pump. Electronic scale. Control PCB. Multimeter 1. Check the temperature difference between the inlet and outlet water of the unit. If it exceeds 14°F, check and clean the filter of the water system. Try to adjust the water pump speed to high-speed operation if possible. 2. Check if the outlet water temperature is 45°F or lower. If yes, check and confirm Tc sensor is installed correctly. 3. When unit is off, check the refrigerant pressure value (standby time should be more than 30 minutes) to determine if there is any refrigerant leak. Check if the saturation temperature corresponding to the current pressure value is consistent with the current ambient temperature. If it is lower than the outdoor ambient temperature by more than 9°F, there can be a refrigerant leak. 5. Restart the unit and observe the changes of low-pressure value. If the corresponding refrigerant evaporating temperature falls within the range of 7-11°F, the unit will work with limited compressor speed. If the low-pressure value becomes too low (evaporating temperature below 2°F) and the running time exceeds 3 minutes, while EEV fully open in this period, there is most likely a refrigerant leak. In this case, please charge 100 to 200g of refrigerant and check if the low-pressure of the system rises. If yes, check and fix the leakage of system and then vacuum the unit and recharge the refrigerant according to the product label. 6. If the above troubleshooting are not functioning, the failure can be caused by EEV. Please refer to the "EEV troubleshooting section".			Auto Reset	No operation
S02	Water flow switch protection	When the system pump (P0) starts to run for ≥20 seconds, and the water flow switch is open ≥ 10 seconds, unit will report a failure and be shut shown.		
Accessories and tools: water flow switch, water pump, indoor PCB, multimeter. 1. Check whether system is well done with air purge, whether the water pressure is above 2 bar, whether all valves are open, and whether the filter is blocked or not. 2. Check whether the water pump is running correctly and the water flows in the correct direction after the unit is turned on. 3. Disconnect the water flow switch from the wiring and replace the water flow switch with a jumper on control PCB. Then turn the unit on. If the failure still happened, replace the indoor main PCB. 4.1 If the unit can run normally after replacing the water flow switch with a jumper on PCB, observe whether the inlet and outlet water temperature δT is within a reasonable range (if the compressor running below 50Hz, the inlet and outlet water temperature δT should not be more than 9°F; if it is above 65Hz, the inlet and outlet water temperature δT should not be more than 14°F. Otherwise, the water flow in the system is insufficient. In order to protect the unit, check the condition of air purging, water resistance, water pressure, etc). 4.2 If the inlet and outlet water temperature δT is within a reasonable range, take down the water flow switch and reinstall it after cleaning. If the problem still cannot be solved, replace the water flow switch and restart the unit.			Auto Reset	No operation
S03	Water flow switch failure	After the system pump (P0) stops running and the water flow switch is detected to be closed for 5 minutes, unit will report a failure and be shut shown;		
Accessories and tools: water flow switch, water pumps, indoor PCB. multimeter. 1. Check if the water flow switch port is closed by jumper instead of cables of flow switch. If so, restore water flow switch wiring. If not, follow point 2. 2. Water flow switch checking: When unit is off or stops, pull the water flow switch cable out from the indoor PCB and use a multimeter (on/off) to check the water flow switch. If it's open, replace the indoor PCB, if it's closed, check the water flow switch further (Close the water pipe valve outside the unit, take out the water flow switch and check whether the water flow switch is stuck or damaged. If it cannot be repaired, then replace it). 3. External factors: Whether there is an external water pump working in the same water system. If so, the system water pump should be adjusted to synchronize it with the external water pump. (if the external water pump is running all the time).			Auto Reset	No operation
S04	Indoor unit communication failure	Whenever there is no communication between the operation panel and the indoor main PCB for 2 minutes, unit will report a failure and be shut shown;		
Accessories and tools: indoor main PCB, operation panel, multimeter 1. Confirm the situation of communication failure: If there is no communication as soon as the power is on, check according to 2.3.4; if the communication is normal after the power is on, but become abnormal after the outdoor unit starts, check whether there is a G cable with the A/B communication terminal of the outdoor unit. If yes, please connect the G line of the outdoor unit to the G port at the communication port of the indoor PCB, and then restart the unit. If the communication failure still exists, check whether the communication wire between the indoor and outdoor is separated from the strong power. 2. Wiring problem: According to the wiring diagram, check whether the A/B port of the communication line has been reversed or has poor contact. Use a multimeter (on/off gear) to test the communication line between the operation controller and the indoor PCB when unit is off; 3. Power supply problem: Check whether the power supply of the indoor PCB is normal (24VDC and the motherPCB has a blinking light); 4. Hardware problem: Replace with a new one;			Auto Reset	No operation

Code		Error		Analysis and Troubleshooting - Principle	
Analysis and Troubleshooting - Description				Manual Reset or Auto Reset	HP Operation During Error
S05	Outdoor unit communication failure	Whenever there is no communication between the operation panel and the indoor main PCB for 2 minutes, unit will report a failure and be shut shown;			
<p>Accessories and tools: outdoor control PCB, fan motor, operation panel, multimeter.</p> <ol style="list-style-type: none"> 1. Confirm the situation of communication failure, if there is no communication as soon as the power is on, check according to 2.3.4; if the communication is normal after the power is on, but become abnormal after the outdoor unit is running, then confirm whether there is a G on the A/B communication terminal of the outdoor unit, if yes, please connect the G line of the outdoor unit to the G port at the communication port of the indoor main PCB, and then restart the unit, if the communication failure still exists, check whether the communication wire in the indoor and outdoor is separated from the strong power, please contact the manufacturer. 2. Wiring problems: check whether the A/B port of the indoor and outdoor unit communication line has not been connected to the reverse or poor contact, use a multimeter (on and off gear), in the case of the unit power-off, short-circuit the A/B on one end and measure the connection on the other end, if the disconnection, then replace the communication line. 3. Power supply problem: Check whether the power supply of the outdoor PCB is normal (230VAC and the main PCB has a blinking light). 4. Disconnect the power, unplug the DC fan from the main PCB, and reapply the power to verify that the communication failure is not caused by a damaged motor. 5. Hardware problem with the operation panel itself, replace with a new one. 				Auto Reset	No operation
S06	Cooling outlet water temp. too low protection	In cooling mode, if TUO < 41°F unit will report a failure and be shut shown.			
<ol style="list-style-type: none"> 1. Restart operation, before displaying S06, confirm the inlet and outlet water temperature ΔT through the system diagram on the operation panel. If it is greater than 46°F, check whether the pump speed is setting to high speed (if it is low, adjust it to medium or high speed), and also check whether the filters in the water system are clogged or not. 2. Whether the set temperature is low (whether less than 18°F), during operation, observe the difference between the TC temperature and the outlet water temperature, if the outlet water temperature is more than 4°F lower than the TC, it is recommended that the set temperature be increased to more than 22°F to ensure that the outlet water temperature won't drop too low. 				Auto Reset	No operation
S07	Heating/DHW outlet water temp. too high protection	When compressor is working in heating or hot water mode, if the outlet water temperature is detected to be higher than the maximum permissible outlet water temperature of the heat pump, unit will report a failure and be shut shown., but the electrical heater can continue to work.			
<p>In hot water mode:</p> <ol style="list-style-type: none"> 1. Restart the unit, when S07 happens, check the inlet and outlet water temperature and water tank TW sensor value. If the inlet water temperature of the heat pump is higher than the TW value (normally, the TW is always higher than the inlet water temperature of the heat pump), the coil of the water tank can be too small which leads to the low heat exchanging capacity and causes S07. For temporary solution, the hot water ECO mode can be turned on to see if it is possible to alleviate the heat exchange problem of the water tank. If the problem can not be solved, it is necessary to replace the coil of water tank with a larger area as recommended. <p>Coexistence of heating and hot water modes.</p> <ol style="list-style-type: none"> 1. Observe the inlet and outlet water temperature δT of heat pump, if it is more than 14°F, please check whether the speed setting of the water pump is high speed. If it is low speed, please adjust it to medium or high speed. And at the same time, please check whether the filter in the water system is clogged; 2. Check the difference between the TC temperature and the outlet water temperature. If the temperature difference is more than 9°F (the outlet water temperature is higher than the TC), check whether the TC temperature sensor is installed in the middle or upper part of the buffer tank. 				Auto Reset	No operation
S08	Defrost three-time failure	When S09 (Defrost outlet water temp. too low protection) is triggered 3 times, unit will report a failure and be shut shown. This failure can not be recovered until repower.			
<ol style="list-style-type: none"> 1. If the ambient temperature is below 32°F and the water temperature is below 50°F, when the unit starts up and runs for the first time with defrost, water outlet temp can be too low can result in this protection. 2. Restart heating mode and observe the inlet and outlet water temperature δT during the heating operation. If it's more than 14°F and the set temperature is low (below 86°F), check whether the water pump speed is high speed (if it is low, please adjust to medium or high speed). Also check whether the filter is clogged in the water system. It is better to increase the set temperature to more than 90°F. 3. Check whether the unit is with heavy frost (evaporator frost thickness greater than 0,3" or ice fully covers), resulting in defrost time too long which cause the water temperature too low. In this case, manually remove the frost on the evaporator with hot water, and then check the cause of serious frost. 4. If the unit is newly installed, the distribution system is floor heating and fully open, it's recommended to close 2/3 of the water pipes of the floor heating to let the heat pump raise the water temperature as soon as possible. After the water temperature goes above 86°F, then open some more water loops. Keep this cycle constantly to raise the water temperature of heat pump to medium temperature. 				Manual Reset	No operation

Part 6 - Troubleshooting

Code	Error	Analysis and Troubleshooting - Principle	Manual Reset or Auto Reset	HP Operation During Error
Analysis and Troubleshooting - Description			Manual Reset or Auto Reset	HP Operation During Error
S09	Defrost three-time failure	During defrost, if TUO < 59°F, unit will report a failure and stop defrosting.		
		<ol style="list-style-type: none"> If the ambient temperature is below 32°F and the water temperature is below 50°F, when the unit starts up and runs for the first time with defrost, water outlet temp can be too low can result in this protection. Restart heating mode and observe the inlet and outlet water temperature δT during the heating operation. If it's more than 14°F and the set temperature is low (below 86°F), check whether the water pump speed is high speed (if it is low, please adjust to medium or high speed). Also check whether the filter is clogged in the water system. It is better to increase the set temperature to more than 90°F; Check whether the unit is with heavy frost (evaporator frost thickness greater than 0,3" or ice fully covers), resulting in defrost time too long which cause the water temperature too low. In this case, manually remove the frost on the evaporator with hot water, and then check the cause of serious frost; If the unit is newly installed, the distribution system is floor heating and fully open, it's recommended to close 2/3 of the water pipes of the floor heating to let the heat pump raise the water temperature as soon as possible. After the water temperature goes above 86°F, then open some more water loops. Keep this cycle constantly to raise the water temperature of heat pump to medium temperature. 	Auto Reset	No operation
S10	Water flow switch failure	When the unit has 3 consecutive S02 protection within 30 minutes, S10 will be reported.		
		Refer to the troubleshooting of water flow switch protection (S02).	Manual Reset	No operation
S11	Cooling anti-freeze failure	When the unit has 3 consecutive S01 protection within 30 minutes, S11 will be reported.		
		Refer to the troubleshooting of cooling anti-freeze protection (S01).	Manual Reset	No operation
S12	Floor preheating failure	During the operation of floor preheating, the running time of a certain stage exceeds the specified time, S12 will be reported and unit will exit preheating operation, while the unit can still operate in normal modes;		
		<ol style="list-style-type: none"> Check the recorded data of floor preheating to figure out where the anomaly is. Depending on the conditions of floor drying at site, choose if unit should run floor preheating again. Tc (Heating/cooling Temp. Sensor) installation position is not suitable which results in temperature reading deviation. Check whether the temperature difference between Tc (Heating/cooling Temp. Sensor) and the actual temperature is too much (over 4°F). 	Auto Reset	Normal operation
S13	4-way valve failure	When the 4-way valve detection function is turned on, in heating or hot water mode, after the unit is running for 10 minutes, unit will detect temperature difference between ambient temperature and outdoor coil temperature for 2 minutes. When the ambient temperature value is lower than outdoor coil temperature, the unit will be locked up with failure reported and cannot be recovered until repower;		
		<ol style="list-style-type: none"> When unit is off, check the value of ambient temperature and the outdoor coil temperature through the operation panel and confirm if they are of same value. If yes, follow the next steps. If not, use a hot wet towel or wet paper napkin wrapped around the ambient temperature sensor and check the change of ambient temperature through operation panel. If the ambient temperature remains without change while outdoor coil temperature changes, these two sensors can be connected oppositely. Please correct them according to the wiring diagram. Wiring Problems: According to the wiring diagram, check whether the wiring of 4-way valve coil is fine on PCB. When the unit is running for heating and the air blowing outdoor unit is hot, 4-way valve coil can be defective. Alternatively, by switching back and forth between the heating and the cooling modes (running for about 3 minutes in each mode), listen to the 4-way valve if there is a sound of "Da". If not, replace the 4-way valve coil. If yes, check the surface of 4-way valve whether it is uneven which may result in that pin of valve does not work. If so, the 4-way valve needs to be replaced. 	Manual Reset	No operation
S14	3-way valve failure	When the 3-way valve detection function is turned on, in heating or hot water mode, when Tc (Heating/cooling Temp. Sensor) or Tw (DHW Temp. Sensor) temperature value is higher than water inlet temperature for over 22°F, the unit will report a fault and be shut down.		
		<ol style="list-style-type: none"> Check and confirm if water connections of the heating and DHW are wrongly connected. Try to reverse the control signal lines of the 3-way valve which are for heating and DHW, then observe whether the unit will operate normally. Check and confirm if Tc (heating/cooling temp. sensor) and Tw (DHW temp. sensor) are connected oppositely. Pull out the Tw sensor from water tank and then hold it in hand and observe whether the hot water temperature sensor value follows the change. If the change is on Tc value instead of Tw, reverse the Tc and Tw sensor connections according to the wiring diagram. Check if the Tc or Tw sensors has fallen off, causing the inaccurate temperature reading. If yes, install the Tc or Tw sensor correctly. 	Auto Reset	No operation
S15	Reserved			
S16	Reserved			
S17	Reserved			
S18	Reserved			
S19	Reserved			
S20	Reserved			

Code		Error		Analysis and Troubleshooting - Principle	
Analysis and Troubleshooting - Description				Manual Reset or Auto Reset	HP Operation During Error
S21	Water flow failure	When the unit has 3 consecutive insufficient water flow protection (P23) within 30 minutes, S21 is reported and unit is shut down and cannot be startup unless re-power.			
Refer to the troubleshooting of insufficient water flow protection (P23).				Manual Reset	No operation
P01	Over current Protection	When the unit detects that the input current is higher than the value set by the Eeprom of the external machine, the unit will report a fault and shutdown for protection.			
Accessories and special tools: Multimeter This protection is generally caused by excessive system load. You can power on again and observe the operation of the unit: 1. If the temperature difference between the inlet and outlet water is greater than 14°F during operation, check whether the water pump speed is set to high speed (if it is low speed, please adjust to medium speed or high speed), and also check whether the filter in the water system is blocked; 2. If it is triggered in the hot water mode, you can confirm whether the domestic water tank coil is too small (the minimum heat exchange area is 3m ³). If it is too small, it may lead to low heat exchange capacity, so heat will continue to accumulate, and eventually due to The water temperature rises too fast and the current is too large. You can temporarily turn on the hot water ECO mode to see if it can alleviate the heat exchange problem of the water tank. If the hot water ECO mode cannot solve the problem, you need to replace the coil water tank with a larger coil area (at least 3m ³); 3. During operation, you can observe the difference between the inner coil temperature (TUP) and the outlet water temperature (TUO). Normally, the inner coil temperature is 2 to 4°F lower than the outlet water temperature. If TUP is higher than TUO, it may because the heat pump is unable to exchange heat, due to fouling of the plate changer. So the current rises and causes a fault, so as long as the plate changer is descaled and cleaned, the problem can be solved; 4. When triggered in cooling mode, you can check whether the evaporator is dirty or blocked or the heat island effect is caused by the installation position, resulting in high current. You can clean the evaporator, adjust the installation location, or install an discharge duct to eliminate the heat island effect; 5. The electronic control parameters are set incorrectly, resulting in false alarms of the unit. At this point you can try to upgrade the main PCB EEPROM settings. 6. Check whether the input voltage is normal. If it is lower than the rated voltage by more than 10%, the overcurrent protection may be triggered. Please contact the power supplier to adjust the power supply voltage.				Auto Reset	No operation
P02	Compressor phase current overload protection	When the driver PCB detects that the compressor phase current exceeds the compressor phase protection current value, the unit will report a fault and shutdown.			
Accessories and special tools: clamp meter, multimeter This protection is generally caused by excessive system load. You can power on again and observe the operation of the unit: 1. If the temperature difference between the inlet and outlet water is greater than 14°F during operation, check whether the water pump speed is set to high speed (if it is low speed, please adjust to medium speed or high speed), and also check whether the filter in the water system is blocked; 2. If it is triggered in the hot water mode, you can confirm whether the domestic water tank coil is too small (the minimum heat exchange area is 3m ³). If it is too small, it may lead to low heat exchange capacity, so heat will continue to accumulate, and eventually due to The water temperature rises too fast and the current is too large. You can temporarily turn on the hot water ECO mode to see if it can alleviate the heat exchange problem of the water tank. If the hot water ECO mode cannot solve the problem, you need to replace the coil water tank with a larger coil area (at least 3m ³); 3. During operation, you can observe the difference between the inner coil temperature (TUP) and the outlet water temperature (TUO). Normally, the inner coil temperature is 2 to 4°F lower than the outlet water temperature. If TUP is higher than TUO, it may because the heat pump is unable to exchange heat, due to fouling of the plate changer. So the current rises and causes a fault, so as long as the plate changer is descaled and cleaned, the problem can be solved; 4. When triggered in cooling mode, you can check whether the evaporator is dirty or blocked or the heat island effect is caused by the installation position, resulting in high current. You can clean the evaporator, adjust the installation location, or install an discharge duct to eliminate the heat island effect; 5. The electronic control parameters are set incorrectly, resulting in false alarms of the unit. At this point you can try to upgrade the main PCB EEPROM settings. 6. Check whether the input voltage is normal. If it is lower than the rated voltage by more than 10%, the overcurrent protection may be triggered. Please contact the power supplier to adjust the power supply voltage.				Auto Reset	No operation
P03	IPM module protection	During compressor operation, the IPM module is detected to be over-temperature protected (the protection value is generally 203-212°F) or over-current protected, and the unit reports a fault and shutdown;			
Accessories and special tools: clamp flow meter. Multimeter 1. Refer to the P02 troubleshooting method. 2. In cooling mode, please check whether the fan is running normally (whether the speed is low, such as below 500 rpm) or only one fan is running in the dual fan system, if yes please refer to the handling of fan failure, check and replace the motor if needed. If the speed is low, contact the manufacturer for further investigation; 3. In cooling mode, you can check whether the evaporator is dirty or blocked or the heat island effect is caused by the installation position, resulting in high current. You can clean the evaporator, adjust the installation location, or install an discharge duct to eliminate the heat island effect; 4. Change drive PCB.				Auto Reset	No operation

Part 6 - Troubleshooting

Code	Error	Analysis and Troubleshooting - Principle	Manual Reset or Auto Reset	HP Operation During Error
Analysis and Troubleshooting - Description			Manual Reset or Auto Reset	HP Operation During Error
P04	Reserved			
P05	High pressure switch protection	Fault shutdown is reported when a high pressure switch port disconnection is detected for 5 seconds after the compressor has been started for 1 minute.		
		<ol style="list-style-type: none"> Please check error history to see if the high pressure value is higher than 42 Bar when unit report this error; if so, please check the value of high pressure sensor (please refer to High Pressure Sensor Failure section for description). If the most recent HV protection was less than 41 bar, the HV pressure sensor may be faulty, try replacing the HV switch. Check if there is insufficient heat dissipation on the high-pressure side (condensing side) Data recording, after confirming the temperature difference between the inlet and outlet water, shut down and repower the unit. Then the following judgments are made: <ol style="list-style-type: none"> Confirm that the temperature difference between the water inlet and outlet is within 9°F, if it exceeds 14°F, please check whether the water pump is set to low speed, if yes please try to let the water pump run at medium or high speed, to ensure that the water flow is within the normal range; Also please check the filters in the water system, whether there is a dirty blockage, and then clean it; Confirm the temperature difference between the outlet water temperature and the TC temperature or TW temperature. Normally, the outlet water temperature will be 5 to 9°F higher than the TC or TW, if it is more than 9°F, please check whether the installation position of the TC and TW sensors is installed in an inappropriate position, the TC or TW should be installed in the middle and upper part of the water tank as far as possible; During the operation of the unit, observe whether the temperature of the inner coil is higher than the temperature of the outlet water. If the temperature of the inner coil is higher than the temperature of the outlet water by more than 5°F, check if there is fouling of the plate changer. As long as the plate changer is descaled and cleaned, the problem can be solved; there is scaling in the plate exchange, and it is necessary to clean the water side of the plate exchange to remove the scale; If it occurs in cooling mode, please check for poor ventilation around the unit, you can compare the value between ambient temp. Sensor and real ambient temp, if the difference between the two values is more than 9°F, there may be poor ventilation, and you can consider adding an air guide to the unit. So that hot air can be vented in a timely manner; Please check if evaporator is blocked by dirt, clean the evaporator. If all of above solutions can not solve the problem, the EEV may be abnormal, please refer to the "EEV troubleshooting section". 	Auto Reset	No operation
P06	High pressure overpressure protection	If the high pressure is higher than the system pressure protection value after the compressor has been started for 1 minute, the unit will report faulty shutdown protection;		
		<ol style="list-style-type: none"> Determine if there is insufficient heat dissipation on the high-pressure side (condensing side). After recording the data and confirming the temperature difference between the inlet and outlet water and the outlet water temperature at the time of the unit's protection shutdown, power down and restart the unit to allow the unit to run again, and make the following judgments during the operation process: <ol style="list-style-type: none"> Confirm that the temperature difference between the inlet and outlet water of the unit is within 9°F, if it exceeds 14°F, please check whether the running gear of the water pump is set to low speed, and try to let the water pump run at medium or high speed to ensure that the water flow is within the normal range; check the filters in the water system, whether there is a dirty blockage, and then clean it; Confirm the temperature difference between the outlet water temperature of the unit and the TC temperature or TW temperature, under normal circumstances, the outlet water temperature will be 5 to 9°F higher than the TC or TW, if it is more than 9°F, please check whether the installation position of the TC and TW sensors is checked off or installed in an inappropriate position, the TC or TW should be installed in the middle and upper part of the water tank as far as possible; During the operation of the unit, observe whether the temperature of the inner coil is higher than the temperature of the outlet water. If the temperature of the inner coil is higher than the temperature of the outlet water by more than 5°F, there is scaling in the plate exchange, and it is necessary to clean the water side of the plate exchange to remove the scale; If it occurs in cooling mode, check for poor ventilation around the unit, check the evaporator of the outdoor unit for dirt and blockage, and clean debris from the outdoor heat exchanger; Check for poor ventilation around the outside unit, compare the outdoor temperature sensor display and the measured outdoor temperature on site to see if there is a big difference, if the difference between the two is more than 9°F, there may be poor ventilation, and you can consider adding an air guide to the unit. Circle so that hot air can be vented in a timely manner; If the above troubleshooting is unable to solve the problem, the EEV may be abnormal, please refer to the "EEV troubleshooting section". 	Auto Reset	No operation
P07	Initial power-up preheat protection	When the unit is powered on, if the ambient temperature is lower than 23°F, the unit will warm up for 30 minutes, report the protection, system will turn on the compressor electric heat tape, and the unit will not be allowed to turn on.		
		There is no need to deal with it, just leave the unit to warm up for 30 minutes, but with the current version of the program, the line controller will not report a P07 fault;	Auto Reset	No operation

Code		Error		Analysis and Troubleshooting - Principle	
Analysis and Troubleshooting - Description				Manual Reset or Auto Reset	HP Operation During Error
P08	High discharge temperature protection	When the discharge temperature is higher than value of protection shutdown point (generally between 230°F and 239°F) during unit operation, the unit will report a malfunction shutdown;			
Accessories and special tools: discharge temperature sensor, refrigerant, refrigerant leak detector, pressure gauges, electronic scale, multimeter 1. Examine the factors of insufficient refrigerant: 1.1. Under the standby mode which longer than 30 mins, check the refrigerant pressure value, and confirm whether there is serious leakage of refrigerant quantity initially. The judgment way is: whether the saturation temperature corresponding to the pressure value currently displayed, is the same as the ambient temperature, and if it is lower than the ambient temperature by more than 9°F, it can be judged that there is a leakage of refrigerant basically; 1.2. For split units, check whether the refrigerant piping exceeds 15 meters and the refrigerant is not replenished; if so, replenish the refrigerant according to the length of the piping; 1.3. You can try to start the machine, and observe the change of low pressure, if the low pressure is too low (i.e. the evaporating temperature is lower than the ambient temperature by more than 18°F), and the running time is more than 5 minutes, you can initially judge that it is suspected that the refrigerant is leaking, and you can temporarily add approx. 100-200g of refrigerant to see whether the low pressure of the system is rising or not. And whether the discharge temperature is dropping. If so, you can find the leakage point in the unit, and make up for the leakage. Re-evacuate the unit and refill the refrigerant according to the refrigerant quantity on the nameplate; 2. Examine the factors of insufficient heat transfer. Please check the error history, if there is no high pressure protection, the effect of poor heat exchange can be ruled out. 3. Sensor problem: Pull out the sensor from the PCB, and use a multimeter to test the function of the resistance, measure the resistance of the sensor, and compare with the table of 50K temperature - resistance table, if there is a large deviation, then replace the discharge temperature sensor; 4. If the above troubleshooting fails to solve the problem, the EEV of the refrigerant system may be abnormal, please refer to "EEV troubleshooting section".				Auto Reset	No operation
P09	Outdoor coil over-temperature protection	In the cooling mode, the external coil temperature is higher than the external coil over-temperature protection value (usually around 144°F), then the unit reports a fault and shutdown.			
Accessories and Specialized Tools: Motors 1. In cooling mode, please confirm whether the fan motor is running normally (whether the speed is low, such as less than 500 rpm) or only one fan is running in the dual fan system. If yes, please refer to the solution of fan motor failure, investigate and replace the motor. If the speed is low, please contact the manufacturer for further investigation. 2. In cooling mode, you can check whether the evaporator is dirty or blocked or the heat island effect is caused by the installation position, resulting in high current. You can clean the evaporator, adjust the installation location, or install an discharge duct to eliminate the heat island effect.				Auto Reset	No operation
P10	Input voltage over-under-voltage protection (only for single-phase units)	When the unit is energized (either running or standby) and the input voltage is detected to be lower than 140V or higher than 270V, the unit will report a fault and shutdown;			
Accessories and special tools: main PCB, fan motor, multimeter 1. Using a multimeter, measure whether the voltage between LN line is normal nor not, and the voltage range of the single phase unit should be in the range of 140V-270V. 2. Disconnect the power, unplug the DC fan from the PCB, and then re-power to confirm whether the voltage detection abnormality is caused by the damage of the motor. If the fault is cleared, then replace the DC fan, if the fault is not cleared, then replace the main PCB.				Auto Reset	No operation
P11	Ambient temperature over range shutdown protection	Heating mode: when the ambient temperature is lower than -13°F, or the ambient temperature is higher than 113°F, the unit will report a fault and shutdown. Cooling mode: when the ambient temperature is lower than 46°F, or the ambient temperature is higher than 149°F, the unit will report a fault and shutdown.			
Accessories and special tools: ambient temperature sensor, multimeter 1. Through the multimeter, test if the ambient temperature sensor resistance value corresponding to temperature resistance table, if there is a deviation, then replace the sensor. 2. Confirm whether the current actual ambient temperature reaches the limitation point of heat pump ambient temperature. If so, please wait for the ambient temperature reach to a normal range, and the unit will back to normal. 3. Check whether the installation position of the ambient sensor is blocked by ice or exposed to direct sunlight, if so, please protect the ambient temperature sensor, to prevent icing or exposure to direct sunlight. 4. Check whether there is any heat island effect (cold island effect) in the installation position of the unit, and adjust the installation position or install an discharge duct to eliminate the heat island or cold island effect.				Auto Reset	No operation

Part 6 - Troubleshooting

Code	Error	Analysis and Troubleshooting - Principle	Manual Reset or Auto Reset	HP Operation During Error
Analysis and Troubleshooting - Description			Manual Reset or Auto Reset	HP Operation During Error
P12	Environmental frequency limiting protection (EFLP)	When the unit detects that the heat pump is not allowed to run the highest frequency at the current ambient temperature, the outdoor unit will feedback the ambient frequency limit flag bit, but the unit will still run normally, and the unit will not display this error code.		
This error will not show in display, but if target water temperature have a big difference with real water temperature, and unit could not running in high speed, you can consider if it because the ambient temperature is too high, so frequency is limited. You can confirm the accuracy of the ambient temperature check according to the troubleshooting of P11.			Auto Reset	No operation
P13	Low pressure switch protection	When the unit has been up and running for 3 minutes, if a low voltage switch disconnection is detected, a fault is reported.		
Accessories and specialized tools: short cables, main PCB. According to F11 low pressure checking this error, since the unit does not have low pressure switch, this protection does not normally occur. If it does, follow the wiring diagram to check whether the reserved input port has not been shorted, resulting in a false alarm.			Auto Reset	No operation
P14	Reserved			
P15	Reserved			
P16	Refrigerant leak	When equipped with refrigerant leakage detection function, if refrigerant leakage is detected, reported the P16 , the unit will be stop,		
Accessories and tools: refrigerant leakage detector. main PCB. multimeter. 1. When unit is in Off state, check the refrigerant pressure value in standby state through operation panel(standby time should more than 30 minutes),to confirm whether there is a serious leakage of refrigerant first.The judgment: whether the saturation temperature that corresponding to the current displayed refrigerant pressure value is the same as the ambient temperature, and if the refrigerant pressure value is lower than the ambient temperature by more than 9°F, then can judge that there is a leakage of refrigerant basically; 2. Check whether the refrigerant system have leakage problem, use refrigerant leakage detector, check inside the compressor cabinet, check if the refrigerant detection box have leakage alarming, if so, can double check where the leakage point is, if not, carry out the check in step 3; 3. Replace the refrigerant detector(sensor), and then repower the unit, to analyze the way according to step 4; 4. Observe the change of low pressure, if the low pressure is too low (i.e. the evaporating temperature is lower than the ambient temperature by more than 18°F), and the operation time of the unit is more than 5 minutes, it can judge there is a leakage point. Can temporarily supplemented with 100-200g refrigerant to see if the low pressure will have rebound, if so, re-vacuum the unit and re-inject the refrigerant according to the refrigerant amount on the nameplate;			Auto Reset	No operation
P17	Inlet and Outlet Water Temperature Difference Protection	When the temp difference between the inlet and outlet temperatures exceed the threshold of 22 degrees		
1. Ensure water flow is sufficient/pump sizing/pipe sizing etc.. If not, please repair accordingly. 2. Ensure temp sensors are properly located and attached properly. Verify accurate readings with known temperature sensors. If needed, replace/repair. 3. Check for proper pressure in refrigerant system (verify pressures or within acceptable limits). If pressures are not within acceptable limits- see low/high pressure faults. 4. Call technical support.			Auto after 3 minutes and temp difference is corrected	Compressor is disabled No operation
P18	Low pressure protection	When the unit detects that the low pressure value is lower than the protection value during operation, the unit will shut down and report a fault.		
Accessories and tools: refrigerant, leakage detector, pressure gauge, vacuum pump: 1. When unit is off, read refrigerant pressure value from display (unit should stay standby >30min) for first judgement if serious leakage happens. If saturation temperature corresponding to the displayed refrigerant pressure is at same level of ambient temperature, it is fine. If it is lower than ambient temperature for more than 9°F, leakage could happen. 2. Start the unit and observe the change of low pressure. If the low pressure is too low (i.e., the evaporating temperature is lower than the ambient temperature by more than 18°F), and the running time is more than 5 minutes, it can be preliminarily judged as a potential leakage. Fill about 100 to 200g to see whether the low pressure of the system is increased. If yes, proceed leakage test on the system. After finding out leakage point and fixing it, vacuum the heat pump system. Then recharge the unit with correct amount of refrigerant based on info from nameplate.			Auto Reset	No operation
P19	Reserved			
P20	Reserved			
P21	Reserved			
P22	Reserved			

Code		Error		Analysis and Troubleshooting - Principle	
Analysis and Troubleshooting - Description				Manual Reset or Auto Reset	HP Operation During Error
P23	Insufficient water flow protection	When the water flow is detected to be less than the minimum flow rate (1080L/h for 15KW), the unit will report a fault and shutdown.			
Accessories and special tools: water flow sensor. Main PCB. Multimeter 1. Check if the system displays a water flow value that is near or less than the minimum allowable water flow while the pump is running, if yes please check the reasons of insufficient water flow, and find the related solution. 1.1. Check that the water system is completely emptied, if the water pressure is above 2 bar, if all valves are opened, if the filter is clogged. 1.2. Check that the water pump operates normally, and water flow is in the correct direction after switching on. 1.3. In running condition, wait for the compressor run for 5 minutes, if the water inlet and outlet temperature difference is in a reasonable range, then remove the water flow sensor, clean it and reinstall it, then restart the unit to exclude the possibility of foreign objects interfering with the detection of the water flow sensor. If the problem still cannot be solved, replace the water flow sensor and restart the unit. 2. If the water flow display value is 0, then check whether the water flow sensor is not contact well; If it is ok, and find the terminal of water flow sensor according to the wiring diagram. Under the condition of uninterrupted power supply, then use a multimeter (DC level), measuring the water flow sensor power supply is 24V or not. When the water pump is running, the water flow sensor feedback voltage is higher than 0. If yes, then if the supply of water flow is not 24V, if yes then replace the indoor PCB. If the water flow sensor feedback voltage is equal to 0, pull out the water flow sensor cable from the water flow sensor body, and measure whether the terminals at both ends of the connecting wire are on or not. If not, replace the cable; If yes, change the water flow.				Auto Reset	No operation
P24	Reserved				
P25	Reserved				
P26	Reserved				
P27	Reserved				
P28	Anti-Legionella	When the unit enters anti-legionella,, if the water temperature in the water tank does not reach the anti-legionella target temperature within the set time, a protection will be reported. At this time, the user can click to choose whether to re-enter anti-legionella or cancel and wait for the next sterilization.			
1. Check whether the hot water temperature sensor has fallen off, causing inaccurate temperature detection; 2. The unit is not equipped with electric heating or other heat sources to heat the water to the anti-legionella temperature.				Auto Reset	Normal operation

Table 23 - Error codes

Part 6 - Troubleshooting

6.2 Troubleshooting 1

Troubleshooting of non-heating, high power consumption, and high exhaust temperature

Fault category	Main reasons	Breakdown of reasons	Checkpoints	Treatment program
High power consumption, long running times, not suitable heating	Problems matching for the unit and terminals	The house has a lot of space and poorly insulated exterior walls.	Review of selection	Enhanced insulation
		The heating end is small, resulting in the house failing to meet the heating standard when the water temperature is set low; or when the water temperature is set high, the unit starts and stops frequently, resulting in high power consumption.	Review of selection	Increase the terminals heating area
		Floor heating	Initial use, high water content in underfloor heating Underfloor heating hasn't been cleaned for a long time	1. Run the "underfloor heating first heat function" 2. Cleaning the underfloor heating system
	Problems with auxiliary heat sources	Unreasonable setting of auxiliary heat source	1. Whether the integration time of the heating auxiliary heat source is set too high or too low. 2. Whether the turn-on time of the hot water auxiliary heat source is set too high or too low. -Setting it too high and at low temperatures, it does not replenish the heat source in time, resulting in no heating temp increase; -Setting it too low, the heat source turns on early at medium to high temperatures, resulting in high power consumption.	Adjust the calculated value according to the actual temperature rise of the unit
	Problems with the heating curve function	Heating curve parameters are not set properly	1. The heating curved water temperature setting is low, resulting in water temperatures that do not reach the desired heating temperature; 2. The water temperature setting of the heating curve is high, which leads to high water temperature for a long period of time and brings high power consumption.	Optimally adjust the water temperature and ambient temperature settings of the heating curve function according to the actual heating and thermal insulation of the house
	Defrost Abnormal (Excessive defrost time)	Outdoor coil temperature sensing inaccuracy	1. Check the sensor mounting location for the presence of no frost 2. Detect if the sensor is loose	1. Check to see if the outdoor coil temperature is growth slowly or not during unit defrost operation, try changing the outdoor coil temperature sensor position; 2. Defrost time exceeds 8 minutes and the coil temperature does not reach the temperature exit point and there is a high pressure pressure bias for high (R32-36bar,R290-26bar) conditions, try troubleshooting for a loose or a temperature sensing head for external coil temperature sensor.

Fault category	Main reasons	Breakdown of reasons	Checkpoints	Treatment program
High power consumption, long running times, not suitable heating	Defrost Abnormal (does not enter defrost)	The conditions are not met.	Outdoor coil temperature sensor problems	1. Loose or abnormal sensor 2. Outdoor coil temperature sensor in wrong position with other sensors
			Frequent starts and stops (running time less than 5 minutes)	Check the TC temperature sensor installation position whether there is a temperature sensing inaccuracy, sensor installation position adjustment.
			Evaporator refrigerant flow path distribution abnormality	Observe the evaporator frost situation, whether there is uneven frost phenomenon, especially the position of where coil temp sensor installed, whether there is no frost situation, if so, the coil temp sensor position to move to the frost serious coil position.
	Defrost Abnormal (does not enter defrost)	The conditions are not met.	Multi-unit defrosting allows control of logical limitations	In the system, only 1/3 of the units are allowed to defrost at the same time, and when more than 1/3 of the units have a need for defrosting, the system will limit the number of defrosting units, if the unit can enter defrosting after a short wait, it is a normal situation.
	Defrost Abnormal (not fully defrost)	Uneven frost formation	Abnormal distribution of refrigerant flow path in evaporator	Observe the frosting situation of the evaporator of the unit to see if there is uneven frosting, especially on the circuit where the outer coil temp sensor is installed. If so, move the position of the outer coil temp sensor to a circuit that is severely frosted and cannot be cleaned; (Analysis of frost formation in the unit, as shown in the figure)
			Confirm the evaporator coil temperature when exiting defrosting	During the defrosting operation of the unit, observe the evaporator defrosting situation when the coil temperature reaches the exit temperature. If there is still a large portion of defrosting left, try increasing the exit coil temperature setting value, such as 20 degrees or 25 degrees.
			1. The coil of the 4-way valve itself is damaged 2. The 4-way valve is stuck and cannot be reversed	1. Check if the coil of the 4-way valve is disconnected or burnt out 2. Check if the 4-way valve has gas leakage
			First defrosting with low ambient temperature and water temperature during initial operation	Close the 2/3 end heating terminals, then allow the water temperature in the buffer water tank to rise above 30 degrees before slowly opening the end heating terminals for heating operation.
			1. Insufficient water volume in the system, such as a radiator or fan at the end without a buffer water tank 2. Check if the temperature set by the controller is too low, such as below 30 degrees Celsius	1. Add buffer water tank 2. Increase the set temperature to above 90°F.
	Defrost Abnormal (defrost failed)	First installation, operating at low ambient and water temperatures	During the first defrosting cycle, the water temperature is too low	After closing most of the end terminals, the machine can be restarted to increase the water temperature of the buffer tank as soon as possible. After the increase, the other end terminals can be slowly opened in batches to reduce the impact of the ends on the water temperature.

Part 6 - Troubleshooting

Fault category	Main reasons	Breakdown of reasons	Checkpoints	Treatment program								
High power consumption, long running times, not suitable heating	Defrost Abnormal (defrost failed)	Excessive difference in inlet and outlet water temperature	<ol style="list-style-type: none"> The filter is dirty and blocked, causing excessive inlet and outlet temperature The water pump is set to work in low speed, causing a big difference in inlet and outlet water temperature 	<ol style="list-style-type: none"> Clean the filter in the water system again Set the water pump to high speed working 								
		Inaccurate detection of outdoor coil temperature sensor	<ol style="list-style-type: none"> Check if the sensor position if without frost Check if the sensor is loose 	<ol style="list-style-type: none"> During the defrosting operation of the unit, observe whether the coil temperature change slow or not, and try changing the temperature position of the coil temp sensor. If the defrosting time reaches 10 minutes and the coil temperature does not reach the temperature exit point, and there is a high pressure (36bar, R290 is 26bar), try to investigate the looseness of the outer coil temperature 								
	Defrost Abnormal (frequent defrosting)	Low ambient temperature and high ambient humidity	Normal phenomenon	No processing required								
		At about 0 degrees ambient temperature, the unit is defrosted regularly, i.e., the defrost cycle is 50 minutes.	Normal phenomenon	For the ambient temperature of about 0 degrees, the unit does not have a serious case of frost, you can turn off the timed defrost function in this interval, and change it to intelligent defrosting mode.								
	The mainframe has not reached the frequency reduction point, but is operating at a limited frequency	Ambient temperature cause limited frequency operation	<ol style="list-style-type: none"> Confirm whether the current ambient temperature of the unit is the frequency limit zone (detecting ambient temperature higher than 11 degrees above but the actual ambient temperature is not that high) 	Check to make sure that there is no deviation between the ambient temperature detected by the unit and the actual ambient temperature (The frequency will be limited when the unit detects that the ambient temperature is higher than 20°F).								
		Exhaust gas temperature over high limit frequency protection	Through the controller, check if the unit exhaust temperature triggers the frequency limit protection	If the current exhaust temperature is greater than the protection values in the table below, if so, refer to P08 in error code list. <table border="1" data-bbox="1134 1391 1466 1532" style="margin: 10px auto;"> <thead> <tr> <th colspan="2">Exhaust limit value</th> </tr> <tr> <th>Models</th> <th>R32</th> </tr> </thead> <tbody> <tr> <td>NHP32-036</td> <td>207°F</td> </tr> <tr> <td>NHP32-060</td> <td>216°F</td> </tr> </tbody> </table>	Exhaust limit value		Models	R32	NHP32-036	207°F	NHP32-060	216°F
		Exhaust limit value										
	Models	R32										
NHP32-036	207°F											
NHP32-060	216°F											
High pressure frequency-limiting protection	Via the controller, see if the unit's high-pressure pressure triggers the frequency-limiting protection	If the current high pressure value is greater than the protection value in the following table, if so, please refer to P06 in error code list. <table border="1" data-bbox="1134 1704 1466 1845" style="margin: 10px auto;"> <thead> <tr> <th colspan="2">High-pressure limit values</th> </tr> <tr> <th>Models</th> <th>R32</th> </tr> </thead> <tbody> <tr> <td>NHP32-036</td> <td>37bar</td> </tr> <tr> <td>NHP32-060</td> <td>36bar</td> </tr> </tbody> </table>	High-pressure limit values		Models	R32	NHP32-036	37bar	NHP32-060	36bar		
High-pressure limit values												
Models	R32											
NHP32-036	37bar											
NHP32-060	36bar											

Fault category	Main reasons	Breakdown of reasons	Checkpoints	Treatment program								
<p>High power consumption, long running times, not suitable heating</p>	<p>The mainframe has not reached the frequency reduction point, but is operating at a limited frequency</p>	<p>Refrigeration anti-freezing frequency limit protection</p>	<p>With the controller, see if the unit's low pressure triggers the frequency limit protection</p>	<p>If the current low pressure value (corresponding to the evaporating temperature) is less than the protection value in the following table, if so, refer to S01 in error code list.</p> <table border="1" data-bbox="1129 389 1465 568"> <thead> <tr> <th colspan="2" data-bbox="1129 389 1465 456">Refrigeration anti-freezing evaporating temperature</th> </tr> <tr> <th data-bbox="1129 456 1297 495">Models</th> <th data-bbox="1297 456 1465 495">R32</th> </tr> </thead> <tbody> <tr> <td data-bbox="1129 495 1297 533">NHP32-036</td> <td data-bbox="1297 495 1465 533">39°F</td> </tr> <tr> <td data-bbox="1129 533 1297 568">NHP32-060</td> <td data-bbox="1297 533 1465 568">39°F</td> </tr> </tbody> </table>	Refrigeration anti-freezing evaporating temperature		Models	R32	NHP32-036	39°F	NHP32-060	39°F
		Refrigeration anti-freezing evaporating temperature										
Models	R32											
NHP32-036	39°F											
NHP32-060	39°F											
<p>Low noise mode</p>	<ol style="list-style-type: none"> 1. Verify that the unit is operating in low noise mode 2. Confirm that the frequency gear setting for the low noise mode is not too low 	<ol style="list-style-type: none"> 1. If low noise mode operation is not required at this time of the day, turn low noise mode off or adjust the low noise mode timer operation time period; 2. The gear of the limit in the low noise mode can be increased appropriately; 										
<p>High exhaust temperature protection</p>	<p>Refrigerant leakage Insufficient refrigerant</p>	<ol style="list-style-type: none"> 1. Leakage due to poor solder joints. 2. Transportation irregularities lead to cracked copper pipes. 3. Split unit refrigerant pipe connection port leakage. 4. Improper use causes heat exchanger to freeze up. 	<ol style="list-style-type: none"> 1. Electronic leak detector for leak detection 2. If all the refrigerant in the system leaks, a small amount of refrigerant needs to be filled for leak detection 	<ol style="list-style-type: none"> 1. Find the leakage point 2. After the leak detection is completed, recover the residual refrigerant in the system 3. Repair welding (nitrogen filling protection). If the refrigerant pipe connection port leaks, remake the refrigerant pipe connection port and tighten the nut according to the operating specifications 4. Add refrigerant according to the refrigerant filling amount on the nameplate. 								
	<p>After maintenance</p>	<ol style="list-style-type: none"> 1. Welding beryllium oxide or foreign objects blocking the refrigerant filter. 2. Moisture enters the refrigerant system during maintenance. 	<ol style="list-style-type: none"> 1. Weld down the electronic expansion valve assembly and check for any dirt or blockage. 2. Replace the filter. 	<ol style="list-style-type: none"> 1. Welding (nitrogen filled protection). 2. Vacuum, after the vacuum pressure is below -0.1bar, continue to vacuum for more than 30 minutes. 3 Add refrigerant according to the refrigerant filling amount on the nameplate. 								
	<p>Problems with water system</p>	<ol style="list-style-type: none"> 1. Insufficient water flow leads to a large temperature difference between inlet and outlet water 2. Dirty water-side filter clogging 3. Poor heat transfer due to air into the water system 4. Heat exchanger scaling due to poor water quality 	<p>Check the water system</p>	<ol style="list-style-type: none"> 1. Drain the water inside of unit 2. Clean the filter 3. Scale removal and cleaning of water system 4. Fill with softened or purified water 								

Part 6 - Troubleshooting

Fault category	Main reasons	Breakdown of reasons	Checkpoints	Treatment program
High exhaust temperature protection	Control issues	1. Exhaust sensor resistance failure, resistance drift. 2. Incorrect setting of exhaust protection parameter values . 3. Main and auxiliary valve regulation failure. 4. Severe frost formation and prolonged non frost formation.	1. Check the exhaust temperature sensor. 2. Check the Eeprom parameters of the outdoor unit. 3. The output ports of the main and auxiliary valves on the main PCB are damaged. 4. The coil or valve body of the electronic expansion valve is damaged.	1. Check the exhaust temperature sensor. 2. Check the Eeprom parameters of the outdoor unit. 3. The output ports of the main and auxiliary valves on the main PCB are damaged. 4. The coil or valve body of the electronic expansion valve is damaged.
	Installation issues	1. Poor installation environment leads to dirty and blocked outdoor heat exchanger 2. Poor heat exchange caused by improper installation position and lack of ventilation 3. Failure to place TC and TW sensors as required resulted in control deviation.	Troubleshooting according to the installation requirements in the manual	1. Clean the debris from the outdoor heat exchanger. 2. Relocation that does not meet installation specifications to ensure ventilation requirements. 3. If it is not possible to move the machine, install a guide air duct.

Table 24 - Troubleshooting

EEV troubleshooting

6.3 Troubleshooting 2

Abnormal system performance

For example: when the outlet water temp. is 30°C, if the discharge temp. is only 40°C, which is low.

Condensing temp. = corresponding saturation temp. under condensing pressure, calculated by measuring the high pressure side and looking up the table (can be estimated by outlet water temp. -3°C)
Normally the discharge superheat is 15-40K

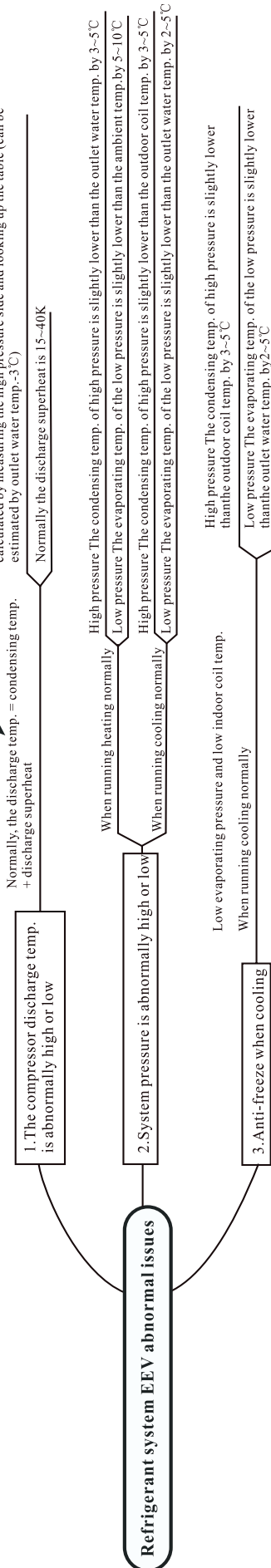

Related troubleshooting 1

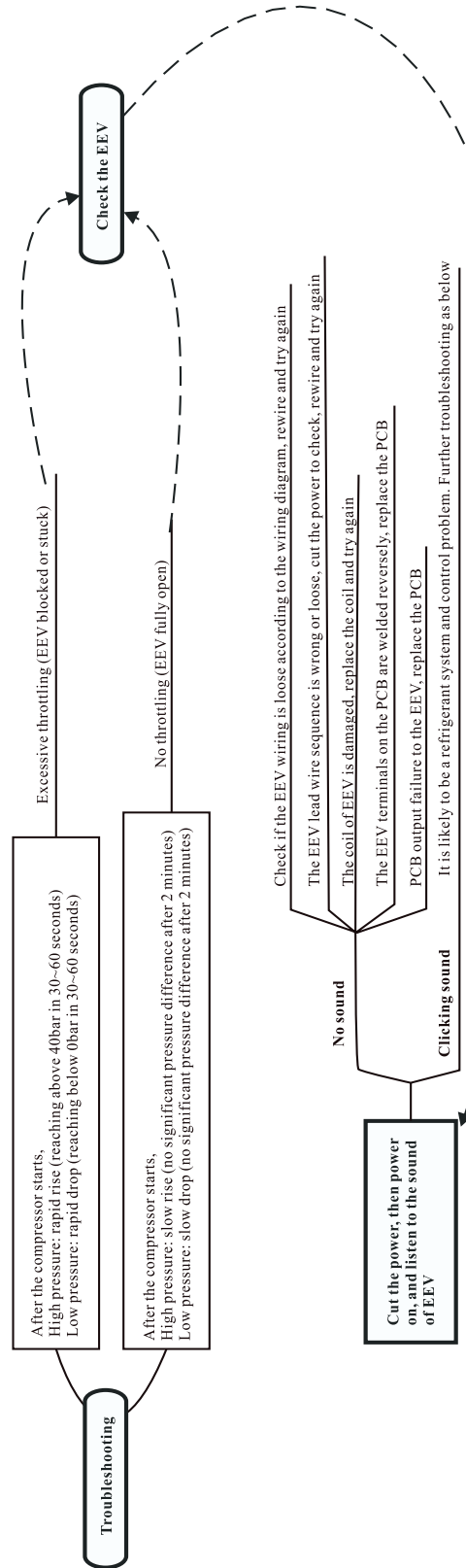

EEV troubleshooting

Related troubleshooting 2

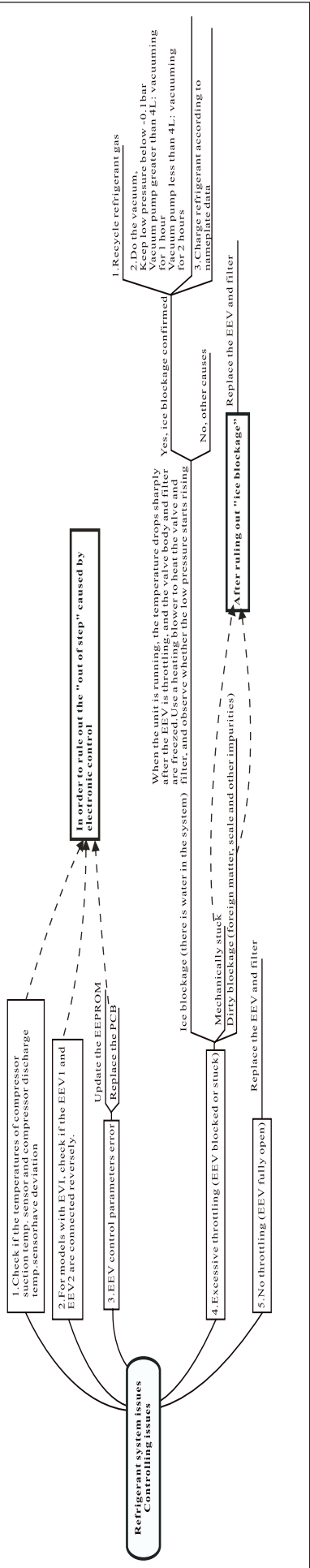

7.1 Precaution of maintenance for units with flammable refrigerant (R32):

! WARNING

All inspections and maintenance shall be performed while the unit is powered down, unless the inspection part requires power applied.

1) Service area and personnel requirements.

All service technicians/personnel should be trained to maintain these products before any maintenance is being done. The service area of the units should not be enclosed and must have proper ventilation. All loose combustible materials should be removed from the area.

***The following content needs to be operated by the designated personnel of the supplier.**

*When the ambient temperature is lower than 43°F, enter the first level of anti-freeze, stop N minutes, open one minute, cycle running water pump. When the ambient temperature is lower than 39°F and the inlet water temperature is lower than 41°F, it enters the second level of anti-freezing and starts the heat pump running; when the inlet water temperature rises to 54°F or the ambient temperature reaches 43°F, it exits the second level of anti-freezing and the heat pump stops running. When the ambient temperature is higher than 43°F, exit all anti-freezing.

2) Monitor status of refrigerant

During the service and maintenance of the equipment, the refrigerant system should be monitored to alert any service personnel of a leak during service.

3) Storage of fire extinguishers

When hot-working treatment is needed for heat pump system or related components, ensure fire extinguisher is placed nearby. The proper fire extinguisher should be type of dry powder or carbon dioxide.

4) Prohibition of fire

Conduct safety inspections at service area to ensure that there is no flames and potential ignition sources (including smoke) and remove all combustible materials from the area.

5) Equipment inspection

If electrical components are to be replaced, they should be installed in accordance with intended use and correct operating regulations.

6) Inspection of electrical elements

The service on electrical components should include general security check and inspection of electrical elements. If a defect that could threaten personal safety is found, the appliance should be locked out until the defect is properly solved.

7) Inspection of electrical cables

Check the status of cables and verify if any defects happen because of abrasion, corrosion, overpressure, vibration, cut by sharp edges or other reasons. This inspection should also consider the effects because of cable aging and continuous vibration of compressor and the fans.

8) Inspection of flammable refrigerants

Inspection of refrigerant leakage should be carried out in service area without fire or any other potential ignition source. And this inspection should not be done by detectors working with ignition, such as halogen probe.

If a leak is suspected, all flames should be removed from service area or extinguished.

If a repair is required by the use of flame (solder, braze etc..) the service personnel must recover all refrigerant prior to the repair. During the repair, oxygen-free nitrogen must be flowing through the refrigerant system to ensure longevity and proper function of the system.

9) Procedures of service on refrigeration system

The refrigeration circuit should be operated according to the proper procedures. And the flammability of refrigerant should also be considered. Please follow the procedures below.

- Remove refrigerant;
- Purify the pipeline with inert gas;
- Vacuum the refrigerant system;
- Purify the pipeline with inert gas again;
- Cut pipeline or weld it as required.

10) Refrigerant charging

As a supplement to regular procedures of refrigerant charging, the following requirements are required.

- Ensure that there is no mutual contamination between different refrigerants during refrigerant charging.

The pipeline to fill system with refrigerant should be as short as possible in order to reduce the residual amount of refrigerant in it;

- The refrigerant tank should be kept vertically upwards;
- Ensure that the refrigeration system has been well grounded before charging;
- Label the system after charging is finished (or not yet completed);
- Only fill to the amount of refrigerant on the rating label. Overfilling is prohibited.

Before refilling the system, a pressure test should be performed with OFN. After charging, a leakage test is required before test run of heat pump. And please have a leakage test again before leaving the service area.

11) Precautions of refrigerant charging

Please make sure charging of refrigerant is done with correct amount based on information on unit label.

12) Emergency treatment

Emergency plan should be well prepared at service site and daily preventive measures should be carried out. For example, fire is forbidden at site and it is prohibited to wear clothing or shoes which can generate static or sparks.

- Suggested disposal in case of serious leakage of flammable refrigerant:
 - a) Turn on the ventilation equipments and cut off power supply of other devices. Persons should evacuate from site immediately.
 - b) Notify and evacuate the neighbouring people and residents in order and stay away from the site for at least 20 meters. Call the police and set up a warning region forbidding people and vehicles from approaching.
 - c) On-site treatment should be carried out by professional firefighters with anti-static clothing. Cut off the leakage source.
 - d) Purge and eliminate flammable refrigerant and residual gas at leakage point and surrounding area with nitrogen, especially for low-lying areas. Detect and verify the elimination work with professional detector until concentration of flammable refrigerant become zero. Only after that, alarm can be cleared.

! WARNING

All routine and extraordinary maintenance operations, such as breaking into the refrigerating circuit and opening of sealed components, must be carried exclusively by qualified personnel exclusively using original spare parts. The manufacturer is not liable for damage resulting from failure to observe this instruction, which may compromise the safety of the installation.

13) Requirement about storage of R32 refrigerant

- The refrigerant storage tank should be placed separately in the environment with ambient temperature between 14°F-122°F and with good ventilation. Warning labels should be placed in this area or on the tanks.
- For service tools in contact with the refrigerant, they should be stored and used separately. And the service tools designed for different refrigerants can not be mixed in usage or storage.

Part 7 - Maintenance

14) Operation specification about equipment dismantling

- Before dismantling, check and ensure safety at service area and keep good ventilation (open doors and windows). Ignition sources are prohibited at the place where equipment is dismantled and the combustible materials should be isolated.
- Please clear the refrigerant in equipment before dismantling.[For split type of equipment]
- Try to move the refrigerant pipes along with indoor unit.If the refrigerant pipes are too long, cut it from a position outside the house for easier removal.When the pipes are going to be used again,connect them with additional extension pipes by soldering. [For split type of equipment]
- For transportation, loading and unloading of equipment, please be careful and collision and drop are not allowed. It is forbidden to store the unit in a confined space or a space with ignition sources.

7.2 Attention

- 1) The user mustn't change the structure or wiring inside the unit.
- 2) The service and maintenance should be performed by qualified and well-trained technician. When the unit fails to run, please cut off power supply immediately.
- 3) The smart control system can automatically analyze various protection problems during daily use, and display the failure code on the controller.The unit may recover by itself. Under normal operation, the piping inside the unit don't need any maintenance.
- 4) In normal ambient conditions, the user only needs to clean the surface of the outdoor heat exchanger per month or quarter of a year.
- 5) If the unit runs in a dirty or oily environment, please clean the outdoor heat exchanger by professionals, using specified detergent, to ensure the performance and efficiency of the unit.
- 6) Please pay attention to the ambient environment, to check if the unit is installed firmly, or whether the air inlet and outlet of the outdoor unit is blocked.
- 7) Unless the water pump is damaged, no special service or maintenance should be taken to the water system inside the unit. It's recommended to clean water filter regularly or change it when it's very dirty or blocked.
- 8) If the unit will not be used in winter for a long time, please drain all the water inside the system, to prevent the water pipes from damage due to freezing.

7.3 Cleaning of water filter

The water filter should be cleaned according to the manual of water filter, to ensure the water flow of the water system. It is recommended that it be cleaned once in the first month, and then, once half a year.

7.4 Cleaning of plate heat exchanger

Thanks to the normally very high degree of turbulence in the heat exchanger, there is a self-cleaning effect in the channels. However, in some applications the fouling tendency can be very high, e.g. when using extremely hard water at high temperatures. In such cases it is always possible to clean the exchanger by circulating a cleaning liquid (CIP-Cleaning In Place). Use a tank with weak acid, 5% phosphoric acid or, if the exchanger is frequently cleaned, 5% oxalic acid. Pump the cleaning liquid through the exchanger.

This work should be done by qualified person. For further information, please contact your supplier.

7.5 Condenser coil

The condenser coils do not require any special maintenance, except when they are clogged by paper or any other foreign objects. Cleaning is by washing with detergent and water at low pressure, and then rinsing with clean water:

- 1) The unit needs to be powered off.
- 2) Inner of the unit must be cleaned by qualified person.
- 3) Do not use gasoline, benzene, detergent etc. to clean the unit. And do not spray with insecticide. Otherwise the unit may be damaged. Only cleaner that is designed to work with air conditioning units is to be used. If you do not know if the cleaner is appropriate. DO NOT USE and verify with your supplier prior to using the cleaner.
- 4) Spray air conditioner cleanser into the coils. Let the cleaner sit for 5-8 minutes.
- 5) Then, rinse the coil with clean water.
- 6) An old hairbrush works well for brushing surface dirt and lint off the fins. Brush in the same direction as the slots between the fins so the bristles go between the fins.
- 7) After cleaning, use a soft and dry cloth to clean the unit.

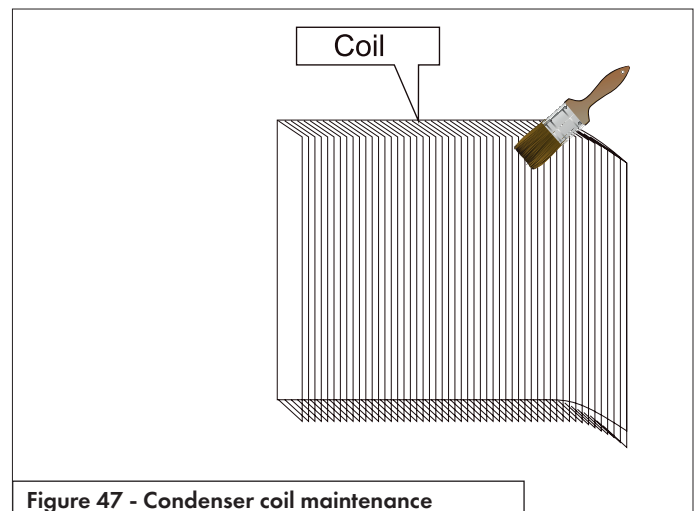

Figure 47 - Condenser coil maintenance

7.6 Gas charging

The refrigerant plays an important role in delivering energy in cooling or heating. Insufficient refrigerant affects directly efficiency of cooling and heating. Please pay attention to the following before adding refrigerant:

- 1) The work should be done by professionals.
- 2) If the system has not enough refrigerant inside, please check whether the system has leakage inside. If yes, please repair it before gas charging, otherwise unit will lack of refrigerant again after working for a short period.
- 3) Don't add too much refrigerant than required, or it may cause a lot of failures, such as high pressure and low efficiency.

- 4) This system uses R32 refrigerant. It is strictly forbidden to charge any refrigerant other than R32 into the system.
- 5) There must be no air in the refrigerant circulation, because air will cause abnormal high pressure, which will damage the gas piping and lower heating or cooling efficiency.
- 6) Refrigerant charge can only be done in cooling operation. Please proceed as followings:

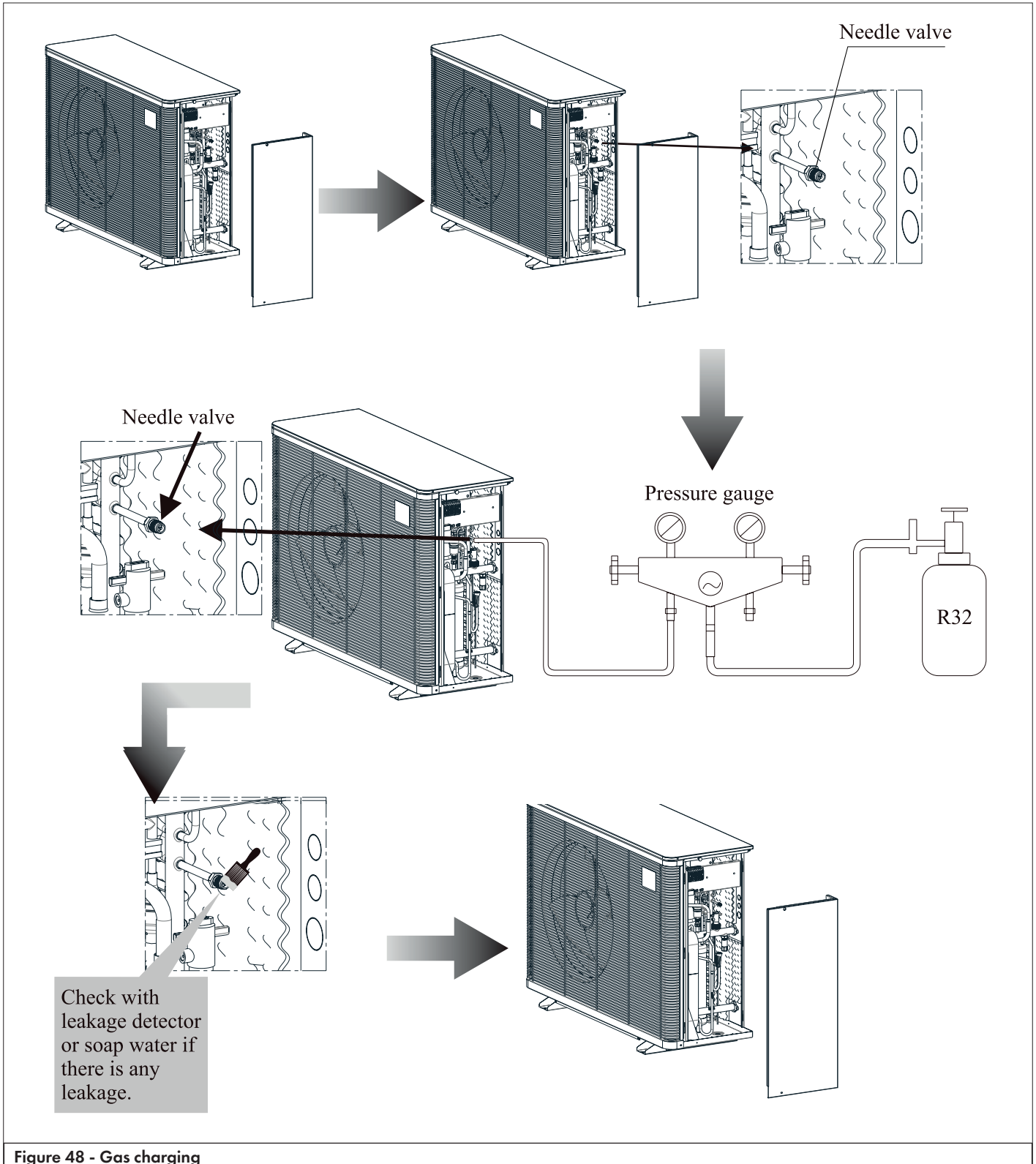
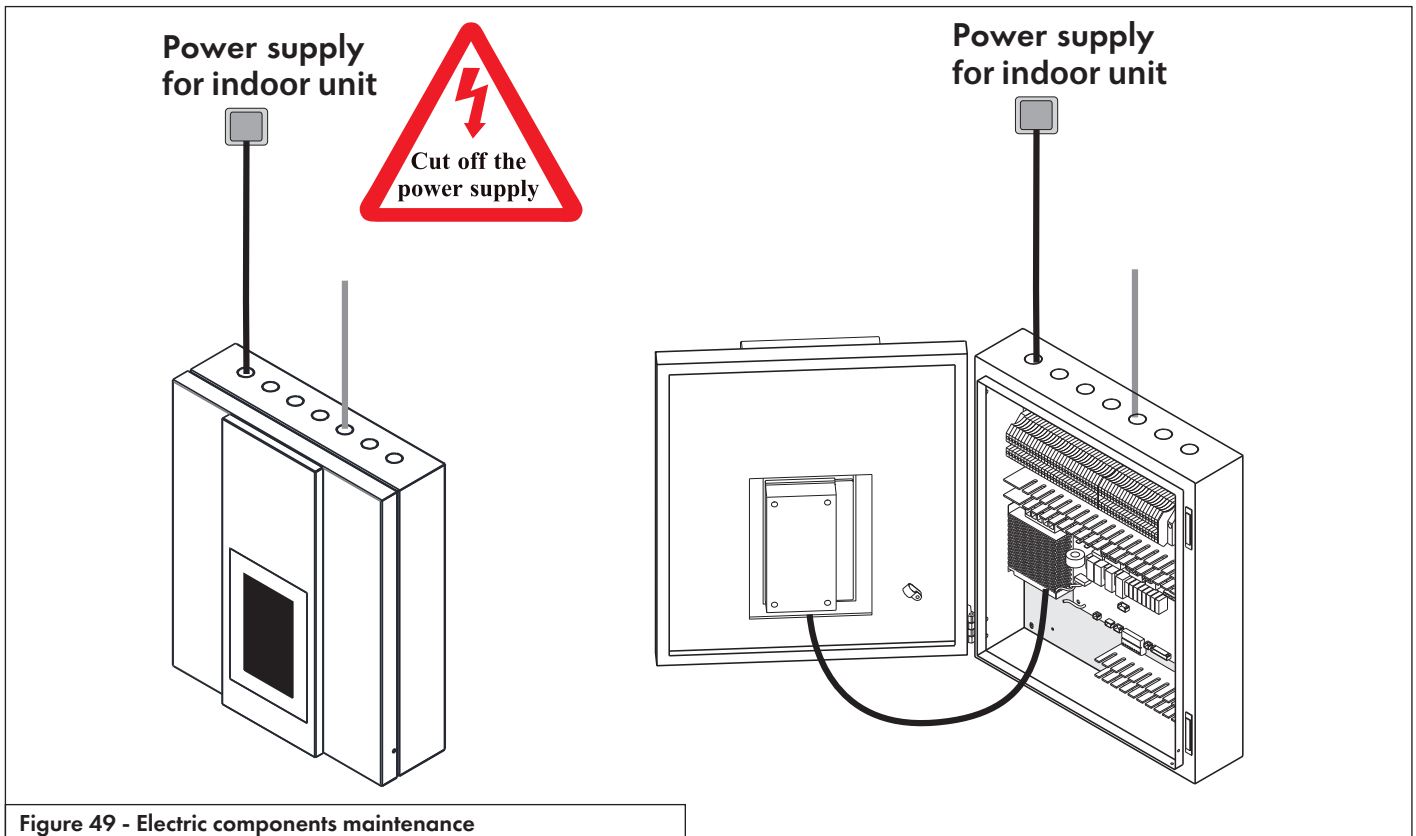

Figure 48 - Gas charging

7.7 Service of indoor control unit

7.7.1 Maintenance of the electric components

- 1) Cut off the power supply, open the indoor control unit front panel.
- 2) Do necessary service to electronics.



7.8 Service of monoblock outdoor unit

The service and maintenance should be performed by qualified and well-trained technician.

7.8.1 Maintenance of controller

- 1) Cut off the power supply, take off the top cover of the unit.
- 2) Take off the electric box cover.
- 3) Do necessary maintenance work to the controller of monoblock outdoor unit.

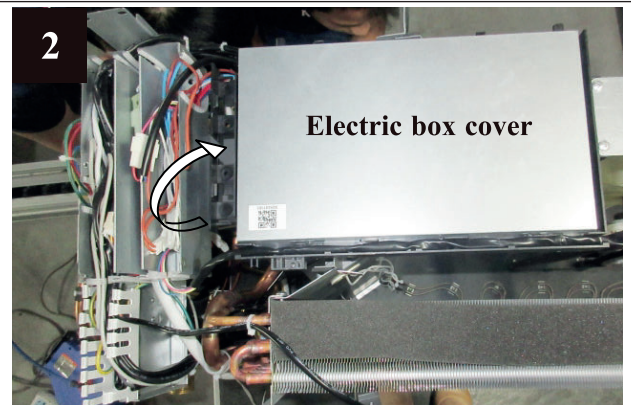

3 NHP32-036

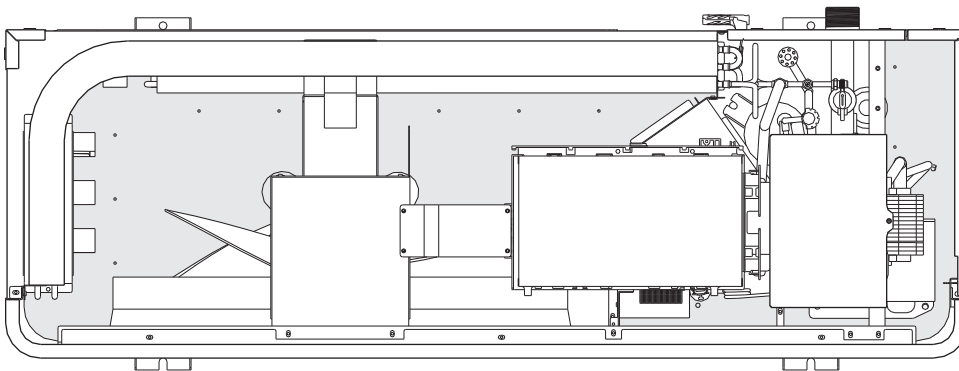

3 NHP32-060

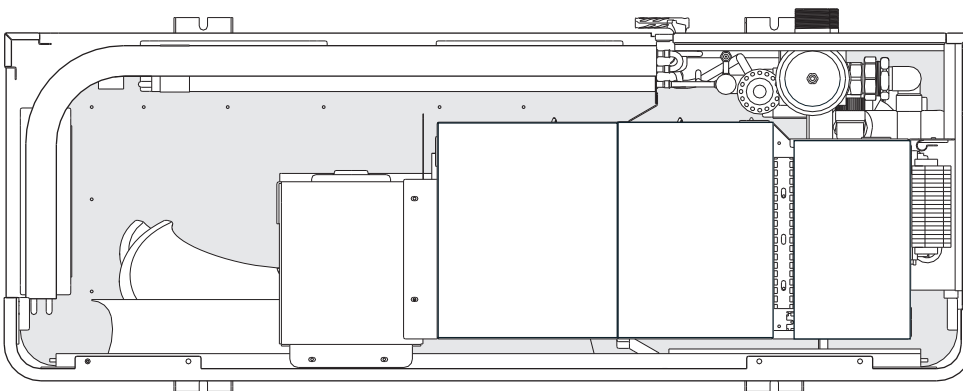

Figure 50 - Maintenance outdoor unit

Part 7 - Maintenance

7.8.2 Replacement of fan motor

- 1) Turn off power to the unit. Remove service panel and top cover
- 2) Remove front air grill and remove fan blade (s)

- 3) Remove power cable from the PCB
- 4) Replace the fan motor
- 5) Install new fan motor and re-route cable back to PCB.

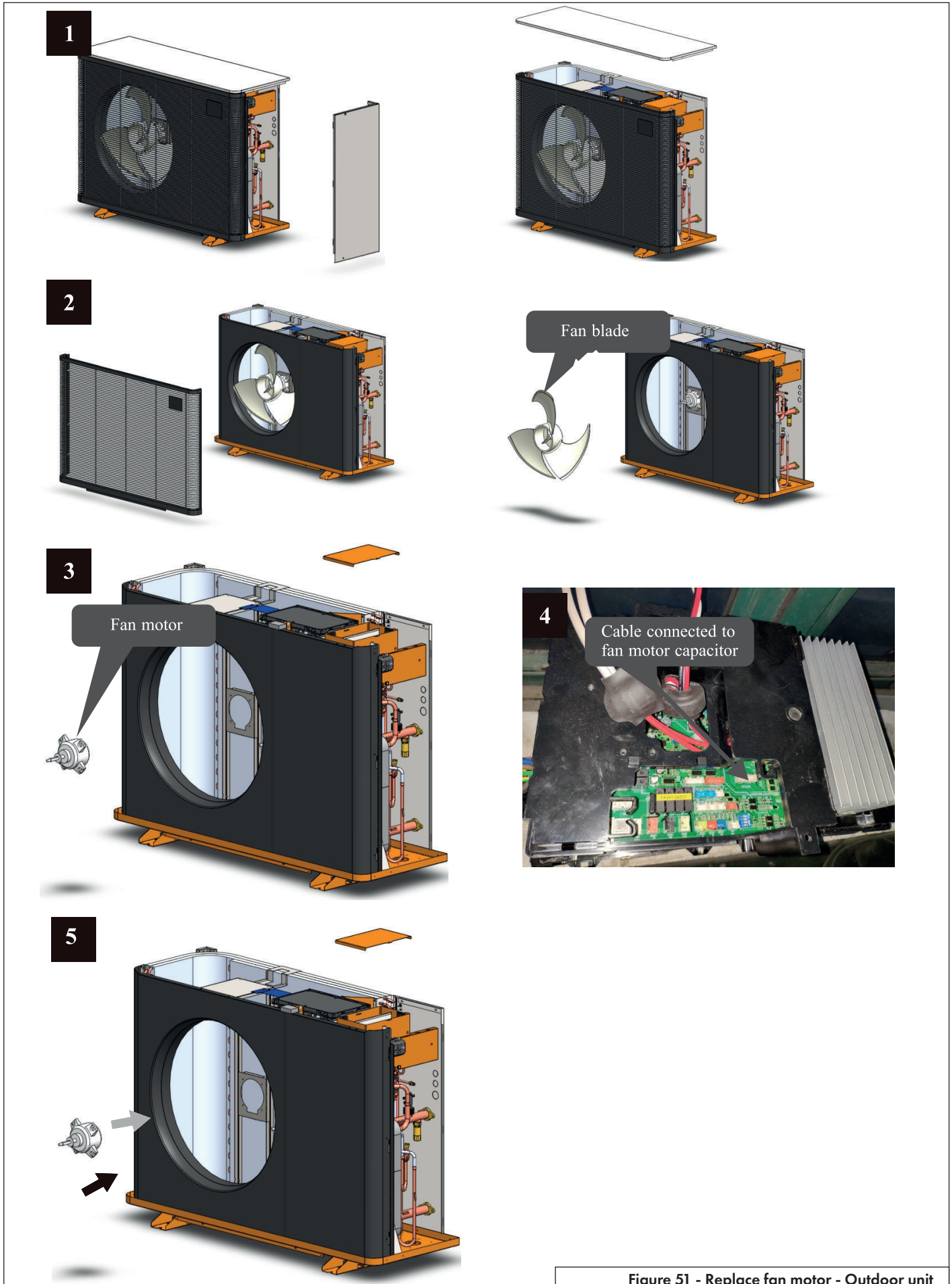
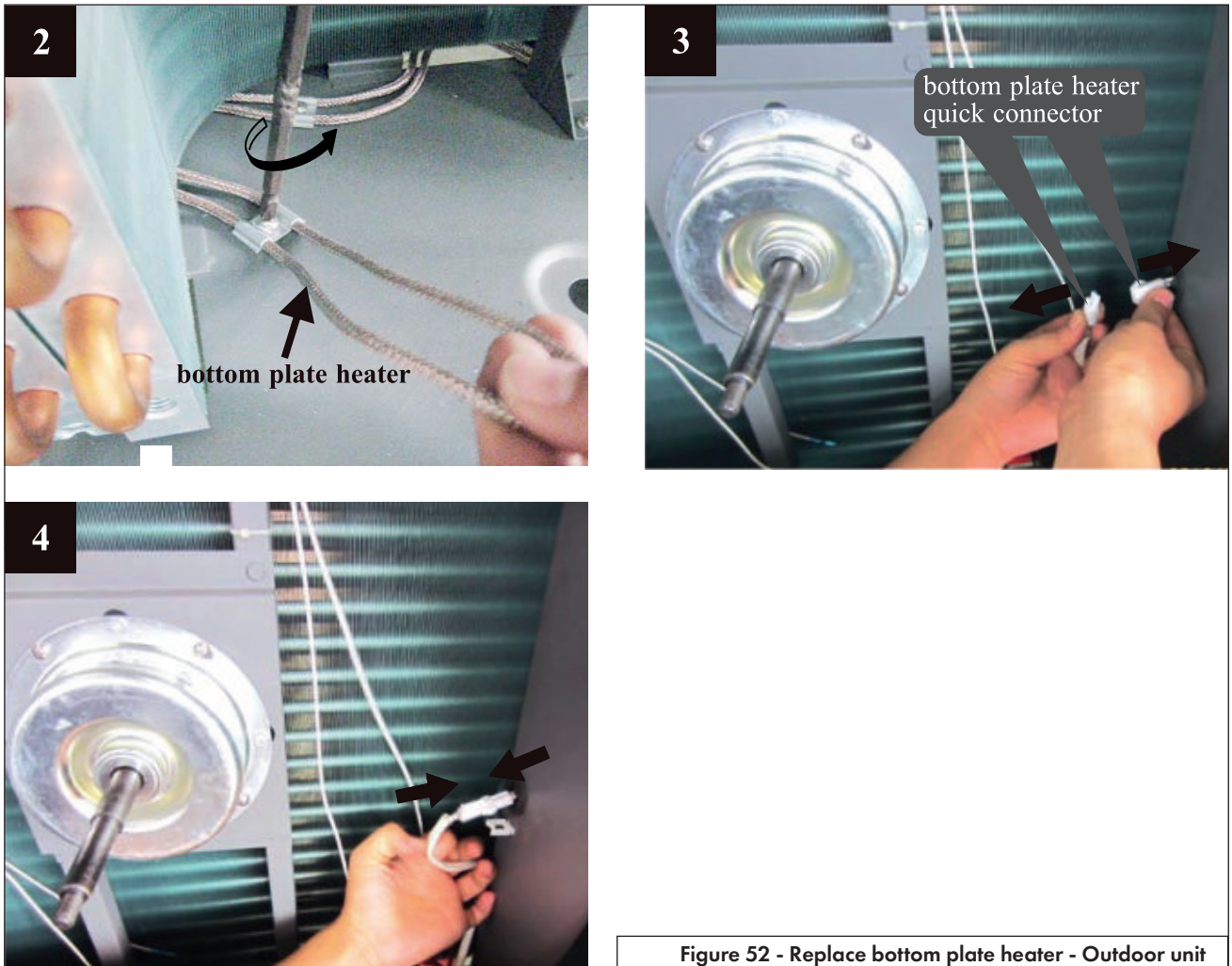

Figure 51 - Replace fan motor - Outdoor unit

7.8.3 Replacement of bottom plate heater

- 1) Cut off the power supply, follows 7.8.2 to take out the fan blade.
- 2) Take off the fixture of bottom plate heater(see picture 1).
- 3) Disconnect the quick connector for bottom plate heater and take the heater out (see picture 2).
- 4) Put a new bottom plate heater back, and connect it to the quick connector(see picture 3).



Part 8 - Exploded view

For Full Parts List consult the **SPARE PARTS - EXPLODED VIEW** Manual received with the product.

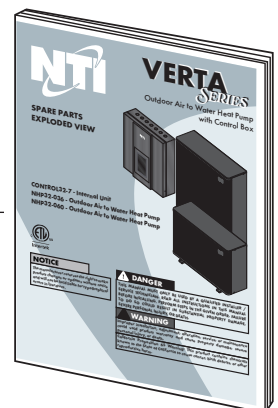

NTI Heat Pump Product Limited Warranty

Please retain proof of purchase, installation date and all service records.



A. What Does This Limited Warranty Cover?

This Limited Warranty covers all Parts in your NTI Boilers Inc (herein named "NTI") Air-To-Water Heat Pump Product against breakdown due to defects in materials and workmanship. NTI will replace or, at the sole discretion of NTI, repair any defective part. Any replaced part will be warranted for the longer of i) the unexpired portion of the original warranty period or ii) 90 days.

Labor and all other costs for the inspection or examination, removal and re-installation of defective parts, and transportation costs for defective or replacement parts, are **not** covered by this Warranty.

This warranty applies to all Heat Pump units produced on or after October 20, 2024.

B. How Long Does the Coverage Last?

Coverage	Coverage Duration *
Compressor	5 years from installation date
All Other Parts	3 years from installation date

* If the installation date cannot be determined, the Warranty Period will be considered to begin 60 days from the date the Product was shipped by NTI to a distributor, which NTI can determine using the Product serial number.

C. How Do You Make a Warranty Claim?

If you believe you have a claim under this Limited Warranty, please contact a local heating or plumbing contractor of your choice, that is familiar with the operation and service requirement of the products. Your contractor will perform a diagnosis to determine the cause of the issue and will work with NTI. to establish as to whether you may have a claim covered by this Warranty. If your contractor advises you that you may have a claim covered by this Warranty, then the contractor can choose to file the claim directly with NTI. on your behalf, or work through a local Wholesale Distribution Partner of NTI. You must make all parts that are subject to a warranty claim available to your contractor for return to NTI. If you have questions about this process or the status of your claim, you may contact the **NTI Technical Services** at **1-800-688-2575**, or email **info@ntiboilers.com**.

You can also find warranty details and procedures at **www.ntiboilers.com**.

D. What Is Not Covered Under This Warranty?

This Warranty is valid only for the original owner at the original location. Additionally, this Warranty does not cover claims if the failure, malfunction, or unsatisfactory performance of, or damage to, your Product resulted from or is attributable to:

- (1) Installation not completed in accordance with manufacturer's instructions;
- (2) Components or replacement Service Parts that are not furnished by NTI;
- (3) The failure to properly size the Product for its use;
- (4) Repairs or replacement of parts required as a result of poor workmanship of the Contractor;
- (5) Repairs or replacement of parts required due to inaccurate diagnosis and troubleshooting by a Contractor that did not include the assistance of the NTI Technical Services Department;
- (6) Failure to inspect and maintain the venting;
- (7) Water conditions outside of NTI's acceptable parameters, as stated in the NTI product manuals supplied with the product, including, but not limited to, water chemistry, levels of Total Dissolved Solids (TDS) and pH levels, chemical or electrochemical reaction, water impurities, unsuitable water conditions as per system design guidelines, water treatment chemicals;

- (8) Sediment, magnetite, or scale formation on the water side of the pressure vessel;
- (9) Installing the Product in an unsuitable location or continuing use after onset of a malfunction or discovery of a defect;
- (10) Information supplied by parties other than NTI without consultation and agreement by NTI;
- (11) Failure to inspect and service the Product in accordance with NTI's product manuals;
- (12) Freezing, accident, fire, flood, or force majeure, power surges or failures, abuse or misuse, unauthorized alteration;
- (13) Damages or Liability caused by negligent operation, unsuitable or improper use or operation of the Product, including, but not limited to, improper installation, incorrect or careless handling, improper start-up, lack of proper adjustment to control parameter default settings, improper control strategy, incorrect combustion adjustment, disregard of the operating and maintenance instructions or any other instructions supplied with the Product;
- (14) Damage to the Product or any of its parts caused by matters outside the control of NTI;
- (15) Normal wear and tear and/or consumption of parts including, but not limited to, fuses, capacitors, motors etc...
- (16) Any repair or purchase made by unauthorized person(s) or companies. Purchases and repairs of these products shall only be done through NTI authorized/approved companies.

If you have any questions about your coverage under this Limited Lifetime Warranty, please contact NTI at **info@ntiboilers.com** or the Contact Us form on our website, **www.ntiboilers.com**. Please review all printed material accompanying the Product to learn how to properly care for and maintain your Product. Additional information may also be found on our website, listed above.

NTI'S MAXIMUM LIABILITY SHALL NOT EXCEED THE ACTUAL PURCHASE PRICE PAID BY YOU FOR YOUR PRODUCT. IN NO EVENT SHALL NTI BE RESPONSIBLE FOR INDIRECT, INCIDENTAL, CONSEQUENTIAL (INCLUDING WITHOUT LIMITATION DAMAGE TO OR LOSS OF OTHER PROPERTY), OR PUNITIVE DAMAGES, WHETHER SUCH CLAIM OR ACTION IS BASED ON CONTRACT, WARRANTY, NEGLIGENCE, STRICT LIABILITY, OR ANY OTHER LEGAL THEORY.

Some states or provinces do not allow the exclusion or limitation of incidental or consequential damages, so the above limitation or exclusion may not apply to you.

ALL IMPLIED WARRANTIES ARE LIMITED IN THEIR DURATION TO THE APPLICABLE WARRANTY PERIOD STATED ABOVE. ALL IMPLIED WARRANTIES, INCLUDING MERCHANTABILITY AND FITNESS FOR A PARTICULAR PURPOSE, ARE DISCLAIMED IN THEIR ENTIRETY AFTER EXPIRATION OF THEIR APPLICABLE WARRANTY PERIOD SET FORTH ABOVE.

Some states or provinces do not allow limitations on how long an implied warranty lasts, so the above limitation may not apply to you.

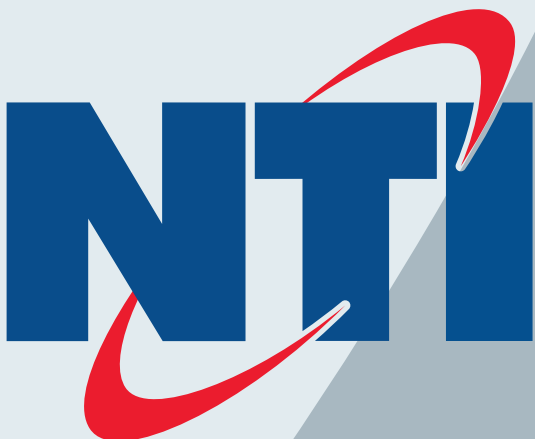

NTI Boilers Inc.

30 Stonegate Drive Saint John,
NB E2H 0A4 Canada

Technical Assistance: 1-800-688-2575

Website: www.ntiboilers.com

Fax: 1-506-432-1135



Visit us online