

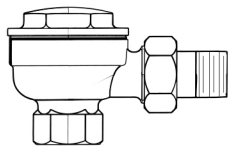

Hoffman Specialty® Series 8C, 9C and 17C Balanced Pressure Thermostatic Steam Traps

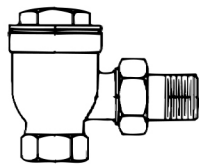

Model 8C Angle
½ NPT



Model 8C and 17C Angle
¾ NPT

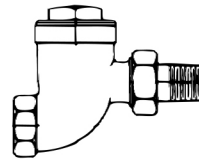

Model 8C and 17C
Straightaway
¾ NPT

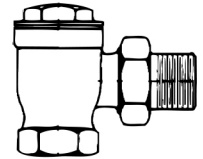

Model 9C and 17C
1 NPT

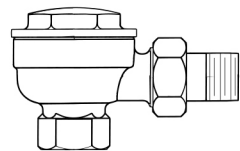

Model 17C Angle
w/short nipple
½ NPT

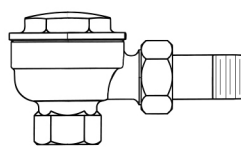

Model 17C
Angle
½ NPT

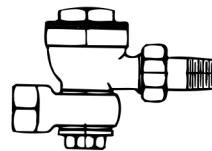

Model 17C
Swivel
½ NPT



Model 17C Vertical
½ NPT



⚠ CAUTION

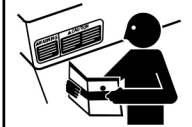

- Before using product, read and understand instructions.
- Save these instructions for future reference.



- All work must be performed by qualified personnel trained in the proper application, installation, and maintenance of steam systems in accordance with all applicable codes and ordinances.
- To prevent serious burns, wear heat resistant gloves when opening and closing steam valves, or handling hot equipment.
- To prevent serious burns, the internal pressure of the trap must be 0 psi (0 bar) before servicing.



- To prevent serious personal injury from steam pipe blow down, connect a temporary pipe between the steam pipe opening and a drain, or stand at least 100 ft. (30m) from the front of the pipe opening.

Failure to follow this caution will cause personal injury.

IMPORTANT: To prevent system damage from water hammer or sudden shock, open supply valves slowly.

The trap pressure rating must be equal or greater than the maximum system pressure.

If you are uncertain about the product's adaptability for your application, please call the factory or authorized representative before using the product.

INSTALLATION –

STEP 1 - Where to Install the Thermostatic Steam Trap

Determine where to install the thermostatic steam trap based on the following information.

- a. The trap should be located below the equipment to be drained.
- b. The trap discharge should drain by gravity into a vented return line.
- c. Allow plenty of space around the trap for servicing, which may require removal of the cap or body.

TYPICAL INSTALLATION DIAGRAMS

A. For Radiators

Radiator connections taken from up or downfeed risers

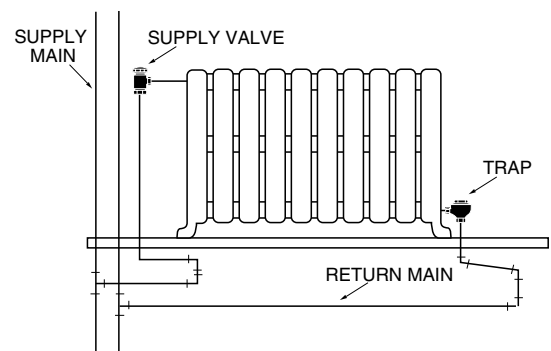
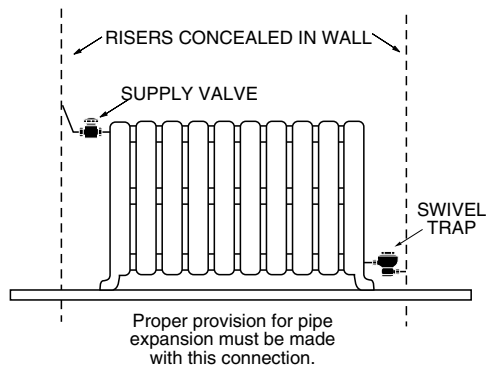

Dripping heel of downfeed riser into dry return

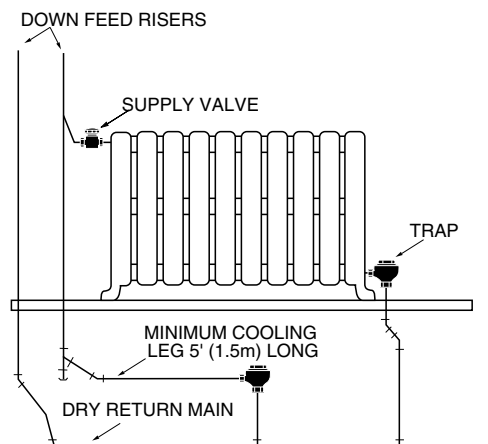

INSTALLATION –

STEP 1 - Where to Install the Thermostatic Steam Trap (cont'd)

TYPICAL INSTALLATION DIAGRAMS

A. For Radiators (cont'd)

Radiator connections from horizontal supply main into dry return

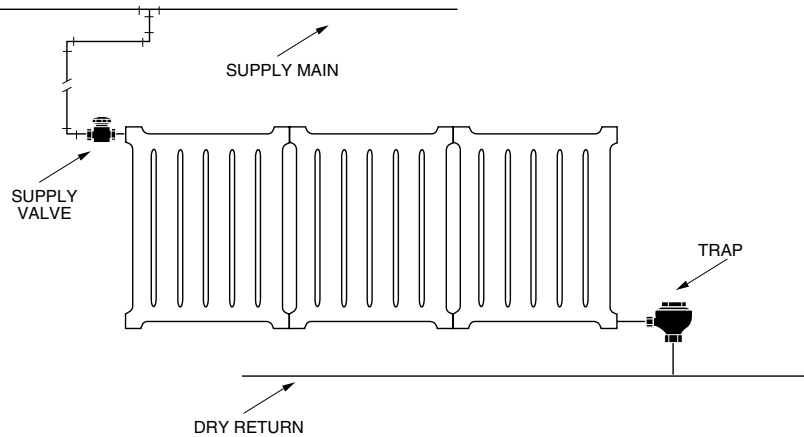

Connections to ceiling radiator located above supply and return

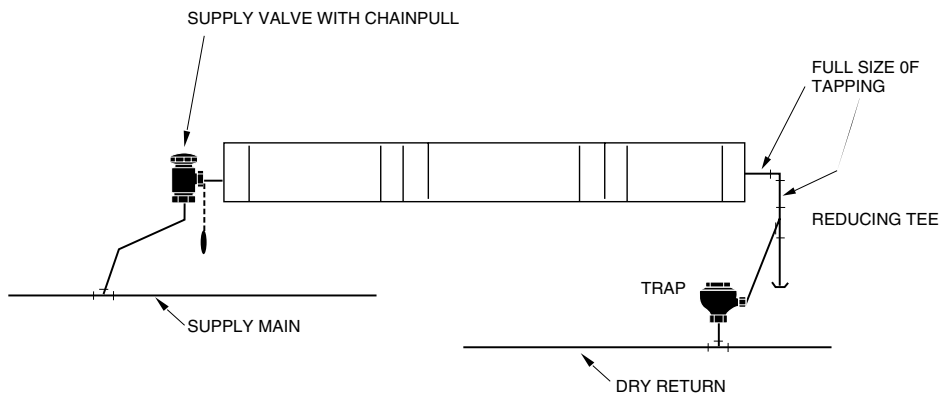

Connections to ceiling radiators with return bleed into wet return

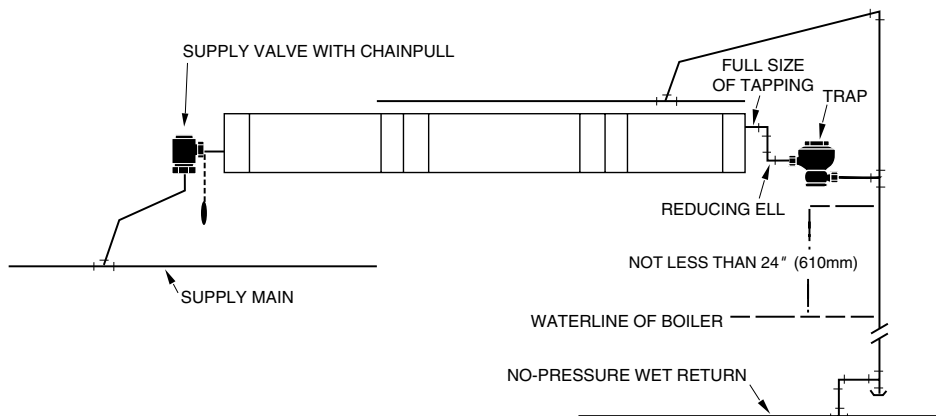

INSTALLATION –

STEP 1 - Where to Install the Thermostatic Steam Trap (cont'd)

TYPICAL INSTALLATION DIAGRAMS

B. For Steam Unit Heaters

Unit heater connections for two pipe gravity or vacuum system with supply branch dripped through trap

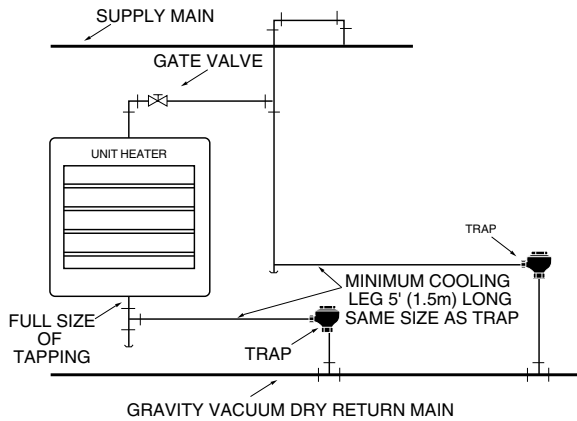

Unit heater connections for two pipe gravity or vacuum system

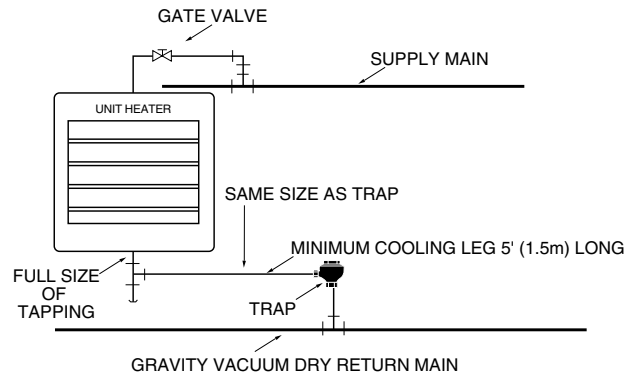

C. For Drip Traps

Dripping drop riser or end of main into dry return

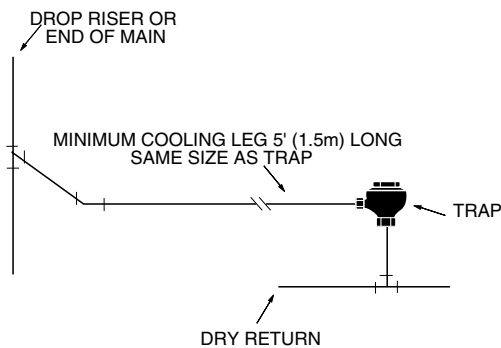

Dripping end of supply main into dry return

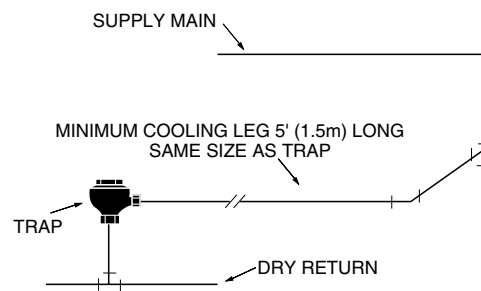

INSTALLATION –

STEP 1 - Where to Install the Thermostatic Steam Trap (cont'd)

TYPICAL INSTALLATION DIAGRAMS

D. For Convectors

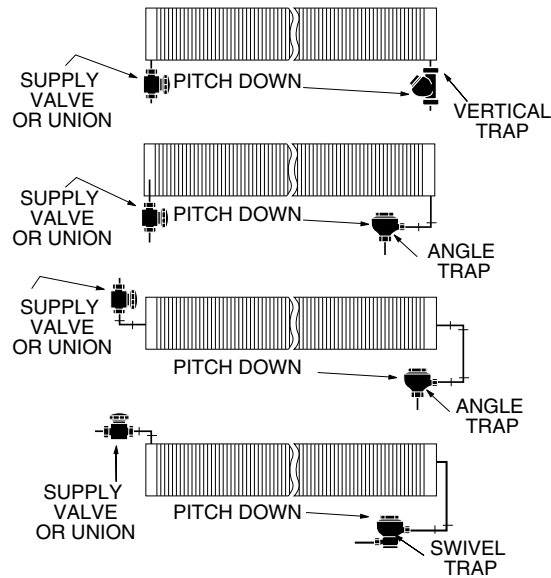

E. For Pipe Coils

Connections to header coils (not over 8 pipes)

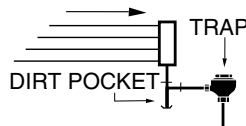

Connections to header coils (more than 8 pipes)

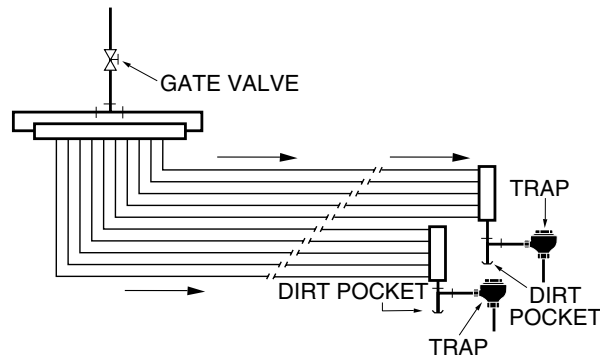

INSTALLATION –

STEP 2 - Install Trap

- a. Steam lines and equipment connected to the trap should be clean. If necessary, blow down the equipment with steam and allow it to cool before servicing, or flush with water.

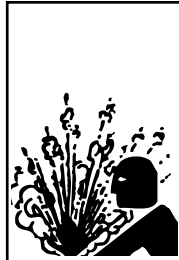

CAUTION

To prevent serious personal injury from steam pipe blow down, connect a temporary pipe between the steam pipe opening and a drain, or stand at least 100 ft. (30m) from the front of the pipe opening.

Failure to follow this caution will cause serious personal injury.

- b. Slide the union nut (A) over the nipple (B) so that the union nut threads (C) extend beyond the union end of the nipple (D).

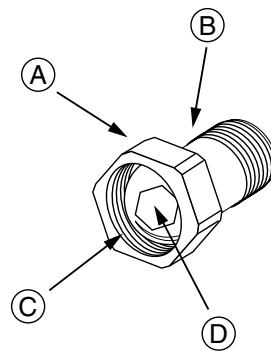

- c. Screw the nipple (B) into the equipment's condensate drain connection (E).

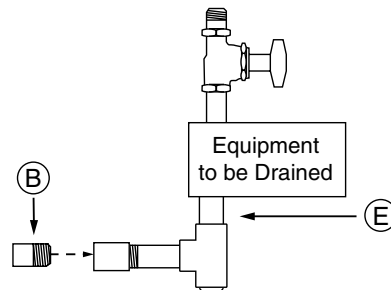

- d. Screw the nipple and union nut (F) on to the trap body (G).

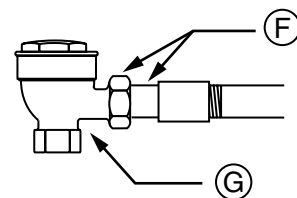

INSTALLATION –

STEP 2 - Install Trap (cont'd)

- e. Connect the trap discharge tapping (H) to the return line (J). It should be positioned so that the return line can drain by gravity.
- f. **Slowly** open the steam supply valve.

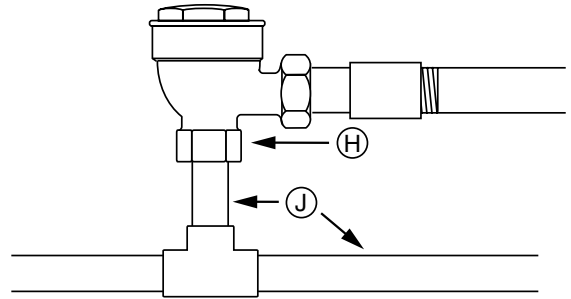

STEP 3 - Testing

- a. Inspect joints for leaks. Stop all leaks by tightening joints, if necessary

MAINTENANCE



When checked regularly and properly maintained, the Balanced Pressure Thermostatic Steam Traps will provide optimum performance and long life.

SCHEDULE:

- **Initially, every 2-3 days after start-up until system is clean.**
- **Every 6 months thereafter.**

PROCEDURE:

Test traps by following the “Troubleshooting” procedure.

	⚠ CAUTION
	<ul style="list-style-type: none">• To prevent serious burns, the internal pressure of the trap must be 0 psi (0 bar) before servicing.• To prevent serious personal injury from steam pipe blow down, connect a temporary pipe between the steam pipe opening and a drain, or stand at least 100 ft. (30m) from the front of the pipe opening. <p>Failure to follow this caution will cause personal injury.</p>

TROUBLESHOOTING

We recommend trap replacement when parts no longer operate properly. A new trap is more economical than repairing or replacing parts and it will provide greater reliability. If you choose to repair the trap, order Hoffman Specialty replacement parts and follow the Repair Procedure provided.

Problem:

1. Improper Heating

- a. **Cause:** The thermostatic element is not opening or functioning properly. This could be caused by dirt, or a broken element.

Test: Use a thermometer to test inlet temperature. A cold trap is an indication the trap failed closed.

Solution: Disassemble the trap and inspect the thermostatic assembly. Replace any worn or defective parts. Clean any dirt from trap body.

Problem:

2. Energy Wasted

- a. **Cause:** A leak in the thermostatic element caused a loss of fill in the element, which caused the element to fail open.

Test: Using a stethoscope or ultra sound device, listen for a low pitch whistle sound. A low pitch whistle sound indicates the trap is open and blowing live steam.

OR

Using a thermometer, check the trap inlet temperature. It should be at least 20°F (11°C) below the temperature in the steam space ahead of the trap.

Solution: Replace the trap or disassemble the trap and replace the thermostatic element.

COMMERCIAL WARRANTY

Warranty. For goods sold to commercial buyers, Seller warrants the goods sold to Buyer hereunder (with the exception of membranes, seals, gaskets, elastomer materials, coatings and other "wear parts" or consumables all of which are not warranted except as otherwise provided in the quotation or sales form) will be (i) be built in accordance with the specifications referred to in the quotation or sales form, if such specifications are expressly made a part of this Agreement, and (ii) free from defects in material and workmanship for a period of one (1) year from the date of installation or two (2) years from the date of manufacture, whichever shall occur first, unless a longer period is specified in the product documentation (the "Warranty").

Except as otherwise required by law, Seller shall, at its option and at no cost to Buyer, either repair or replace any product which fails to conform with the Warranty provided Buyer gives written notice to Seller of any defects in material or workmanship within ten (10) days of the date when any defects or non-conformance are first manifest. Under either repair or replacement option, Seller shall not be obligated to remove or pay for the removal of the defective product or install or pay for the installation of the replaced or repaired product and Buyer shall be responsible for all other costs, including, but not limited to, service costs, shipping fees and expenses. Seller shall have sole discretion as to the method or means of repair or replacement. Buyer's failure to comply with Seller's repair or replacement directions shall terminate Seller's obligations under this Warranty and render the Warranty void. Any parts repaired or replaced under the Warranty are warranted only for the balance of the warranty period on the parts that were repaired or replaced. Seller shall have no warranty obligations to Buyer with respect to any product or parts of a product that have been: (a) repaired by third parties other than Seller or without Seller's written approval; (b) subject to misuse, misapplication, neglect, alteration, accident, or physical damage; (c) used in a manner contrary to Seller's instructions for installation, operation and maintenance; (d) damaged from ordinary wear and tear, corrosion, or chemical attack; (e) damaged due to abnormal conditions, vibration, failure to properly prime, or operation without flow; (f) damaged due to a defective power supply or improper electrical protection; or (g) damaged resulting from the use of accessory equipment not sold or approved by Seller. In any case of products not manufactured by Seller, there is no warranty from Seller; however, Seller will extend to Buyer any warranty received from Seller's supplier of such products.

THE FOREGOING WARRANTY IS EXCLUSIVE AND IN LIEU OF ANY AND ALL OTHER EXPRESS OR IMPLIED WARRANTIES, GUARANTEES, CONDITIONS OR TERMS OF WHATEVER NATURE RELATING TO THE GOODS PROVIDED HEREUNDER, INCLUDING WITHOUT LIMITATION ANY IMPLIED WARRANTIES OF MERCHANTABILITY AND FITNESS FOR A PARTICULAR PURPOSE, WHICH ARE HEREBY EXPRESSLY DISCLAIMED AND EXCLUDED. EXCEPT AS OTHERWISE REQUIRED BY LAW, BUYER'S EXCLUSIVE REMEDY AND SELLER'S AGGREGATE LIABILITY FOR BREACH OF ANY OF THE FOREGOING WARRANTIES ARE LIMITED TO REPAIRING OR REPLACING THE PRODUCT AND SHALL IN ALL CASES BE LIMITED TO THE AMOUNT PAID BY THE BUYER FOR THE DEFECTIVE PRODUCT. IN NO EVENT SHALL SELLER BE LIABLE FOR ANY OTHER FORM OF DAMAGES, WHETHER DIRECT, INDIRECT, LIQUIDATED, INCIDENTAL, CONSEQUENTIAL, PUNITIVE, EXEMPLARY OR SPECIAL DAMAGES, INCLUDING BUT NOT LIMITED TO LOSS OF PROFIT, LOSS OF ANTICIPATED SAVINGS OR REVENUE, LOSS OF INCOME, LOSS OF BUSINESS, LOSS OF PRODUCTION, LOSS OF OPPORTUNITY OR LOSS OF REPUTATION.

LIMITED CONSUMER WARRANTY

Warranty. For goods sold for personal, family or household purposes, Seller warrants the goods purchased hereunder (with the exception of membranes, seals, gaskets, elastomer materials, coatings and other "wear parts" or consumables all of which are not warranted except as otherwise provided in the quotation or sales form) will be free from defects in material and workmanship for a period of one (1) year from the date of installation or two (2) years from the product date code, whichever shall occur first, unless a longer period is provided by law or is specified in the product documentation (the "Warranty").

Except as otherwise required by law, Seller shall, at its option and at no cost to Buyer, either repair or replace any product which fails to conform with the Warranty provided Buyer gives written notice to Seller of any defects in material or workmanship within ten (10) days of the date when any defects or non-conformance are first manifest. Under either repair or replacement option, Seller shall not be obligated to remove or pay for the removal of the defective product or install or pay for the installation of the replaced or repaired product and Buyer shall be responsible for all other costs, including, but not limited to, service costs, shipping fees and expenses. Seller shall have sole discretion as to the method or means of repair or replacement. Buyer's failure to comply with Seller's repair or replacement directions shall terminate Seller's obligations under this Warranty and render this Warranty void. Any parts repaired or replaced under the Warranty are warranted only for the balance of the warranty period on the parts that were repaired or replaced. The Warranty is conditioned on Buyer giving written notice to Seller of any defects in material or workmanship of warranted goods within ten (10) days of the date when any defects are first manifest.

Seller shall have no warranty obligations to Buyer with respect to any product or parts of a product that have been: (a) repaired by third parties other than Seller or without Seller's written approval; (b) subject to misuse, misapplication, neglect, alteration, accident, or physical damage; (c) used in a manner contrary to Seller's instructions for installation, operation and maintenance; (d) damaged from ordinary wear and tear, corrosion, or chemical attack; (e) damaged due to abnormal conditions, vibration, failure to properly prime, or operation without flow; (f) damaged due to a defective power supply or improper electrical protection; or (g) damaged resulting from the use of accessory equipment not sold or approved by Seller. In any case of products not manufactured by Seller, there is no warranty from Seller; however, Seller will extend to Buyer any warranty received from Seller's supplier of such products.

THE FOREGOING WARRANTY IS PROVIDED IN PLACE OF ALL OTHER EXPRESS WARRANTIES. ALL IMPLIED WARRANTIES, INCLUDING BUT NOT LIMITED TO THE IMPLIED WARRANTIES OF MERCHANTABILITY AND FITNESS FOR A PARTICULAR PURPOSE, ARE LIMITED TO ONE (1) YEAR FROM THE DATE OF INSTALLATION OR TWO (2) YEARS FROM THE PRODUCT DATE CODE, WHICHEVER SHALL OCCUR FIRST. EXCEPT AS OTHERWISE REQUIRED BY LAW, BUYER'S EXCLUSIVE REMEDY AND SELLER'S AGGREGATE LIABILITY FOR BREACH OF ANY OF THE FOREGOING WARRANTIES ARE LIMITED TO REPAIRING OR REPLACING THE PRODUCT AND SHALL IN ALL CASES BE LIMITED TO THE AMOUNT PAID BY THE BUYER FOR THE DEFECTIVE PRODUCT. IN NO EVENT SHALL SELLER BE LIABLE FOR ANY OTHER FORM OF DAMAGES, WHETHER DIRECT, INDIRECT, LIQUIDATED, INCIDENTAL, CONSEQUENTIAL, PUNITIVE, EXEMPLARY OR SPECIAL DAMAGES, INCLUDING BUT NOT LIMITED TO LOSS OF PROFIT, LOSS OF ANTICIPATED SAVINGS OR REVENUE, LOSS OF INCOME, LOSS OF BUSINESS, LOSS OF PRODUCTION, LOSS OF OPPORTUNITY OR LOSS OF REPUTATION.

Some states do not allow limitations on how long an implied warranty lasts, so the above limitation may not apply to you. Some states do not allow the exclusion or limitation of incidental or consequential damages, so the above exclusions may not apply to you. This warranty gives you specific legal rights, and you may also have other rights which may vary from state to state.

To make a warranty claim, check first with the dealer from whom you purchased the product or call +1-847-966-3700 for the name and location of the nearest dealer providing warranty service.

xylem
Let's Solve Water

Xylem Inc.
8200 N. Austin Avenue
Morton Grove, Illinois 60053
Phone: (847) 966-3700
Fax: (847) 965-8379
www.bellgossett.com



Bell & Gossett is a trademark of Xylem Inc. or one of its subsidiaries.
© 2016 Xylem Inc. HS-229G January 2016 Part No. 510977