

# PolyPro<sup>®</sup>



**Polypropylene venting products  
for high-efficiency condensing  
appliance installations.  
Listed to ULC-S636.**

**DuraVent<sup>™</sup>**

*Leaders in-Venting Innovation<sup>™</sup>*

# PolyPro®

## Specifications

### Applications

PolyPro is a polypropylene vent pipe for use with ANSI Category II and IV gas-burning appliances, including high-efficiency water heaters, condensing boilers and warm air furnaces. PolyPro is listed by Intertek to the ULC S636 standard in Canada as a Class IIA, IIB and IIC vent system suitable for exhaust temperatures up to 230°F / 110°C, and a maximum positive pressure of 15 in-w.c.

### Materials and Construction

Rigid pipe constructed of 2.2mm (minimum) thick polypropylene. Flex is double-wall polypropylene. EPDM or optional Viton Gaskets

### Clearances

0" clearance to combustibles for exhaust temperatures up to 194°F / 90°C, and 0" clearance for vertical installations up to exhaust temperatures of 230°F / 110°C and ¼" / 6mm clearance to combustibles for horizontal installations at exhaust temperatures up to 230°F / 110°C. PolyPro concentric vent system components, including concentric Horizontal Termination and Vertical Termination, are listed at 0" clearance to combustibles for exhaust temperatures up to 230°F / 110°C. Double Wall PolyPro provides 0" clearance to combustibles.

### Diameters

2" (60mm), 3" (80mm), 4" (100mm), 5" (130mm), 6" (150mm), and 8" (200mm).  
2" x 4" (60mm x 100mm)  
3" x 5" (80mm x 130mm)  
4" x 6" (100mm x 150mm)

### Listings

Listed with the appliance in the USA and Canada, check with appliance manufacturer. Intertek / ETL listed to ULC S636 Listed as a Class IIA, IIB, and IIC vent system.

PolyPro is approved by the Massachusetts Plumbers Board. Approval code G1-0811-42.



PolyPro and PVC/CPVC: PVC pipes are commonly used for venting water heaters, condensing boilers and warm air furnaces. PolyPro is an engineered alternative for condensing gas appliances. Engineered for venting, it is easier and faster to install than PVC, saving the contractor time and money. Polypropylene has a higher operating temperature limit of 230°F/110°C (PVC is 149°F/65°C max and CPVC is 194°F/90°C). PolyPro is engineered with a condensation management system.

### Flex

PolyPro Flex through B Vent as a Chase: Retrofit venting for new, high-efficiency appliances. When replacing a mid-efficiency appliance with a new condensing 90+ appliance, you can use the existing B vent (any brand) as a chase for the new appliance with PolyPro. The perfect solution for utilizing the B Vent already in place, use the convenient pull cone to insert double-wall PolyPro Flex through the B Vent pipe and terminate in either a two pipe or single pipe system. At the other end is the unique B Vent/PolyPro Support Cap, allowing for the connection of flex to rigid PolyPro lengths and elbows to finish the installation.

### Terminations

DuraVent's concentric PolyPro vertical terminations are lab tested to handle harsh weather and remain icicle free in freezing temperatures. Air circulation and weather conditions like rain, wind and ice have the potential to reduce the efficiency of a unit's performance and the operation of its venting system.

### Double Wall

DW shells are offered separately, handling pipe lengths, elbows, and appliance connections. For installation, single wall PolyPro is inserted into the metal shell, which has a support disk inside. Adjustable DW sections are available if needed. The vent system is supported using typical means, including wall straps, elbow straps and roof or firestop supports. Vertical and Horizontal Terminations are available. Additionally, you can use adapters to transition from a DuraVent / Security Chimney stainless vent systems, to DW PolyPro. This integration of vent systems gives you unmatched installation flexibility.

### Concentric

PolyPro® Concentric provides users the most versatile polypropylene venting system for high efficiency, condensing appliances. The injection-molded modular system is designed with a powder-coated aluminum outer pipe and a polypropylene inner pipe. It does not require a locking band and provides users with a fast, safe, clean, and sustainable venting solution. The PolyPro Concentric system also includes elbows that have a smooth wall lining and are designed to reduce condensate that may be left behind.

The DuraVent PolyPro product line is superior in performance and easier to install than PVC or CPVC pipe. Polypropylene has a higher operating temperature limit of 230°F/110°C (PVC is 149°F/65°C max and CPVC is 194°F/90°C), and PolyPro is engineered with a corrosion-free, condensation management system.

## Commercial & OEM Product Development

DuraVent engineers are expertly skilled to develop venting components to OEM specs. To satisfy specific venting requirements, DuraVent has the experience to provide custom design, prototyping and testing of vent systems and components engineered to the demands of specific appliances.

## The PolyPro Commercial Difference

- Available in 5in. (130mm), 6in. (150mm) and 8in. (200mm) diameters.
- Completely smooth inner wall for optimal flow performance.
- Components designed for complete discharge of condensate.
- Design allows for system distance adjustment from the back of the appliance.
- Sizing services available to help in calculating required vent size.

## PolyPro® Locking Clamp

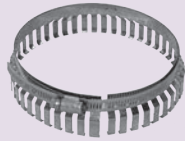

DuraVent is dedicated to one thing: focusing on the design and manufacturing of venting products. As experts in this industry, our team is passionate about creating innovative, quality products. We invest in equipment with the latest technology to develop and test venting products that are engineered to one standard: excellence. All measuring equipment is calibrated to the same levels as used by testing agencies and are compliant with ISO 17025, the test-laboratory standard.



## Wind Tunnel Laboratory

The wind tunnel lab allows us to gather precise data with 270 degrees of measurement on terminations. All data is analyzed for product performance under rigorous conditions before going to market.

## Rain Testing

Labs test the vapor/moisture barrier of products by subjecting them to extreme rain and wind conditions. These tests are compliant with both the US and Canadian requirements as well as the stringent European standards.

## Climate Testing

Labs have developed a patented ice testing system in the climate room. Tests run to -4°F (-20°C). PolyPro vertical terminations are engineered to remain icicle free.

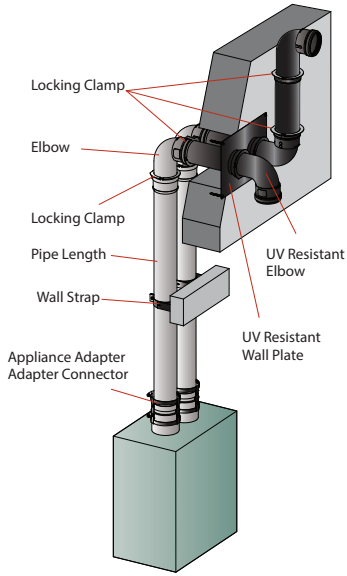

**Horizontal Twin Pipe Elbow Termination**

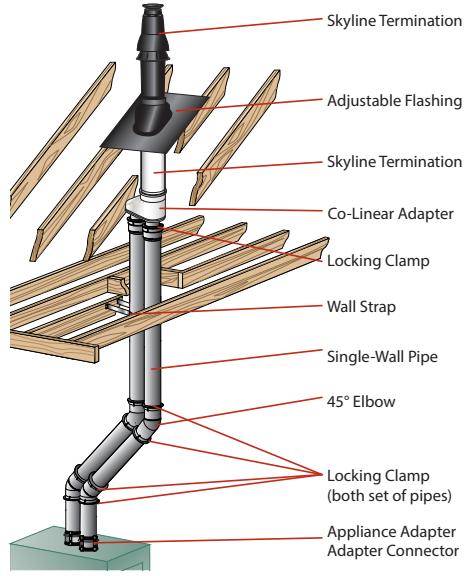

**Twin Pipe with Concentric Termination**

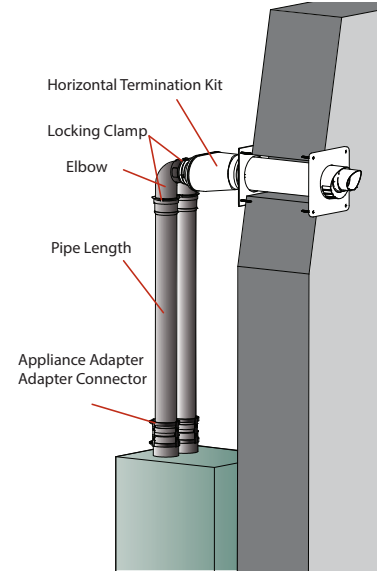

**Horizontal Twin Pipe Concentric**

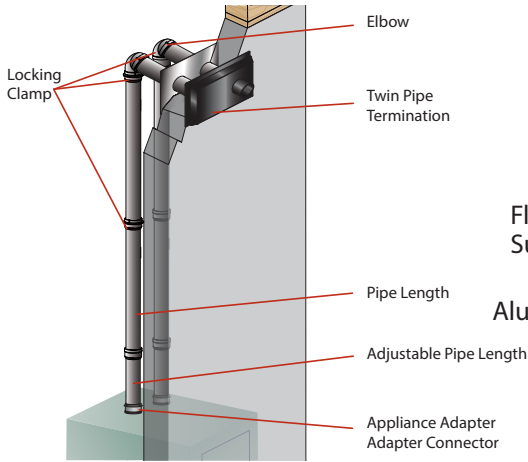

**Horizontal Twin Pipe Below Grade**

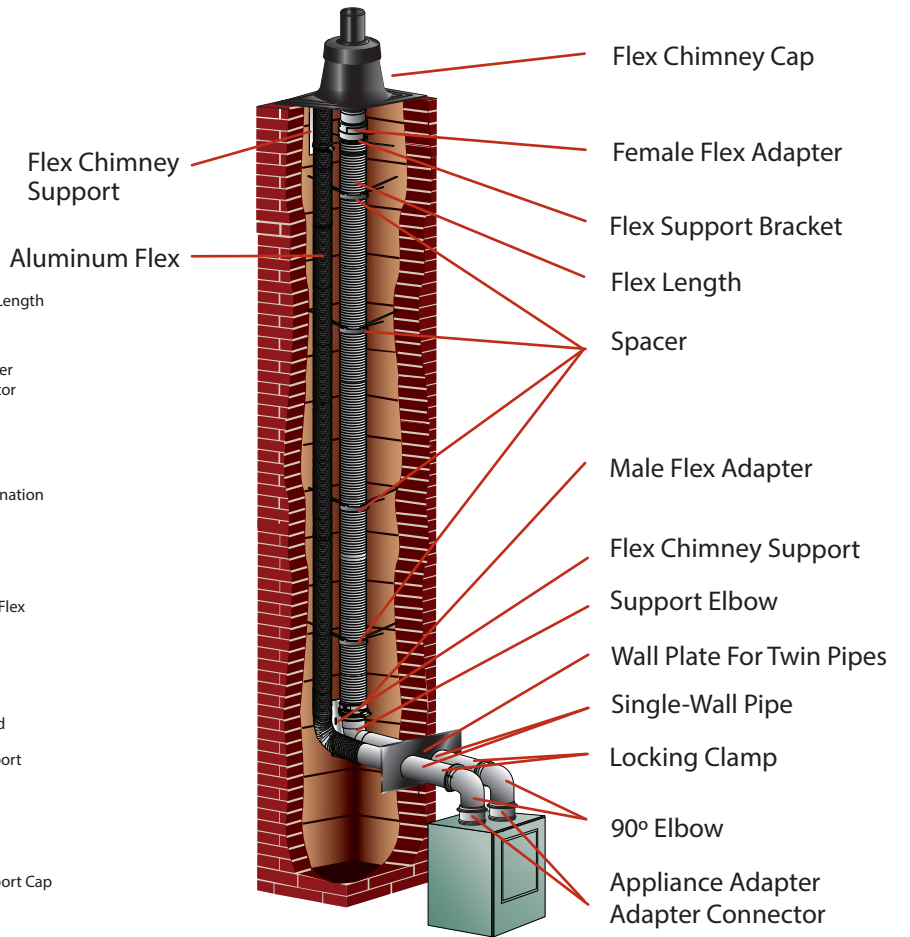

**Flex Through B vent as a Chase**

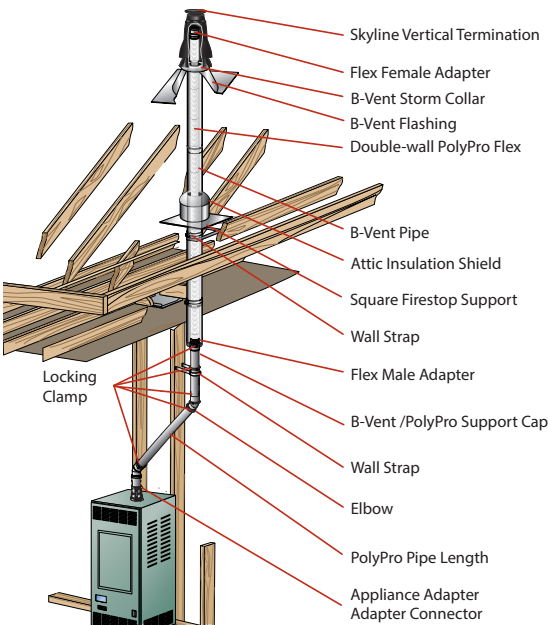

### Single-Wall Pipe

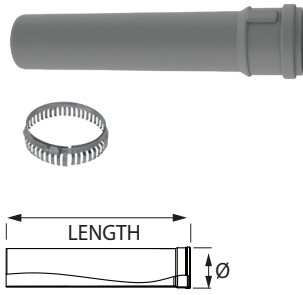

Use to vent condensing appliances. 2" (60mm) of overlap at the joint. Listed to ULC S636. Locking Clamps are required at all joint connections. Includes 1 Locking Clamp per each length .

SIZE	12"   305mm		36"   914mm		72"   1829mm	
	ORDER #	STOCK #	ORDER #	STOCK #	ORDER #	STOCK #
2"   60mm	2PPS-12C	810014475	2PPS-36C	810014477	2PPS-72C	810014479
3"   80mm	3PPS-12C	810014528	3PPS-36C	810014532	3PPS-72C	810014534
4"   100mm	4PPS-12C	810014587	4PPS-36C	810014589	4PPS-72C	810014591
5"   130mm	5PPS-12C	810014652	5PPS-36C	810014653	5PPS-72C	810014654
6"   150mm	6PPS-12C	810014681	6PPS-36C	810014683	6PPS-72C	810014685
SIZE	40"   1016mm		75"   1905mm			
	ORDER #	STOCK #	ORDER #	STOCK #		
8"   200mm	8PPS-40C	810014802	8PPS-75C	810014803		

### 9' Single-Wall Pipe

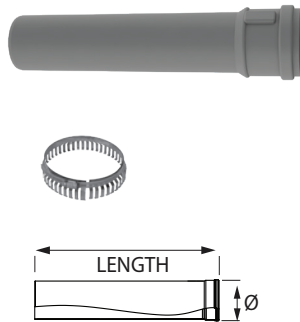

Use to vent condensing appliances. 2" (60mm) of overlap at the joint. Listed to ULC S636. Locking Clamps are required at all joint connections. Includes 1 Locking Clamp per each length. Sold in full box quantities only.

SIZE	9'   229mm	
	ORDER #	STOCK #
2"   60mm	2PPS-108	810014028
3"   80mm	3PPS-108	810013496
4"   100mm	4PPS-108	810013578
6"   150mm	6PPS-108	810013579

### Black UV Resistant Single-Wall Pipe

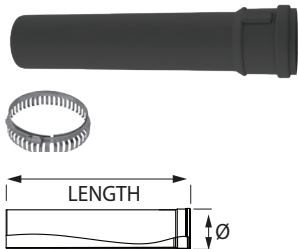

Use to vent condensing appliances. 2" (60mm) of overlap at the joint. Listed to ULC S636. Made of UV resistant polypropylene. Includes 1 Locking Clamp.

SIZE	12"   305mm		36"   914mm	
	ORDER #	STOCK #	ORDER #	STOCK #
2"   60mm	2PPS-12BC	810014476	2PPS-36BC	810014478
3"   80mm	3PPS-12BC	810014531	3PPS-36BC	810014533
4"   100mm	4PPS-12BC	810014588	4PPS-36BC	810014590
6"   150mm	6PPS-12BC	810014682	6PPS-36BC	810014684

### Adjustable Pipe

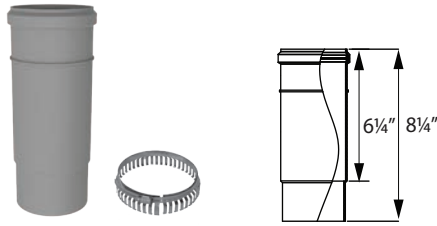

Use to add length to straight length of PolyPro pipe. Slips over any standard single-wall pipe length to form a telescoping pipe section. 4 1/2" (114mm) of adjustment. Adjustable pipe not available in 8" (200mm) diameter. Includes 1 Locking Clamp.

SIZE	ORDER #	STOCK #	SIZE	ORDER #	STOCK #
2"   60mm	2PPS-08ALC	810014853	5"   130mm	5PPS-08ALC	810014856
3"   80mm	3PPS-08ALC	810014854	6"   150mm	6PPS-08ALC	810014857
4"   100mm	4PPS-08ALC	810014855			

### Test Port



Use for combustion analysis testing without drilling holes into the vent system. Port cap is threaded for easy removal. Install immediately above the appliance. Includes 1 Locking Clamp.

SIZE	ORDER #	STOCK #	SIZE	ORDER #	STOCK #
2"   60mm	2PPS-TPC	810014496	5"   130mm	5PPS-TPC	810014663
3"   80mm	3PPS-TPC	810014551	6"   150mm	6PPS-TPC	810014695
4"   100mm	4PPS-TPC	810014610	8"   200mm	8PPS-TPC	810014812

### 45° Elbow

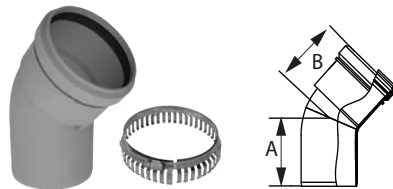

Offsets around obstructions as needed. Includes 1 Locking Clamp.

SIZE	ORDER #	STOCK #	A	B
2"   60mm	2PPS-E45C	810014481	2 7/8"   72.5mm	2 11/16"   69mm
3"   80mm	3PPS-E45C	810014537	2 7/8"   73mm	2 7/8"   73mm
4"   100mm	4PPS-E45C	810014594	2 13/16"   78mm	2 13/16"   78mm
5"   130mm	5PPS-E45C	810014656	3 3/4"   95mm	3 13/16"   98mm
6"   150mm	6PPS-E45C	810014689	3 13/16"   98mm	3 15/16"   101mm
8"   200mm	8PPS-E45C	810014807	4 7/16"   111mm	5 7/16"   131mm

### Black UV Resistant 45° Elbow



Offsets around obstructions as needed. Made of UV resistant polypropylene. May be used for terminations. Order Bird Guard Screen to protect opening when used as termination. Includes 1 Locking Clamp.

SIZE	ORDER #	STOCK #	A	B
2"   60mm	2PPS-E45BC	810014482	2 7/8"   73mm	2 11/16"   69mm
3"   80mm	3PPS-E45BC	810014538	2 7/8"   73mm	2 7/8"   73mm
4"   100mm	4PPS-E45BC	810014595	2 13/16"   78mm	2 1/2"   65mm

### 90° Elbow

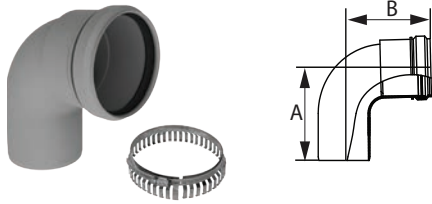

Offsets around obstructions as needed. Includes 1 Locking Clamp.

SIZE	ORDER #	STOCK #	A	B
2"   60mm	2PPS-E90C	810014483	4"   100mm	4"   100mm
3"   80mm	3PPS-E90C	810014529	4 5/16"   110mm	4 5/16"   110mm
4"   100mm	4PPS-E90C	810014596	4 1/2"   115mm	4 1/2"   115mm
5"   130mm	5PPS-E90C	810014657	6 3/4"   169mm	5 15/16"   152mm
6"   150mm	6PPS-E90C	810014690	7 1/4"   183mm	6 1/2"   166mm
8"   200mm	8PPS-E90C	810014808	8 15/16"   227mm	7 3/4"   195mm

### Black UV Resistant 90° Elbow

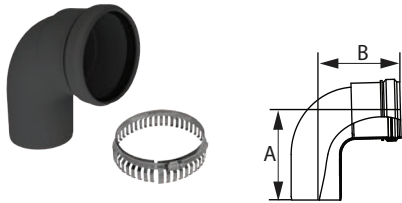

Offsets around obstructions as needed. Made of UV resistant polypropylene. May be used for terminations. Order Bird Guard Screen to protect opening when used as termination. Includes 1 Locking Clamp.

SIZE	ORDER #	STOCK #	A	B
2"   60mm	2PPS-E90BC	810014484	4"   100mm	4"   100mm
3"   80mm	3PPS-E90BC	810014539	4 5/16"   110mm	4 5/16"   110mm
4"   100mm	4PPS-E90BC	810014597	4 1/2"   115mm	4 1/2"   115mm
6"   150mm	6PPS-E90BC	810014691	7 1/4"   183mm	6 1/2"   166mm

### Black UV Resistant Extended 90° Elbow

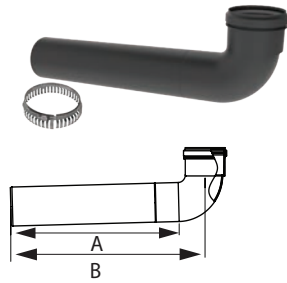

Made of UV resistant polypropylene. May be used for terminations. Order Bird Guard Screen to protect opening when used as termination. Includes 1 Locking Clamp.

SIZE	ORDER #	STOCK #	A	B
2"   60mm	2PPS-E90EBC	810014485	14"   358mm	16"   405mm
3"   80mm	3PPS-E90EBC	810014540	14 1/4"   360mm	16 5/16"   415mm
4"   100mm	4PPS-E90EBC	810014598	14 1/4"   360mm	16 1/2"   420mm

### Condensate Drain

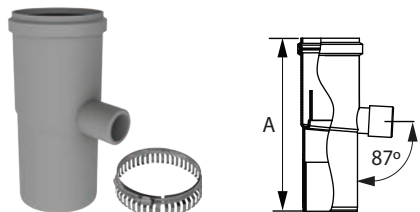

Use to remove corrosive condensates from within the vent system. 1-1/4" OD drain outlet. Includes 1 Locking Clamp. For 8" systems - use 8PPS-T with 8PPS-CD Tee Cap Drain.

SIZE	ORDER #	STOCK #	A	SIZE	ORDER #	STOCK #	A
2"   50mm	2PPS-CDC	810014502	7"   180mm	5"   130mm	5PPS-CDC	810014666	7"   180mm
3"   80mm	3PPS-CDC	810014557	7"   180mm	6"   150mm	6PPS-CDC	810014699	7"   180mm
4"   100mm	4PPS-CDC	810014618	7"   180mm				

### Tee Cap

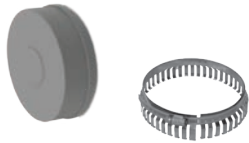

Use cap on Tees, Condensate Drain or on other components where a cap is needed. Includes 1 Locking Clamp.

SIZE	ORDER #	STOCK #	SIZE	ORDER #	STOCK #
2"   60mm	2PPS-C	810004103	5"   130mm	5PPS-C	810004226
3"   80mm	3PPS-C	810004142	6"   150mm	6PPS-C	810006177
4"   100mm	4PPS-C	810004185	8"   200mm	8PPS-C	810004292

### Tee Cap w/ Condensate Drain



Use cap on Tees, Condensate Drain or on other components where a cap is needed. Includes 1 Locking Clamp.

SIZE	ORDER #	STOCK #
8"   200mm	8PPS-CD	810004291

### Tee w/ Cap

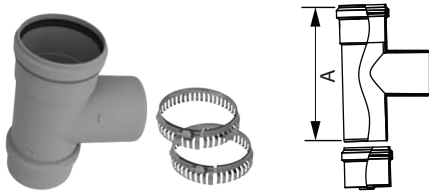

Use for a 90° offset or to combine connections. Includes 2 Locking Clamps.

SIZE	ORDER #	STOCK #	A	SIZE	ORDER #	STOCK #	A
2"   60mm	2PPS-TC	810014493	7"   180mm	5"   130mm	5PPS-TC	810014661	11"   280mm
3"   80mm	3PPS-TC	810014530	7 7/8"   200mm	6"   150mm	6PPS-TC	810014693	11"   280mm
4"   100mm	4PPS-TC	810014607	8 1/4"   220mm	8"   200mm	8PPS-TC	810014810	13 1/4"   350mm

### Black UV Resistant Tee

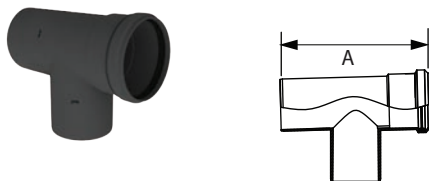

Use as a termination. Made of UV resistant polypropylene. Gasket not included. Bird Screen sold separately.

SIZE	ORDER #	STOCK #	A
2"   60mm	2PPS-TBC	810014494	7"   180mm
3"   80mm	3PPS-TBC	810014549	7 7/8"   200mm
4"   100mm	4PPS-TBC	810014608	8 1/4"   220mm

### Black Termination Tee

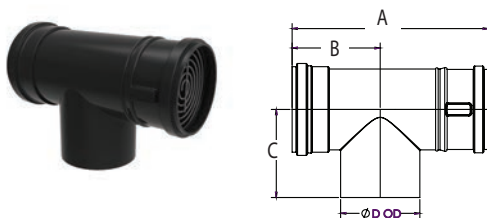

Use as a termination. Manufactured with two female ends to accept Bird Screen on both ends. Use bird screen to protect openings. Made of UV resistant polypropylene. Includes 2 Bird Guard Screens. For Single Wall Vertical Terminations see pg 13.

SIZE	ORDER #	STOCK #	A	B	C	D
2"   60mm	2PPS-TTBL	810014459	8"	3 1/2"	3 1/2"	2 3/8"
3"   80mm	3PPS-TTBL	810014460	8 5/8"	4"	3 3/8"	3 1/8"
4"   100mm	4PPS-TTBL	810014461	9 3/4"	4 3/8"	4 3/8"	3 7/8"

### Black UV Resistant Termination Tee



Use as a termination. Manufactured with two female ends to accept Bird Screen on both ends. Use bird screen to protect openings. Made of UV resistant polypropylene. Includes 2 Bird Guard Screens.

SIZE	ORDER #	STOCK #
6"   150mm	6PPS-TTBC	810014696



### Black Wall Plate

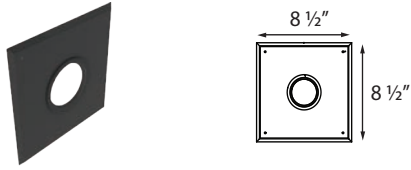

Use to trim wall penetration. Painted black metal with gasket.

SIZE	ORDER #	STOCK #	SIZE	ORDER #	STOCK #
2"   60mm	2PPS-WPB	810004112	4"   100mm	4PPS-WPB	810004195
3"   80mm	3PPS-WPB	810004152			

### Black Wall Plate for Twin Pipes

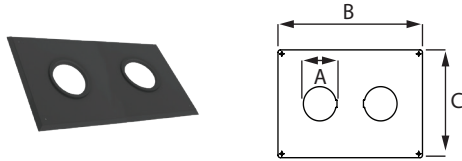

Use to trim wall penetration when using two pipes. Painted black metal with gaskets.

SIZE	ORDER #	STOCK #	A	B	C
2"   60mm	2PPS-WPT	810004113	2"   60mm	11 7/8"   302mm	8 1/2"   216mm
3"   80mm	3PPS-WPT	810004153	3"   80mm	11 7/8"   302mm	8 1/2"   216mm
4"   100mm	4PPS-WPT	810004196	4"   100mm	12 7/8"   327mm	8 1/2"   216mm

### Tee w/ Drain Cap

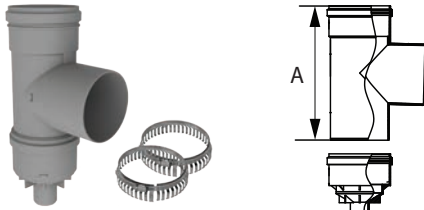

Use to remove corrosive condensates from within the vent system at the bottom of a vertical stack. 1-1/4" OD drain outlet. Includes 2 Locking Clamps.

SIZE	ORDER #	STOCK #	SIZE	ORDER #	STOCK #
2"   60mm	2PPS-TCDC	810014495	5"   130mm	5PPS-TCDC	810014662
3"   80mm	3PPS-TCDC	810014550	6"   150mm	6PPS-TCDC	810014694
4"   100mm	4PPS-TCDC	810014609	8"   200mm	8PPS-TCDC	810014811

### Reducer

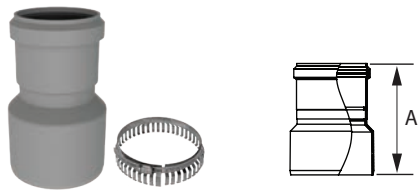

Use to transition the vent system to a smaller diameter. Includes 1 Locking Clamp.

SIZE	ORDER #	STOCK #	A
3" - 2"   80mm - 60mm	3PPS-R2L	810009714	5"   130mm
4" - 3"   100mm - 80mm	4PPS-R3L	810009746	5"   130mm
5" - 4"   130mm - 100mm	5PPS-R4L	810009764	7 5/8"   193mm
6" - 5"   150mm - 130mm	6PPS-R5L	810009785	7 3/4"   197mm
8" - 6"   200mm - 150mm	8PPS-R6L	810009801	5 15/16"   150mm

### Increaser



Use to transition the vent system to a larger diameter. Install in vertical orientation only. Includes 1 Locking Clamp.

SIZE	ORDER #	STOCK #	A
2" - 3"   60mm - 80mm	2PPS-X3L	810009694	4 5/16"   110mm
3" - 4"   80mm - 100mm	3PPS-X4L	810009722	4 5/16"   110mm
4" - 5"   100mm - 130mm	4PPS-X5L	810009754	4 5/16"   110mm
5" - 6"   130mm - 150mm	5PPS-X6L	810009771	4 5/16"   110mm
6" - 8"   150mm - 200mm	6PPS-X8L	810009792	5 3/4"   145mm

### 6" Fulton EDR 750-1500 to 6" PolyPro Appliance Adapter

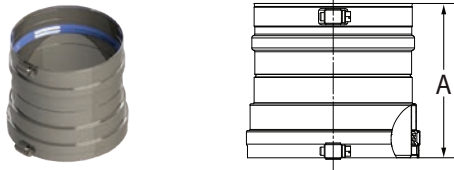

Use to connect 6" diameter PolyPro vent system to the Fulton EDR 750-1600 model appliance. No adapter connector and/or locking Clamp required. Hose clamps on both ends.

SIZE	ORDER #	STOCK #	A
6"   150mm	6PPS-FULTEDR-6PPF	810010023	5 15/16"   151mm

### 8" Fulton EDR 2000 to 8" PolyPro Appliance Adapter

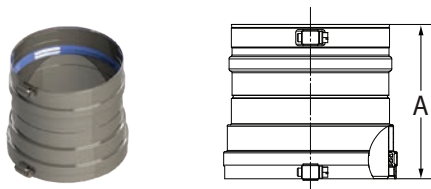

Use to connect 8" diameter PolyPro vent system to the Fulton EDR 2000 model appliance. No adapter connector and/or locking Clamp required. Hose clamps on both ends.

SIZE	ORDER #	STOCK #	A
8"   200mm	8PPS-FULTEDR-8PPF	810010025	5 15/16"   151mm

### Appliance Adapter for PVC Pipe



Use to connect PolyPro vent system to an appliance outlet. Double female adapter - one end accepts PVC male pipe and the other accepts PolyPro male pipe. Locking Clamp is required on the female PP end.

SIZE	ORDER #	STOCK #
3"   80mm	3PPS-AD-M	810007169
4"   100mm	4PPS-AD-M	810007170

### Appliance Adapter for PVC Coupler



Use to adapt rigid PolyPro pipe length to the inside of the PVC/CPVC coupler or other plastic/metal appliance outlet. Must be used with Adapter Connector for flue gas. Includes 1 Adapter Connector clamp.

SIZE	ORDER #	STOCK #	SIZE	ORDER #	STOCK #
2"   60mm	2PPS-ADL	810009672	4"   100mm	4PPS-ADL	810009728
3"   80mm	3PPS-ADL	810009699			

### Appliance Adapter for Centrotherm

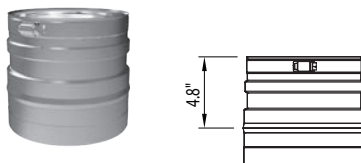

Use to adapt from 160mm (6") (Non-DuraVent) PolyPro to DuraVent's 150mm (6") PolyPro.

SIZE	ORDER #	STOCK #
6"   150mm	6PPS-160mm-6PP	810016446
6"   150mm	6PPS-160mm-6PPB	810016447

### VSM Adapter

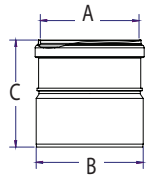

Use to adapt from 110mm (4") (Non-DuraVent) PolyPro to DuraVent's 100mm (4") PolyPro. Adapter Connector sold separately.

SIZE	ORDER #	STOCK #	A	B	C
4"   100 mm	PPS-VSM-AD	810006942	4"   102mm	4 3/8"   110mm	4 3/8"   110mm

### Female Appliance Adapter

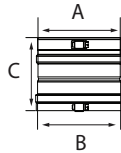

Use to connect PolyPro to a nominal sized pipe with a smooth male end outlet. No adapter connector and/or Locking Clamp required. Hose clamps on both ends.

SIZE	ORDER #	STOCK #	A	B	C
3"   80mm	FSAAU3-3PP	810004171	3 1/5"   81mm	3"   80mm	5"   130mm
4"   100mm	FSAAU4-4PP	810004210	4"   100mm	4"   100mm	5"   130mm
6"   150mm	FSAAU6-6PP	810004283	5 15/16"   151mm	6"   150mm	5"   130mm
8"   200mm	FSAAU8-8PP	810004312	7 15/16"   199mm	8"   200mm	5"   130mm

### Male PVC Appliance Adapter

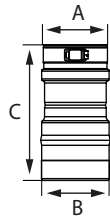

Use to connect PolyPro vent system to a standard stainless steel appliance outlet equipped with an integrated hose clamp and gasket. Must be used with Adapter Connector for flue gas, unless a clamp is supplied on the appliance outlet. Same O.D. as PVC.

SIZE	ORDER #	STOCK #	A	B	C
3" to 2"   80mm	3PPS-03PVCM-2PPF	810007345	2 2/5"   61mm	3 1/2"   89mm	6"   150mm
3" to 3"   80mm	3PPS-03PVCM-3PPF	810004167	3 3/16"   81mm	3 1/2"   89mm	6 13/16"   173mm
4"   100mm	4PPS-04PVCM-4PPF	810004207	4"   102mm	4 1/2"   114mm	6 13/16"   173mm
5"   125mm	5PPS-05PVCM-5PPF	810004245	5 3/16"   132mm	5 9/16"   141mm	6 13/16"   173mm
6"   150mm	6PPS-06PVCM-6PPF	810004281	6"   152mm	6 5/8"   168mm	6 13/16"   173mm
8"   200mm	8PPS-08PVCM-8PPF	810004310	8"   203mm	8 5/8"   219mm	6 15/16"   176mm

### Female PVC Appliance Adapter

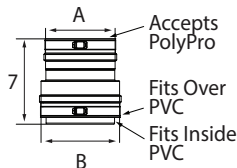

Use to directly connect PolyPro to a male PVC Pipe appliance outlet. Seals on the O.D. of the PVC pipe and has a clamp. No adapter connector and/or Locking Clamp required.

SIZE	ORDER #	STOCK #	A	B
5"   130mm	5PPS-05PVCF-5PPF	810004244	5"   130mm	5 11/16"   144mm
6"   150mm	6PPS-06PVCF-6PPF	810004280	5 15/16"   151mm	6 11/16"   170mm
8"   200mm	8PPS-08PVCF-8PPF	810004309	7 15/16"   132mm	7 7/8"   200mm

### FasNSeal Adapter

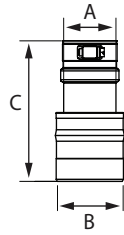

Use to transition from FasNSeal vent system to PolyPro vent system. Can be used as an appliance adapter or inline. No Locking Clamp required.

SIZE	ORDER #	STOCK #	A	B	C
3"   80mm	FSA-03M-2PPF	810004170	2 3/8"   60mm	3"   76mm	6 1/8"   156mm
3"   80mm	FSA-03M-3PPF	810004169	3 3/16"   81mm	3"   76mm	5 15/16"   151mm
4"   100mm	FSA-04M-4PPF	810004209	4"   100mm	4"   100mm	5 15/16"   151mm
5"   130mm	FSA-05M-5PPF	810004247	5 3/16"   132mm	5"   130mm	5 15/16"   151mm
6"   150mm	FSA-06M-6PPF	810007030	5 15/16"   151mm	6"   150mm	6"   150mm
7"   178mm	FSA-07M-6PPF	810004463	6 13/16"   173mm	7"   178mm	6 5/16"   160mm
8"   200mm	FSA-08M-8PPF	810007031	8"   200mm	8"   200mm	6"   150mm

### PolyPro-To-FasNSeal Adapter

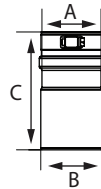

Use to transition from PolyPro vent system to FasNSeal vent system or to connect a metric appliance to FasNSeal. Can be used as an appliance adapter or inline. Includes 1 Locking Clamp.

SIZE	ORDER #	STOCK #	A	B	C
3"   80mm	3PPS-ADM-03FNSFC	810014536	3"   80mm	3 1/8"   79mm	3 13/16"   97mm
4"   100mm	4PPS-ADM-04FNSFC	810014593	4"   100mm	3 1 5/16"   99mm	5 15/16"   151mm
5"   130mm	5PPS-ADM-05FNSFC	810014655	5"   130mm	5 1/8"   131mm	5 15/16"   151mm
6"   150mm	6PPS-ADM-06FNSFC	810014686	6"   150mm	5 15/16"   151mm	7"   178mm
8"   200mm	8PPS-ADM-08FNSFC	810014804	8"   200mm	7 7/8"   199mm	7"   178mm

### Adapter Connector

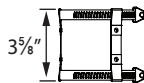

Use to secure PolyPro pipe to PVC/CPVC coupler or appliance outlet. Universal size for 2-4 inch and 5-8 inch systems. DuraVent requires its use with flue gas applications and recommends it with air intake applications.

SIZE	ORDER #	STOCK #	SIZE	ORDER #	STOCK #
2" - 4"   60mm - 100mm	PPS-PAC	810004128	5" - 8"   130mm - 200mm	PPS-PACL	810004243

### Wall Strap - Metal

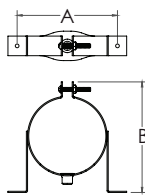

Use to support single-wall and concentric offsets and pipe used in vertical rise or horizontal runs as per installation instructions. Wall Strap legs can be rotated up to 360° for versatility. Accepts standard 3/8" all-thread. Available in galvanized or stainless steel metals. Note: Vent pipe must be supported at least every 10 feet (3m) vertically. Horizontal or sloped sections of vent pipe require a wall strap on each pipe section.

SIZE	GALVANIZED		A	B	SIZE	STAINLESS STEEL		A	B
	ORDER #	STOCK #				ORDER #	STOCK #		
2"   60mm	2PPS-WSM1	810014342	3 5/8"   92mm	4 7/8"   124mm	2"   60mm	2PPS-WSM-SS1	810014348	3 5/8"   92mm	4 7/8"   124mm
3"   80mm	3PPS-WSM1	810014343	4 3/8"   112mm	5 1/4"   133mm	3"   80mm	3PPS-WSM-SS1	810014349	4 3/8"   112mm	5 1/4"   133mm
4"   100mm	4PPS-WSM1	810014344	5 1/8"   130mm	5 5/8"   143mm	4"   100mm	4PPS-WSM-SS1	810014350	5 1/8"   130mm	5 5/8"   143mm
5"   130mm	5PPS-WSM1	810014345	6 3/8"   162mm	6 3/4"   171mm	5"   130mm	5PPS-WSM-SS1	810014351	6 3/8"   162mm	6 3/4"   171mm
6"   150mm	6PPS-WSM1	810014346	7 1/8"   181mm	7 5/8"   194mm	6"   150mm	6PPS-WSM-SS1	810014352	7 1/8"   181mm	7 5/8"   194mm
8"   200mm	8PPS-WSM1	810014347	9 1/8"   232mm	9 5/8"   245mm	8"   200mm	8PPS-WSM-SS1	810014353	9 1/8"   232mm	9 5/8"   245mm

### Locking Clamp



Use to secure two sections of uncut pipe together. Required to comply with ULC S636 listed installations.

SIZE	ORDER #	STOCK #	SIZE	ORDER #	STOCK #
2"   60mm	2PPS-LC	810014835	5"   130mm	5PPS-LC	810014838
3"   80mm	3PPS-LC	810014836	6"   150mm	6PPS-LC	810014839
4"   100mm	4PPS-LC	810014837	8"   200mm	8PPS-LC	810014840

### Locking Band Clamp



Use for connecting cut sections of pipe together. Also convenient for connection pipe sections used in extended vertical installations.

SIZE	ORDER #	STOCK #	A	B
2"   60mm	2PPS-LBC	810007146	2 3/8"   60mm	2 1/2"   64mm
3"   80mm	3PPS-LBC	810007147	3 1/8"   80mm	2 1/2"   64mm
4"   100mm	4PPS-LBC	810007148	4"   100mm	2 1/2"   64mm
5"   130mm	5PPS-LBC	810004242	5 1/8"   130mm	2 1/2"   64mm
6"   150mm	6PPS-LBC	810004278	6 1/8"   156mm	2 1/2"   64mm
8"   200mm	8PPS-LBC	810004306	8 1/8"   207mm	2 1/2"   64mm

### Firestop Spacer

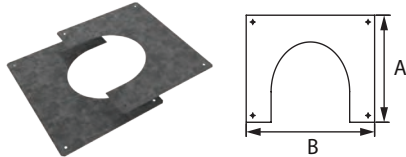

Use when penetrating floor levels. Two piece design for easier installation.

SIZE	SINGLE-WALL PIPE		A	B
	ORDER #	STOCK #		
2"   60mm	2PPS-FSS	810004115	4"   100mm	7"   178mm
3"   80mm	3PPS-FSS	810004155	4"   100mm	7"   178mm
4"   100mm	4PPS-FSS	810004198	4"   100mm	7"   178mm
5"   130mm	5PPS-FSS	810004234	8 1/8"   206mm	10"   254mm
6"   150mm	6PPS-FSS	810004269	7 3/4"   197mm	9 3/4"   248mm
8"   200mm	8PPS-FSS	810004298	10 1/2"   267mm	12 3/4"   324mm

### Storm Collar



Use to create a weather tight seal between the pipe and flashing. To be used with Black Termination Tee.

SIZE	ORDER #	STOCK #
2"	FSCPP2	810014467
3"	FSCPP3	810014468
4"	FSCPP4	810014469

### Tall Cone Flashing

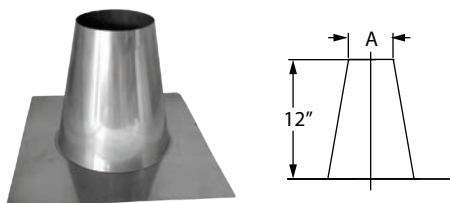

Use to create a weather-tight penetration where the vent passes through a flat roof. Roof Jack and Storm Collar required. To be used with Black Termination Tee.

SIZE	ORDER #	STOCK #	A
2"	FSAFPP2	810014470	4 1/8"
3"	FSAFPP3	810014471	5 1/8"
4"	FSAFPP4	810014472	6 1/8"

### Steep Roof Flashing

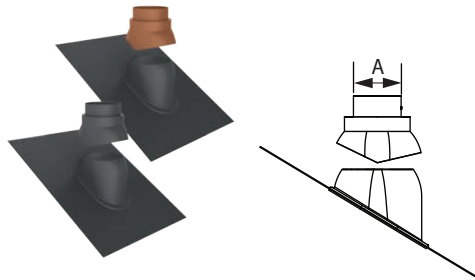

Use to weather proof penetration of vent through the roof. For concentric pipe. Made of polypropylene. Adjusts from 5/12 to 12/12. Black or terra-cotta. UV resistant.

SIZE	BLACK		A
	ORDER #	STOCK #	
2" x 4"   60mm x 100mm	2PPS-F12	810004118	4"   100mm
3" x 5"   80mm x 130mm	3PPS-F12	810004158	5"   130mm
4" x 6"   100mm x 150mm	4PPS-F12	810004201	6"   150mm
SIZE	TERRA-COTTA		A
	ORDER #	STOCK #	
2" x 4"   60mm x 100mm	2PPS-F12-TC	810004119	4"   100mm
3" x 5"   80mm x 130mm	3PPS-F12-TC	810004159	5"   130mm
4" x 6"   100mm x 150mm	4PPS-F12-TC	810004202	6"   150mm

### Flat Roof Flashing

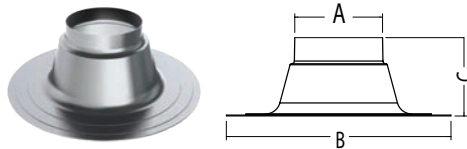

Use to weather-proof the penetration of vent pipe through the roof. For use with concentric terminations only.

SIZE	ORDER #	STOCK #	A	B	C
2" x 4"   60mm x 100mm	2PPS-FF	810004116	4 5/8"   117mm	13 3/4"   349mm	5 7/8"   149mm
3" x 5"   80mm x 130mm	3PPS-FF	810004156	5 3/8"   137mm	15 3/8"   391mm	5 7/8"   149mm
4" x 6"   100mm x 150mm	4PPS-FF	810004199	6 5/8"   168mm	16 7/8"   429mm	5 7/8"   149mm

### Twin Pipe Termination

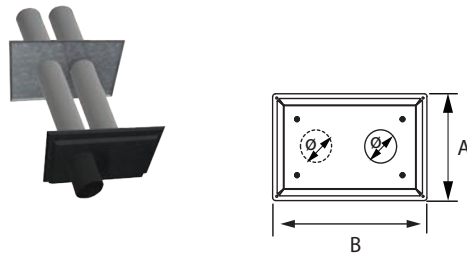

Use to terminate horizontally with two single-wall PolyPro pipes for intake and exhaust. Simple design ensures adequate separation of intake air from exhaust. Termination is painted black. Includes black UV resistant polypropylene exhaust nozzle equipped with Bird Screen, interior wall plate, and two 12" pipe lengths.

SIZE	ORDER #	STOCK #	A	B
2"   60mm	2PPS-HTPC	810014491	8 1/2"   216mm	11 7/8"   302mm
3"   80mm	3PPS-HTPC	810014547	8 1/2"   216mm	11 7/8"   302mm
4"   100mm	4PPS-HTPC	810014605	8 1/2"   216mm	12 1/4"   311mm

### Single Horizontal Termination

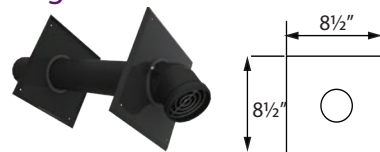

Use to terminate horizontally with one single-wall PolyPro pipe. Termination and wall plate can be rotated to suit application. Elbow is UV resistant black with bird screen. Also includes interior wall plate, and 14" length of pipe.

SIZE	ORDER #	STOCK #
2"   60mm	2PPS-HSTC	810014490
3"   80mm	3PPS-HSTC	810014546

### Lochinvar Horizontal Termination Kit



Use to adapt PolyPro to the IpeX 636 low profile termination. Kit includes 14" pipe welded to an adapter and metal backing plate. Check with appliance manufacturer for approval. (Outer IPEX termination cap not included. Supplied by others.)

SIZE	ORDER #	STOCK #	A		B	
2"   60mm	2PPS-HLKC	810014489	14 3/16"	360mm	8 5/8"	220mm
3"   80mm	3PPS-HLKC	810014545	14 3/16"	360mm	8 5/8"	220mm
4"   100mm	4PPS-HLKC	810014604	14 3/16"	360mm	8 5/8"	220mm

### Vertical Termination Extension

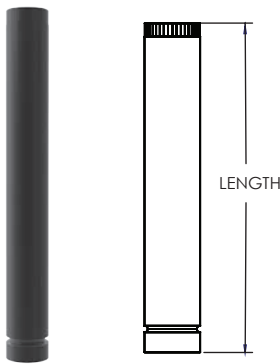

Used to extend the vertical termination an additional 1 meter (39") above the roof. Requires a 1 meter (\*PPC-P1000) concentric vent length (not included).

SIZE	ORDER #	STOCK #
2" x 4"   60mm x 100mm	2PPS-VTX	810016965
3" x 5"   80mm x 125mm	3PPS-VTX	810016966
4" x 6"   100mm x 150mm	4PPS-VTX	810016967

### Vertical Termination Cap - Concentric

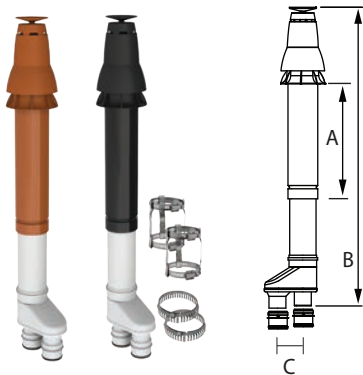

Use for concentric vertical terminations. Includes 2 appliance adapters and co-linear adapter. Black or terra-cotta cap. UV resistant. No storm collar required when installed with factory PolyPro flashing. Includes 2 Locking Clamps and 2 Adapter Connector clamps.

SIZE	BLACK		A	B	C
	ORDER #	STOCK #			
2" x 4"   60mm x 100mm	2PPS-VKC	810014497	18"   460mm	50 1/4"   1280mm	4 3/4"   121mm
3" x 5"   80mm x 125mm	3PPS-VKC	810014553	23"   580mm	53 1/4"   1354mm	4 3/4"   121mm
4" x 6"   100mm x 150mm	4PPS-VKC	810014611	23"   580mm	68 1/4"   1735mm	5 1/2"   140mm
SIZE	TERRA-COTTA		A	B	C
	ORDER #	STOCK #			
2" x 4"   60mm x 100mm	2PPS-VK-TCC	810014498	18"   460mm	50 1/4"   1280mm	4 3/4"   121mm
3" x 5"   80mm x 125mm	3PPS-VK-TCC	810014554	23"   580mm	53 1/4"   1354mm	4 3/4"   121mm
4" x 6"   100mm x 150mm	4PPS-VK-TCC	810014612	23"   580mm	68 1/4"   1735mm	5 1/2"   140mm

### Vertical Termination Kit Without Adapters

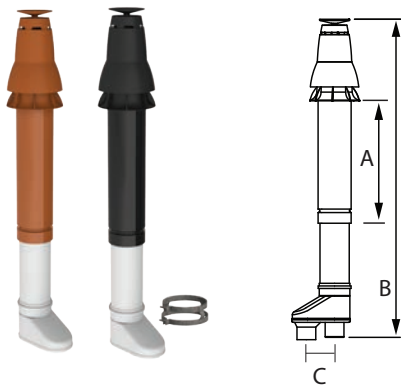

Use for concentric vertical terminations. Includes co-linear adapter and 1 Locking Band Clamp. Black or terra-cotta cap. UV resistant. No storm collar required when installed with factory PolyPro flashing.

SIZE	BLACK		A	B	C
	ORDER #	STOCK #			
2" x 4"   60mm x 100mm	2PPS-VKC-N	810014525	18"   460mm	50 1/4"   1280mm	4 3/4"   121mm
3" x 5"   80mm x 130mm	3PPS-VKC-N	810014584	23"   580mm	53 1/4"   1354mm	4 3/4"   121mm
4" x 6"   100mm x 150mm	4PPS-VKC-N	810014649	23"   580mm	68 1/4"   1735mm	5 1/2"   140mm
SIZE	TERRA-COTTA		A	B	C
	ORDER #	STOCK #			
2" x 4"   60mm x 100mm	2PPS-VK-TCC-N	810014526	18"   460mm	50 1/4"   1280mm	4 3/4"   121mm
3" x 5"   80mm x 130mm	3PPS-VK-TCC-N	810014585	23"   580mm	53 1/4"   1354mm	4 3/4"   121mm
4" x 6"   100mm x 150mm	4PPS-VK-TCC-N	810014650	23"   580mm	68 1/4"   1735mm	5 1/2"   140mm

### Horizontal Termination Kit - Concentric

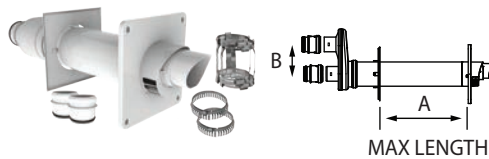

Use for concentric horizontal terminations. Includes 2 appliance adapters, white wall plate, white firestop, and co-linear adapter. White Termination with Bird Guard Screen. UV resistant. Inner plate is 8 5/8" (220mm) square, outer plate is 9 7/16" (240mm) square for all flue sizes. Includes 2 Locking Clamps and two Adapter Connector clamps. Adapters included to transition from PVC appliance outlet to twin pipe PolyPro.

SIZE	ORDER #	STOCK #	A	B
2" x 4"   60mm x 100mm	2PPS-HKC	810014488	13 3/4"   350mm	4 3/4"   121mm
3" x 5"   80mm x 130mm	3PPS-HKC	810014544	13"   330mm	4 3/4"   121mm
4" x 6"   100mm x 150mm	4PPS-HKC	810014603	13 3/4"   350mm	5 1/2"   140mm

### Horizontal Termination Kit Without Adapters

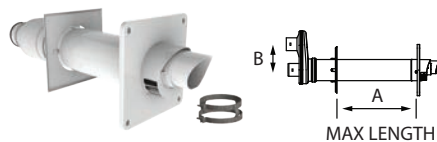

Use for concentric horizontal terminations. Includes white wall plate, 1 Locking Band Clamp, white firestop, and co-linear adapter. White Termination with Bird Guard Screen. UV resistant. Inner plate is 8 5/8" (220mm) square, outer plate is 9 7/16" (240mm) square for all flue sizes.

SIZE	ORDER #	STOCK #	A	B
2" x 4"   60mm x 100mm	2PPS-HKC-N	810014527	13 3/4"   350mm	4 3/4"   121mm
3" x 5"   80mm x 130mm	3PPS-HKC-N	810014586	13"   330mm	4 3/4"   121mm
4" x 6"   100mm x 150mm	4PPS-HKC-N	810014651	13 3/4"   350mm	5 1/2"   140mm

### Bird Guard Screen



Use to protect venting system from birds and rodents. Spring-loaded design inserts within female end of pipe in place of gasket. Stainless steel.

SIZE	ORDER #	STOCK #	SIZE	ORDER #	STOCK #
2"   60mm	2PPS-BG	810004341	4"   100mm	4PPS-BG	810004367
3"   80mm	3PPS-BG	810004355	6"   150mm	6PPS-BG	810004276



### EPDM Replacement Gasket



Use as a replacement gasket for rigid PolyPro products. Available in packs of 12 for sizes 2" - 4". Available in packs of 6 for sizes 5" - 8".

SIZE	ORDER #	STOCK #	SIZE	ORDER #	STOCK #
2"   60mm	2PPS-GA	810004124	5"   130mm	5PPS-GA	810004237
3"   80mm	3PPS-GA	810004164	6"   150mm	6PPS-GA	810004272
4"   100mm	4PPS-GA	810004204	8"   200mm	8PPS-GA	810004303

### Viton Replacement Gasket



Alternative gasket material for oil fuel appliance applications. Available in packs of 12 for sizes 2" - 4". Available in packs of 6 for sizes 5" - 8".

SIZE	ORDER #	STOCK #	SIZE	ORDER #	STOCK #
2"   60mm	2PPS-GAV	810004126	5"   130mm	5PPS-GAV	810004238
3"   80mm	3PPS-GAV	810004165	6"   150mm	6PPS-GAV	810004273
4"   100mm	4PPS-GAV	810004205	8"   200mm	8PPS-GAV	810004304

## PolyPro Commercial Venting Components

### Vertical Termination for Commercial Systems

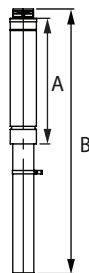

Exhaust termination for vertical through-the-roof applications. PolyPro pipe is protected by a sturdy outer metal pipe and integrated cap. Painted with a durable, powder coated black finish. Includes support hardware.

To complete vertical termination for commercial systems, installation requires (1) variable pitch roof flashing, (1) support clamp, and (1) storm collar.

SIZE	ORDER #	STOCK #	A	B	O.D.
5"   130mm	5PPS-VTMC	810014664	29"   745mm	62"   1575mm	6 3/8"   162mm
6"   150mm	6PPS-VTMC	810014697	29"   741mm	62"   1575mm	7 1/4"   184mm
8"   200mm	8PPS-VTMC	810014813	32"   800mm	63"   1600mm	9 1/8"   232mm

### Variable Pitch Roof Flashing

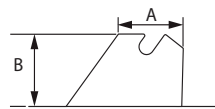
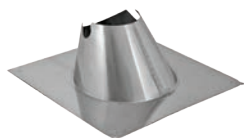

Use to weather-proof the penetration of vent pipe through the roof. For use with VTMC. For pitches of 0/12 - 9/12. Made of stainless steel.

SIZE	ORDER #	STOCK #	A	B
5"   130mm	FSVPF5	810003241	7"   178mm	7"   178mm
6"   150mm	FSVPF6	810003295	8"   200mm	7"   178mm
8"   200mm	FSVPF8	810003383	9"   228mm	7"   178mm

### Support Clamp

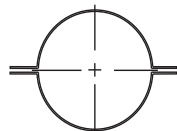

Use to position the Vertical Termination for Commercial Systems (VTM's) to the variable pitch roof flashing. The clamp is upsized one diameter to fit around the black metal outer pipe. The support claim rests in notched groove of variable pitch roof flashing.

SIZE	ORDER #	STOCK #	A
5"   130mm	FSCL6	810003288	1 1/2"   38mm
6"   150mm	FSCL7	810003332	1 1/2"   38mm
8"   200mm	FSCL9	810003414	1 1/2"   38mm

### Flat Roof Flashing

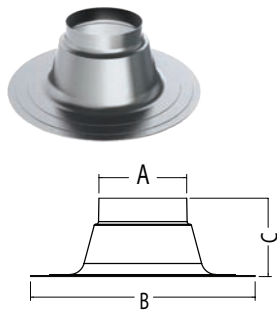

Use to weather-proof the penetration of vent pipe through the roof. For use with concentric terminations only.

SIZE	SINGLE-WALL PIPE		A	B	C
	ORDER #	STOCK #			
5"   130mm	5PPS-FF	810007171	6 1/8"   156mm	16 7/8"   429mm	5 7/8"   149mm
6"   150mm	6PPS-FF	810004268	6 3/4"   171mm	16 7/8"   429mm	5 7/8"   149mm
8"   200mm	8PPS-FF	810004302	8 7/8"   222mm	20 1/2"   521mm	6 7/8"   175mm

### Storm Collar



Clamps to black metal pipe covering support clamp and creating a weather tight seal above the flashing. For use with VTM.

SIZE	ORDER #	STOCK #
5"   130mm	FSCPP5	810007172
6"   150mm	FSCPP6	810007173
8"   200mm	FSCPP8	810007174

### Horizontal Termination for Commercial Systems

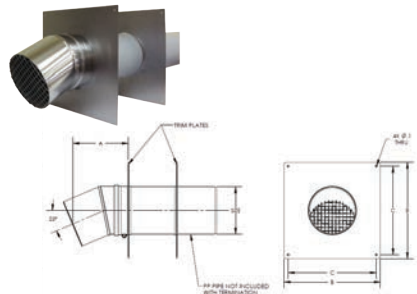

Use for through-the-wall horizontal terminations. Includes 23 degree termination elbow with integrated bird screen, inner and outer wall plates, and clamp for connecting to PolyPro pipe. No locking Clamp is required. All components are stainless steel.

SIZE	ORDER #	STOCK #	A	B	C
4"   100mm	4PPS-HSTL	810009744	7 3/4"   197mm	10"   254mm	9"   230mm
5"   130mm	5PPS-HSTL	810009763	6 5/8"   168mm	12"   305mm	11"   280mm
6"   150mm	6PPS-HSTL	810009784	6 7/8"   172mm	12"   305mm	11"   280mm
8"   200mm	8PPS-HSTL	810009800	7"   178mm	14"   358mm	13"   330mm

## PolyPro Concentric Venting Components

### Concentric Vent Length



Use to vent condensing appliances.

SIZE	ORDER #	STOCK #	A	B	C
2" x 4"   60mm x 100mm	2PPC-P500	810005200	19 1/4"   490mm	2 1/4"   60mm	3 7/8"   100mm
2" x 4"   60mm x 100mm	2PPC-P1000	810005199	39"   990mm	2 1/4"   60mm	3 7/8"   100mm
3" x 5"   80mm x 130mm	3PPC-P500	810005869	19 1/4"   490mm	3"   80mm	4 7/8"   125mm
3" x 5"   80mm x 130mm	3PPC-P1000	810005868	39"   990mm	3"   80mm	4 7/8"   125mm
4" x 6"   100mm x 150mm	4PPC-P500	810005981	19 1/4"   490mm	3 3/4"   100mm	5 7/8"   150mm
4" x 6"   100mm x 150mm	4PPC-P1000	810005980	39"   990mm	3 3/4"   100mm	5 7/8"   150mm

### Telescoping Vent Length



Use to add length to a concentric vent system.

SIZE	ORDER #	STOCK #	A	B	C	D
2" x 4"   60mm x 100mm	2PPC-TA	810005201	2 1/4"   60mm	3 7/8"   100mm	10 3/8"   265mm	15 7/8"   405mm
3" x 5"   80mm x 130mm	3PPC-TA	810005870	3"   80mm	4 7/8"   125mm	11"   280mm	15 1/2"   395mm
4" x 6"   100mm x 150mm	4PPC-TA	810005982	3 3/4"   100mm	5 7/8"   150mm	11"   280mm	15 1/2"   395mm

### Concentric Support Elbow



Use the support elbow to stabilize a vertical termination.

SIZE	ORDER #	STOCK #	A	B	C	D	E
2" x 4"   60mm x 100mm	2PPC-SE90	810013584	4"   100mm	4 7/8"   125mm	2 3/8"   60mm	3 7/8"   100mm	13 3/4"   350mm
3" x 5"   80mm x 130mm	3PPC-SE90	810013585	4 1/2"   115mm	5 1/4"   135mm	3 3/8"   80mm	4 7/8"   120mm	13 3/4"   350mm
4" x 6"   100mm x 150mm	4PPC-SE90	810013586	4 1/2"   115mm	5 3/8"   140mm	3 7/8"   100mm	5 7/8"   150mm	13 3/4"   350mm

### Concentric 45° Elbow



Use to vent condensing appliances. Offsets around obstructions as needed.

SIZE	ORDER #	STOCK #	A	B	C
2" x 4"   60mm x 100mm	2PPC-E45	810005195	6 1/4"   160 mm	2 1/4"   55 mm	3 7/8"   100 mm
3" x 5"   80mm x 130mm	3PPC-E45	810005864	6 3/4"   175 mm	3 1/4"   80 mm	4 7/8"   125 mm
4" x 6"   100mm x 150mm	4PPC-E45	810005976	11 1/4"   285 mm	4 1/4"   105 mm	5 7/8"   150 mm

### Concentric 90° Elbow



Use to vent condensing appliances. Offsets around obstructions as needed.

SIZE	ORDER #	STOCK #	A	B	C	D
2" x 4"   60mm x 100mm	2PPC-E90	810005196	4 7/8"   125mm	3 7/8"   100mm	2 1/4"   60mm	3 3/4"   95mm
3" x 5"   80mm x 130mm	3PPC-E90	810005865	5 1/4"   135mm	4 3/8"   110mm	3"   80mm	4 7/8"   125mm
4" x 6"   100mm x 150mm	4PPC-E90	810005977	5 1/2"   140mm	4 1/2"   115mm	3 3/4"   100mm	5 7/8"   150mm

### Condensate Trap



Use to remove corrosive condensates from within the vent system.

SIZE	ORDER #	STOCK #	A	B	C
2" x 4"   60mm x 100mm	2PPC-CT	810013421	7"   180mm	2 1/4"   60mm	3 7/8"   100mm
3" x 5"   80mm x 130mm	3PPC-CT	810013422	7"   180mm	3"   80mm	4 7/8"   120mm
4" x 6"   100mm x 150mm	4PPC-CT	810013423	7"   180mm	3 3/4"   100mm	5 3/4"   150mm

### Extension with SP



Use for combustion analysis testing without drilling holes into the vent system. Port cap is threaded for easy removal. Install immediately above the appliance.

SIZE	ORDER #	STOCK #	A	B	C
2" x 4"   60mm x 100mm	2PPC-ESP	810013418	6"   150mm	2 1/4"   60mm	3 7/8"   100mm
3" x 5"   80mm x 130mm	3PPC-ESP	810013419	6"   150mm	3"   80mm	4 7/8"   120mm
4" x 6"   100mm x 150mm	4PPC-ESP	810013420	6"   150mm	3 3/4"   100mm	5 7/8"   150mm

### Tee With Cover



Use for a 90° offset or to combine connections.

SIZE	ORDER #	STOCK #	A	B	C
2" x 4"   60mm x 100mm	2PPC-TCD	810013415	9"   230mm	2 1/4"   60mm	3 7/8"   100mm
3" x 5"   80mm x 130mm	3PPC-TCD	810013416	10 3/4"   275mm	3 1/8"   80mm	4 7/8"   125mm
4" x 6"   100mm x 150mm	4PPC-TCD	810013417	11 3/4"   300mm	3 7/8"   100mm	5 7/8"   150mm

### VSM Adapter

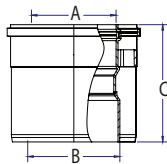

Use to adapt from 110mm x 150mm (4" x 6") (Non-DuraVent) PolyPro to DuraVent's 100mm x 150mm (4" x 6") concentricPolyPro.

SIZE	ORDER #	STOCK #	A	B	C
4" x 6"   100mm x 150mm	PPC-VSM-AD	810006939	4"   102mm	4 3/8"   110mm	5 1/2"   140mm

### Adapter Increaser

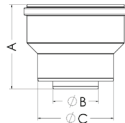

Use to transition the vent system to a larger diameter. Install in vertical orientation only.

SIZE	ORDER #	STOCK #	A	B	C
2" x 4"   60mm x 100mm	2PPC-X3INC	810005203	4 3/8"   110mm	2 1/4"   60mm	3 7/8"   100mm
3" x 5"   80mm x 130mm	2PPC-X4INC	810005204	4 7/8"   125mm	2 1/4"   60mm	3 7/8"   100mm
4" x 6"   100mm x 150mm	3PPC-X4INC	810005873	4 3/8"   110mm	3"   80mm	4 7/8"   125mm

### Concentric Reducer

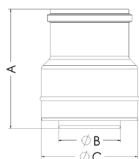

Use to transition the concentric vent system to a smaller diameter.

SIZE	ORDER #	STOCK #	A	B	C
3" x 5"   80mm x 130mm	3PPC-X2RED	810014341	6 1/8"   156mm	3 1/8"   80mm	5 7/8"   150mm

### Vertical Termination Extension

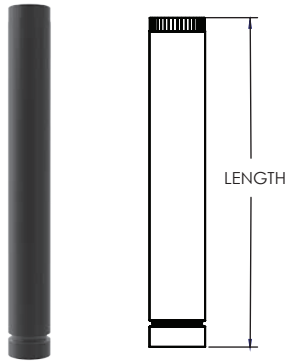

Used to extend the vertical termination an additional 1 meter (39") above the roof. Requires a 1 meter (\*PPC-P1000) concentric vent length (not included).

SIZE	ORDER #	STOCK #
2" x 4"   60mm x 100mm	2PPS-VTX	810016965
3" x 5"   80mm x 125mm	3PPS-VTX	810016966
4" x 6"   100mm x 150mm	4PPS-VTX	810016967

### Concentric Vertical Termination

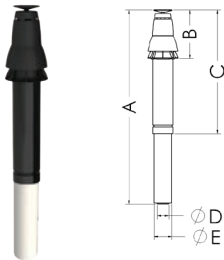

Use for concentric vertical terminations.

SIZE	ORDER #	STOCK #	A	B	C	D	E
2" x 4"   60mm x 100mm	2PPC-VCT	810005202	50 3/8"   1280mm	16 1/2"   420mm	27"   685mm	1 3/4"   60mm	3 7/8"   100mm
3" x 5"   80mm x 130mm	3PPC-VCT	810005871	53 3/8"   1355mm	16 1/2"   420mm	34"   860mm	2 3/4"   80mm	4 7/8"   125mm
4" x 6"   100mm x 150mm	4PPC-VCT	810005983	68 1/2"   1740mm	16 1/2"   420mm	36 5/8"   930mm	3 3/4"   100mm	5 7/8"   150mm

### Concentric Horizontal Termination

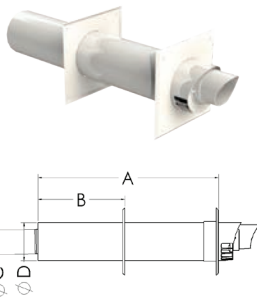

Use for concentric horizontal terminations.

SIZE	ORDER #	STOCK #	A	B	C	D
2" x 4"   60mm x 100mm	2PPC-HCT	810005197	23 3/4"   604mm	13 5/8"   347mm	3 7/8"   100mm	2 1/4"   60mm
3" x 5"   80mm x 130mm	3PPC-HCT	810005866	23 1/4"   591mm	11 1/4"   284mm	4 7/8"   125mm	3 1/8"   80mm
4" x 6"   100mm x 150mm	4PPC-HCT	810005978	23 1/4"   591mm	11 1/4"   284mm	5 7/8"   150mm	3 3/4"   100mm

### Concentric Horizontal Termination Kit

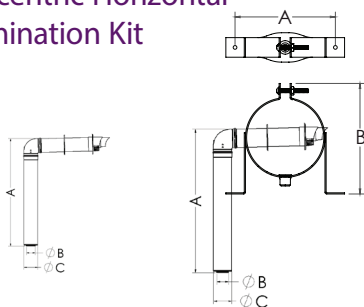

Use for concentric horizontal terminations. Includes 1 meter concentric vent length, 1 concentric 90° elbow, 1 concentric horizontal termination.

SIZE	ORDER #	STOCK #	A	B	C	WALL STRAPS
2" x 4"   60mm x 100mm	2PPC-HVKA	810005198	44"   1120mm	2"   55mm	3 7/8"   100mm	1
3" x 5"   80mm x 130mm	3PPC-HVKA	810005867	45"   1140mm	2 3/4"   75mm	4 7/8"   125mm	2
4" x 6"   100mm x 150mm	4PPC-HVKA	810005979	46"   1170mm	3 5/8"   95mm	5 7/8"   150mm	2

### Wall Strap - Metal



Use to support single-wall and concentric offsets and pipe used in vertical rise or horizontal runs as per installation instructions. Wall Strap legs can be rotated up to 360° for versatility. Accepts standard 3/8" all-thread. Available in galvanized or stainless steel metals. Note: Vent pipe must be supported at least every 10 feet (3m) vertically. Horizontal or sloped sections of vent pipe require a wall strap on each pipe section.

SIZE	ORDER #	STOCK #	A	B
2" x 4"   60mm x 100mm	2PPC-WSM1	810014412	5 1/8"   130mm	5 5/8"   143mm
3" x 5"   80mm x 130mm	3PPC-WSM1	810014413	6 1/8"   150mm	6 5/8"   170mm
4" x 6"   100mm x 150mm	4PPC-WSM1	810014414	7 1/8"   180mm	7 5/8"   190mm

### EPDM Replacement Gasket



Use as a replacement gasket for rigid PolyPro products. Available in packs of 12 for sizes 2" - 4".

SIZE	ORDER #	STOCK #
2" x 4"   60mm x 100mm	2PPS-GA	810004124
3" x 5"   80mm x 130mm	3PPS-GA	810004164
4" x 6"   100mm x 150mm	4PPS-GA	810004204

### Firestop Spacer

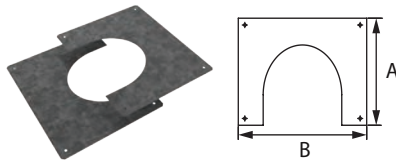

Use when penetrating floor levels. Two piece design for easier installation.

SIZE	ORDER #	STOCK #	A	B
2" x 4"   60mm x 100mm	2PPS-FS	810004114	7"   178mm	8 3/4"   223mm
3" x 5"   80mm x 130mm	3PPS-FS	810004154	7 7/8"   200mm	9 7/8"   251mm
4" x 6"   100mm x 150mm	4PPS-FS	810004197	7 7/8"   200mm	9 7/8"   251mm

### Flat Roof Flashing

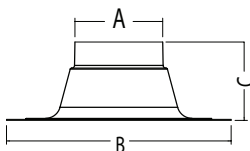

Use to weather-proof the penetration of vent pipe through the roof. For use with concentric terminations only.

SIZE	ORDER #	STOCK #	A	B	C
2" x 4"   60mm x 100mm	2PPS-FF	810004116	4 5/8"   117mm	13 3/4"   349mm	5 7/8"   149mm
3" x 5"   80mm x 130mm	3PPS-FF	810004156	5 3/8"   137mm	15 3/8"   391mm	5 7/8"   149mm
4" x 6"   100mm x 150mm	4PPS-FF	810004199	6 5/8"   168mm	16 7/8"   429mm	5 7/8"   149mm

### Adjustable Roof Flashing

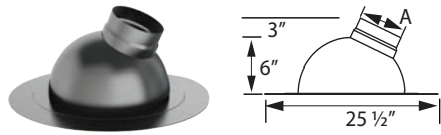

Use to weather proof penetration of vent through the roof. For concentric pipe. Made of aluminum. Adjusts from 0/12 to 5/12.

SIZE	ORDER #	STOCK #	A
2" x 4"   60mm x 100mm	2PPS-F5	810004117	4"   100mm
3" x 5"   80mm x 130mm	3PPS-F5	810004157	5"   130mm
4" x 6"   100mm x 150mm	4PPS-F5	810004200	6"   150mm

## PolyPro Double-Wall Components

### Pipe

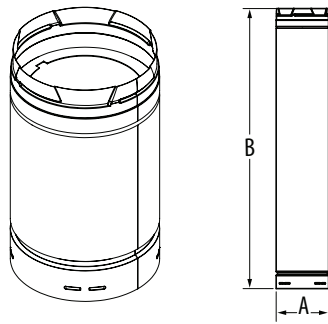

Galvanized outer jacket can be used as a conduit for single-wall PolyPro pipe. In exterior applications, provides protection from impact and UV light. Also provides some insulation value for use in colder climates. Can be field-painted if desired. Simple twist-lock assembly. To calculate installed length, subtract 1 1/2" for each joint. Includes internal metal support ring. PolyPro pipe sold separately.

SIZE	ORDER #	STOCK #	A	B
8"   200mm	8PPS-40DW	810009358	10"   254mm	40"
8"   200mm	8PPS-75DW	810009359	10"   254mm	75"

### Telescoping Pipe

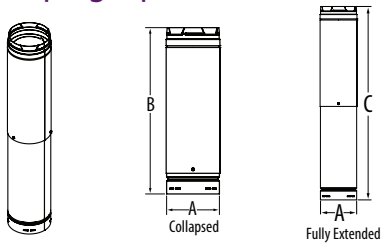

Matching telescoping section for galvanized outer jacket can be used to help achieve specific offset length or stack height. Minimum and maximum lengths vary according to diameter selected.

SIZE	ORDER #	STOCK #	A	B	C
8"   200mm	8PPS-40DWA	810009928	10"   254mm	24"	37 7/8"

### Appliance Adapter

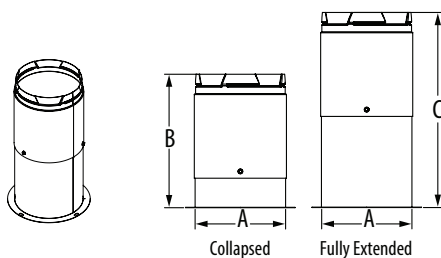

Adjustable Adapter with flange for galvanized outer jacket. Flange attaches to appliance cabinet with supplied screws. To calculate installed length, subtract 1 1/2" for each joint.

SIZE	ORDER #	STOCK #	A	B	C
8"   200mm	8PPS-ADDW	810009931	10"   254mm	9 3/4"	14 1/4"

### 90° Elbow

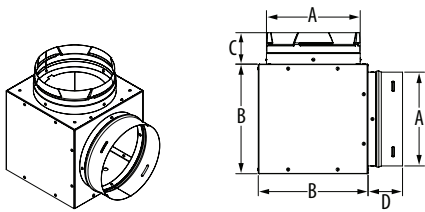

Adjustable Adapter with flange for galvanized outer jacket. Flange attaches to appliance cabinet with supplied screws. To calculate installed length, subtract 1 1/2" for each joint. Includes metal support ring.

SIZE	ORDER #	STOCK #	A	B	C	D
8"   200mm	8PPS-E90DW	810009361	10"   254mm	11 1/4"	2 3/8"	3"

### 45° Elbow

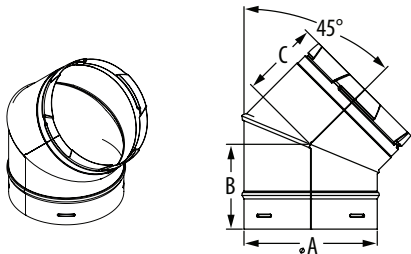

Galvanized outer jacket 45 degree elbow. Includes metal support ring. To calculate installed length, subtract 1 1/2" for each joint.

SIZE	ORDER #	STOCK #	A	B	C
8"   200mm	8PPS-E45DW	810009360	10"   254mm	4 1/2"   115mm	4 3/8"   110mm

### Wall Strap

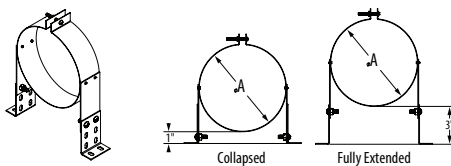

Use in interior or exterior installations to add lateral support to PolyPro DW Pipe. Adjusts to provide a 1"-3" clearance to combustibles and maintain proper slope. Additional clearance can be increased with optional PPS-WSMDW-EXT.

SIZE	ORDER #	STOCK #	A
8" - 10"   200mm - 254mm	8PPS-WSMDW	810009919	10"   254mm

### Wall Strap Extension

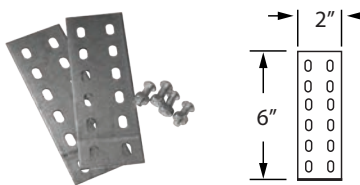

Use with Wall-Strap if additional mounting clearances or slope is required. Universal design fits all sizes.

SIZE	ORDER #	STOCK #
5" - 8"   130mm - 200mm	PPS-WSMDW-EXT	810010086

### Elbow Strap

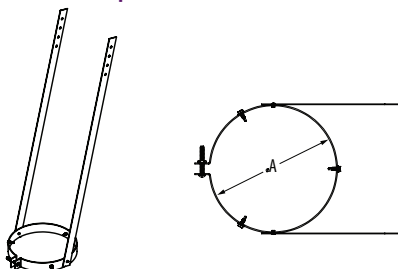

Used to support galvanized outer jacket when 45° elbows are used for offset purposes.

SIZE	ORDER #	STOCK #	A
8"   200mm	8PPS-ESDW	810009949	10"   254mm



### Adjustable Roof Flashing

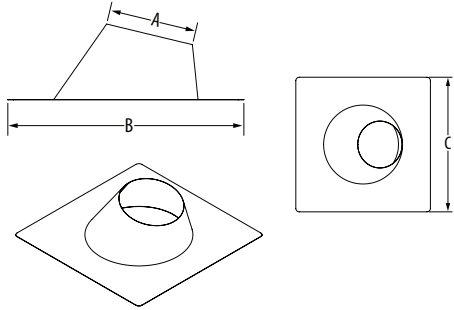

Use to weather-proof the penetration of the galvanized outer jacket through the roof. Made of galvalume.

SIZE	FLASHING		
	ORDER #	STOCK #	PITCH
8"   200mm	8PPS-FDW	810009925	0/12 - 6/12
SIZE	FLASHING STEEP ROOF		
	ORDER #	STOCK #	PITCH
8"   200mm	8PPS-FSRDW	810009934	7/12 - 12/12

### Storm Collar

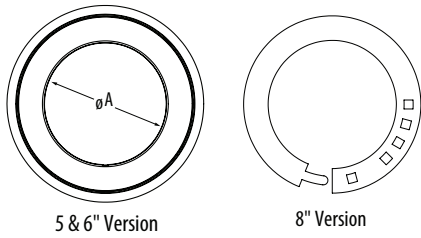

5 & 6" Version

8" Version

Used to maintain a weather tight, resistant seal between the galvanized outer jacket and flashing.

SIZE	ORDER #	STOCK #	A
8"   200mm	8PPS-SCDW	810009943	10"   254mm

### Firestop Spacer

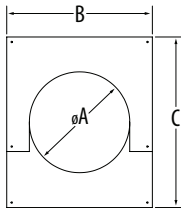

Use when penetrating walls or floor levels. Two piece design for easier installation.

SIZE	SPACER HZ				
	ORDER #	STOCK #	A	B	C
8"   200mm	8PPS-FSSDW	810010080	10 1/8"   253mm	14 5/8"   366mm	17 1/8"   428mm

### Firestop Support

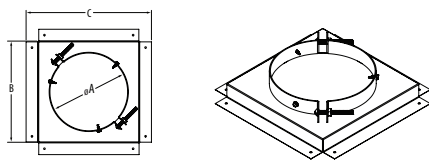

Use when penetrating floor levels with Double-Wall PolyPro and provide support at the ceiling level. Includes clamp that supports and prevents pipe sections from slipping down.

SIZE	SUP. ASSEMBLY				
	ORDER #	STOCK #	A	B	C
8"   200mm	8PPS-FSDW	810009922	10"   254mm	12"   305mm	14 1/8"   353mm

### Roof Support

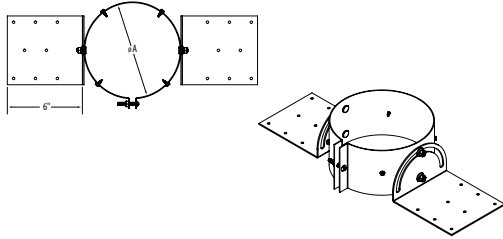

Used to support galvanized outer jacket and PolyPro vent within at the roof level. Adjustable to different roof pitches. Ideal for cathedral ceilings.

SIZE	ORDER #	STOCK #	A
8"   200mm	8PPS-RSDW	810010341	10"   254mm

### Horizontal Trim Plate

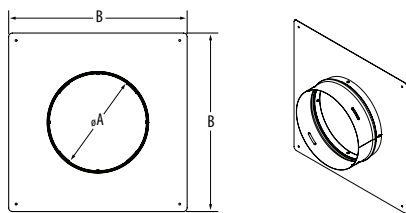

Used to trim interior wall penetration and transition from Double-Wall PolyPro (interior) to single wall pipe or Horizontal Termination (exterior). Includes built-in female twist-lock connection.

SIZE	ORDER #	STOCK #	A	B
8"   200mm	8PPS-HSTDW	810010077	10"   254mm	14"   358mm

### Vertical Termination

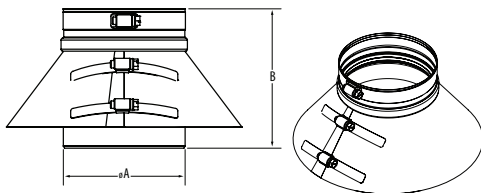

Use to vertically terminate a Double-Wall PolyPro system. Includes a AL29-4C stainless steel termination pipe with collar.

SIZE	ORDER #	STOCK #	A	B
8"   200mm	8PPS-VTDW	810009940	7 7/8"   200mm	7"   178mm

# PolyPro Flex Venting Components

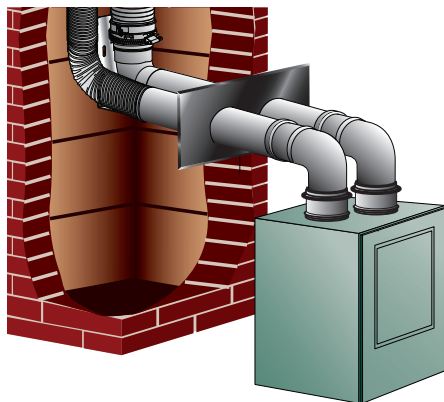

## Need An Air Intake Solution? Create Your Own Kit

Order DuraFlex AL length, Hanger Bracket, Coupler and Wall Plate for Twin Pipe. (2" Air intake will require a 2"-3" Increaser: 2PPS-X3)

- (1) DuraFlex AL Length: DFA-25, DFA-35, or DFA-50
- (1) Hanger Bracket: DFA-FCB
- (1) Coupler DFA-FCP
- (1) Wall Plate for Twin Pipe: PPS-WPT

## Flex Chimney Lining Kit



\*appliance adapter not included in the 5" Kit

Use for a vertical flex lining system. Includes black, UV resistant chimney cap, rigid flue vent, flex support bracket, 4 spacers in 3" & 4" kits, male and female flex adapters with gaskets, extended support elbow, wall plate, appliance adapter \*(not included in the 5" Kit), Locking Clamp, and Adapter Connector clamp. Flex sold separately.

SIZE	ORDER #	STOCK #
2"   60mm	2PPS-FKC	810014487
3"   80mm	3PPS-FKC	810014541
4"   100mm	4PPS-FKC	810014599
5"   130mm	5PPS-FKC	810014658

## Chimney Cap

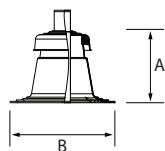

Use to vertically terminate a flex system. Black, UV resistant chimney cap with rigid steel flue vent.

SIZE	ORDER #	STOCK #	A	B
2"   60mm	2PPS-FCTC	810014486	9 3/4"   244mm	15 1/4"   381mm
3"   80mm	3PPS-FCTC	810014555	9 3/4"   244mm	15 1/4"   381mm
4"   100mm	4PPS-FCTC	810014617	9 3/4"   244mm	15 1/4"   381mm
5"   130mm	5PPS-FCTC	810014665	7 3/4"   197mm	15 3/4"   394mm

## Vertical Flex Termination Cap

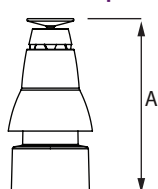

Use to vertically terminate a flex system when using the B-vent retrofit adapters. Includes male and female flex adapters and gaskets. Black, UV resistant. Match the termination size with flex diameter.

SIZE	ORDER #	STOCK #	A
2"   60mm	2PPS-VFTC	810009691	13 3/4"   349mm
3"   80mm	3PPS-VFTC	810014552	17"   432mm

### B-vent Retrofit Adapters

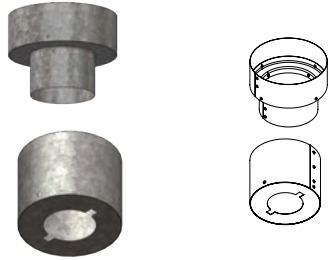

Use to retrofit common sizes of B-vent chimney for use as a chase for one appliance using PolyPro flex. Includes top cap adapter and bottom support cup. 3" size also includes required C-support plate.

SIZE	ORDER #	STOCK #
2"   60mm in a 3"   80mm chase	2PPS-BV3	810004332
2"   60mm in a 4"   100mm chase	2PPS-BV4	810004333
2"   60mm in a 5"   130mm chase	2PPS-BV5	810004334
3"   80mm in a 5"   130mm chase	3PPS-BV5	810004348
2"   60mm in a 6"   150mm chase	2PPS-BV6	810006999
3"   80mm in a 6"   150mm chase	3PPS-BV6	810005874

### Support Elbow



Use the support elbow to stabilize a vertical termination. Elbow has integrated support base that is compatible with bracket or support shown on the following page. Includes 1 Locking Clamp.

SIZE	ORDER #	STOCK #	SIZE	ORDER #	STOCK #
5"   130mm	5PPS-SE90C	810014659	8"   200mm	8PPS-SE90C	810014809
6"   150mm	6PPS-SE90C	810014692			

### Support Elbow Extended

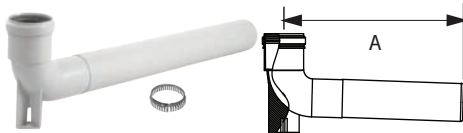

Use the extended support elbow to stabilize the vertical termination. Extended horizontal length can be trimmed to length as required. Elbow has integrated support base that is compatible with Support Bracket or Chimney Support shown. Includes 1 Locking Clamp.

SIZE	ORDER #	STOCK #	A
2"   60mm	2PPS-SE90XC	810014492	21 1/16"   551mm
3"   80mm	3PPS-SE90XC	810014548	22 1/4"   565mm
4"   100mm	4PPS-SE90XC	810014606	22 7/16"   570mm
5"   130mm	5PPS-SE90XC	810014660	24 7/16"   620mm

### Flex or Rigid Support Bracket



Use to secure the Support Elbow or the Extended Support Elbow inside a masonry chimney or chase. Heavy Duty.

SIZE	ORDER #	STOCK#
2"-8"   60mm - 200mm	PPS-SUP	810004225

### Flex Chimney Support



Use to support the Support Elbow inside a masonry chimney or chase. Includes mounting hardware and pipe support clamp.

SIZE	ORDER #	STOCK #	SIZE	ORDER #	STOCK #
2"   60mm	2PPS-SUP	810004338	4"   100mm	4PPS-SUP	810004364
3"   80mm	3PPS-SUP	810004352	5"   130mm	5PPS-SUP	810004375

### Flex Support Bracket

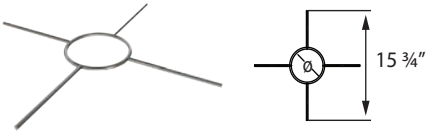

Use to support PolyPro Flex from top of masonry chimney or chase.

SIZE	ORDER #	STOCK #	SIZE	ORDER #	STOCK #
2"   60mm	2PPS-FSB	810004335	4"   100mm	4PPS-FSB	810004361
3"   80mm	3PPS-FSB	810004349	5"   130mm	5PPS-FSB	810004373

### Spacer



Use to center PolyPro flex. Universal for all diameters. Simple installation and ratchet adjustment. For 3" & 4" diameters, use 3PPS-S.

SIZE	ORDER #	STOCK #	SIZE	ORDER #	STOCK #
2"   60mm	2PPS-S	810004336	3"   80mm	3PPS-S	810004350

### Flex Length



Use to line masonry chimneys that vent condensing appliances. Double-wall construction. Can be cut to precise length in the field. Available in 25, 35 or 50 foot lengths. 5" diameter flex comes in rolls of 98 feet only.

SIZE	25 FEET		35 FEET	
	ORDER #	STOCK #	ORDER #	STOCK #
2"   60mm	2PPS-FLEX25	810004318	2PPS-FLEX35	810004319
3"   80mm	3PPS-FLEX25	810004321	3PPS-FLEX35	810004322
4"   100mm	4PPS-FLEX25	810004324	4PPS-FLEX35	810004325
SIZE	50 FEET		82 FEET	
	ORDER #	STOCK #	ORDER #	STOCK #
2"   60mm	2PPS-FLEX50	810004320	-	-
3"   80mm	3PPS-FLEX50	810004323	-	-
4"   100mm	-	-	4PPS-FLEX	810004326
SIZE	98 FEET			
	ORDER #	STOCK #		
5"   130mm	5PPS-FLEX	810004327		

### Flex Adapter Kit



Use with PolyPro flex lining system. Includes one male and one female adapter. These allow you to switch from rigid pipe to flex at the base of the system and back to rigid at the top. Flex gaskets (2) included.

SIZE	ORDER #	STOCK #	SIZE	ORDER #	STOCK #
3"   80mm	3PPS-FAS	810009373	5"   130mm	5PPS-FAS	810007033
4"   100mm	4PPS-FAS	810005987			

### Flex Male Adapter



Use to connect PolyPro rigid pipe to PolyPro flex at the base of the system. Flex gasket included.

SIZE	ORDER #	STOCK #	SIZE	ORDER #	STOCK #
2"   60mm	2PPS-FAM	810004329	4"   100mm	4PPS-FAM	810004358
3"   80mm	3PPS-FAM	810004344	5"   130mm	5PPS-FAM	810004370

### Flex Female Adapter



Use to convert from PolyPro flex back to PolyPro rigid pipe towards the top of the vent system. Flex gasket included.

SIZE	ORDER #	STOCK #	SIZE	ORDER #	STOCK #
2"   60mm	2PPS-FAF	810004330	4"   100mm	4PPS-FAF	810004359
3"   80mm	3PPS-FAF	810004345	5"   130mm	5PPS-FAF	810004371

### Flex Coupler Adapter



Use to tightly connect one length of PolyPro flex to another. Two flex gaskets are included.

SIZE	ORDER #	STOCK #	SIZE	ORDER #	STOCK #
2"   60mm	2PPS-FAC	810004331	4"   100mm	4PPS-FAC	810004360
3"   80mm	3PPS-FAC	810004346	5"   130mm	5PPS-FAC	810004372

### Wall Plate

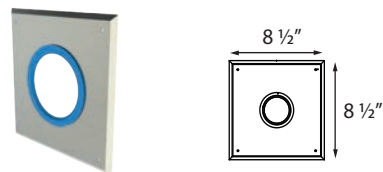

Use to trim wall penetration. Includes silicone seal for tight seal. Aluminum construction. White finish. Can be painted to suit.

SIZE	ORDER #	STOCK #	SIZE	ORDER #	STOCK #
2"   60mm	2PPS-WP	810004339	4"   100mm	4PPS-WP	810004365
3"   80mm	3PPS-WP	810004353	5"   130mm	5PPS-WP	810004376

### Viton Replacement Gasket Flex



Use as a replacement gasket for PolyPro flex products. Sold in packs of 12.

SIZE	ORDER #	STOCK #	SIZE	ORDER #	STOCK #
2"   60mm	2PPS-GAF	810004340	4"   100mm	4PPS-GAF	810004366
3"   80mm	3PPS-GAF	810004354	5"   130mm	5PPS-GAF	810004377

### Gaskets



Use as a replacement gasket for PolyPro Wall Plates. Sold in packs of 12

SIZE	ORDER #	STOCK #
2"   60mm	2PPS-GAW	810004423
3"   80mm	3PPS-GAW	810004424
4"   100mm	4PPS-GAW	810004425

## Flex Puller



Use with the provided rope to guide PolyPro flex lengths down masonry chimney. 2" version snaps onto flex, 3"-5" version twist-locks onto the male flex adapter.

SIZE	ORDER #	STOCK #	SIZE	ORDER #	STOCK #
2"   60mm	2PPS-FP	810004342	4"   100mm	4PPS-FP	810004368
3"   80mm	3PPS-FP	810004356	5"   130mm	5PPS-FP	810004378

## PolyPro Multi-Flex Venting System

## Reline Upper Plate

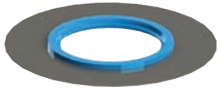

Use to seal pipe penetration with gasket, plate needs to be silicone sealed and fastened to (field fabricated) support plate.

SIZE	ORDER #	STOCK #	SIZE	ORDER #	STOCK #
2"   60mm	2PPS-RPU	810007982	4"   100mm	4PPS-RPU	810007963
3"   80mm	3PPS-RPU	810007983			

## Reline Hanger Support

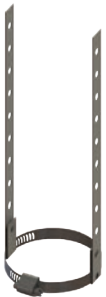

Use to support flex under the support plate. Clamps around the flex and is fastened to the support plate, then covered by the reline upper plate at the correct size. Universal for 2" - 4" diameters.

SIZE	ORDER #	STOCK #
2" - 4"   60mm - 100mm	PPS-RH	810007965

## Terms & Condition of Sale

1. **PRICES:** All prices and designs are subject to change without notice.
2. **CREDIT:** All sales are subject to credit approval.
3. **SALES TAX:** All sales are taxable unless buyer provides valid resale documentation prior to shipment. Buyer is responsible for all sales and use taxes.
4. **BROKEN CARTON CHARGES:** Broken carton orders are subject to broken carton charges. Broken carton charges are 25% of list price per stock #.
5. **PALLET CHARGES:** All palletized, stretch-wrapped orders are an additional \$5 per pallet.
6. **UPS:** All UPS orders are subject to \$10 handling charge.
7. **TERMS:** Unless otherwise specified, our payment terms are: net 30, F.O.B. shipping point.
8. **LATE CHARGES:** Delinquent accounts are subject to 1 ½% per month finance charge.
9. **MULTIPLE SHIPMENTS:** Orders may be fulfilled in separate shipments. Each shipment will be accompanied by a separate invoice and each invoice carries its own terms of payment.
10. **ALL SALES ARE FINAL:** All sales are final and product cannot be returned for credit.
11. **DELAYS:** DuraVent is not responsible for delays caused by our freight providers.
12. **REFUSAL OF DELIVERY:** Refused shipments, without cause, will result in additional charges, including freight, restocking and recartoning.
13. **SHORTAGES:** All claims for shortages and damages must be made within 48 hours.
14. **DAMAGE:** All visible damage on delivery is to be noted on the Bill of Lading before signing for delivery with driver. If shipment was freight collect, please file damage claim directly with the carrier. If shipment was freight Prepaid, please contact DuraVent Customer Service 800-835-4429 as soon as possible for assistance with freight claim. Any evidence of damage to the carton is cause for immediate inspection of the goods. Damaged goods must be retained by the customer until credit is approved. All claims for damages must be accompanied by proof (e.g. digital photo) and is subject to approval by DuraVent.
15. **DEFECTS:** All claims for manufacturing defects must be accompanied by proof (e.g. digital photo) and is subject to approval by DuraVent.
16. **INDEMNITY:** DuraVent does not permit modifications to products or changes to installation instructions. Customers modifying products or installation procedures shall, regardless of specific instructions to the user, indemnify, defend, and hold harmless DuraVent for any and all claimed losses or damages occasioned in whole or in part by special order or modified products and procedures.
17. **RESALE OVER THE INTERNET:** Resale of product over the internet is subject to the terms of our "Internet Sales Policy" and warranty. A copy of this policy can be obtained from Customer Service at 1-800-835-4429.



## 10 Year Warranty

DuraVent, Inc. provides this warranty for PolyPro® for ten years. Subject to the limitations set forth below, DuraVent warrants that its products will be free from defects in material or manufacturing, if properly installed, maintained and used. DuraVent products are fully warranted if installed only by a professional installer. This Warranty is transferable from the original homeowner to the buyer of the home within the warranted ten years. This warranty does not cover normal wear and tear, smoke damage or damage caused by chimney fires, acts of God, or any product that was: (1) purchased other than from an authorized DuraVent dealer, retailer or distributor; (2) modified or altered; (3) improperly serviced, inspected or cleaned; or (4) subject to negligence or any use not in accordance with the installation instructions included with the product as determined by DuraVent.

Installation instructions are available online at [www.duravent.com](http://www.duravent.com) under Support/Literature and through our Customer Service Department 800-835-4429 or [customerservice@duravent.com](mailto:customerservice@duravent.com).

DuraVent provides the following warranties for PolyPro: One Hundred Percent (100%) MSRP 10 years from the date of purchase.

All warranty obligations of DuraVent shall be limited to repair or replacement of the defective product pursuant to the terms and conditions applicable to each product line. These remedies shall constitute DuraVent's sole obligation and sole remedy under this warranty. This warranty provides no cash surrender value. The terms and conditions of this warranty may not be modified, altered or waived by any action, inaction or representation, whether oral or in writing, except upon the express, written authority of an executive officer of DuraVent.

This product is intended for venting only category II & IV appliances burning Natural Gas, Propane and Oil. All other fuels are not covered under this warranty.

**LIMITATIONS ON POLYPRO INTERNET SALES:** Notwithstanding any other terms or conditions of this PolyPro Warranty, DuraVent provides no warranty for PolyPro® if it is not installed by a qualified professional installer.

DuraVent must be notified and given the opportunity to inspect defective product prior to replacement under the terms of this limited lifetime warranty. All warranty claims must be submitted with proof of purchase. Labor and installation costs are not covered under this warranty. To obtain warranty service contact: DuraVent Warranty Service, 877 Cotting Ct., Vacaville CA 95688, or call 800-835-4429.

WHERE LAWFUL, DURAVENT DISCLAIMS ALL OTHER WARRANTIES, INCLUDING BUT NOT LIMITED TO IMPLIED WARRANTIES OF MERCHANTABILITY AND FITNESS FOR A PARTICULAR PURPOSE. IN NO EVENT WILL DURAVENT BE LIABLE FOR INCIDENTAL, CONSEQUENTIAL, PUNITIVE OR SPECIAL DAMAGES OR DIRECT OR INDIRECT LOSS OF ANY KIND, INCLUDING BUT NOT LIMITED TO PROPERTY DAMAGE AND PERSONAL INJURY. DURAVENT'S ENTIRE LIABILITY IS LIMITED TO THE PURCHASE PRICE OF THIS PRODUCT. SOME STATES DO NOT ALLOW LIMITATIONS ON IMPLIED WARRANTIES, OR THE EXCLUSION OR LIMITATION OF INCIDENTAL OR CONSEQUENTIAL DAMAGES, SO THE ABOVE LIMITATIONS AND EXCLUSIONS MAY NOT APPLY TO YOU. THIS LIMITED WARRANTY GIVES YOU SPECIFIC LEGAL RIGHTS, AND YOU MAY ALSO HAVE OTHER RIGHTS THAT VARY FROM STATE TO STATE.

For the most up-to-date installation instructions, see [www.duravent.com](http://www.duravent.com)

REV 11.28.17

DuraVent, Inc. Vacaville CA 95688







**DuraVent**<sup>®</sup>

[www.duravent.com](http://www.duravent.com) | 800-835-4429



L275\_Catalog\_PolyPro\_11-16-2021