



Flexible stainless steel relining
for masonry chimney.
UL 1777 and ULC S635.

DuraFlex®

DuraVent®

Leaders in-Venting Innovation™

Specifications

DuraFlex Pro

Applications

DuraFlex Pro ultra flexible relining for masonry chimney. Use with gas, wood pellet, oil, or wood appliances. Applications include: fireplace inserts, furnaces, boilers, and water heaters.

Materials and Construction

Single-wall .005" 316 stainless steel.

Clearances

0" clearance for gas, oil, and pellet applications. 1" clearance to masonry for wood-burning applications. Insulation is required for 0" clearance to masonry for wood-burning.

Diameters

3"-12".

Listings

Listed to UL 1777 and ULC S635 (MH45609).

DuraFlex SW

Applications

DuraFlex SW smooth wall flexible relining for masonry chimney. Use with gas, wood pellet, oil, or wood appliances. Applications include: fireplace inserts, furnaces, boilers, and water heaters.

Materials and Construction

Single-wall .005" overlapped 316 stainless steel (totalling .010"). Overlapped to create smooth inner wall.

Clearances

0" clearance for gas, oil, and pellet applications. 1" clearance to masonry for wood-burning applications. Insulation is required for 0" clearance to masonry for wood-burning.

Diameters

3"-12".

Listings

Listed to UL 1777 (MH45609).

UL 1777 and ULC S635 Systems

DuraFlex Pro

DuraFlex Pro is the ultimate in flexible steel liners for strength and flexibility. It features 20% more stainless steel per foot compared to other liners on the market. Its extreme flexibility facilitates problem free installations where multiple offsets are needed. DuraFlex Pro is available in 3" through 12" diameters in lengths, kits and custom lengths. DuraFlex Pro is manufactured utilizing highly corrosion resistant 316 Stainless Steel. Listed to UL 1777 and ULC S635.

DuraFlex SW

DuraFlex SW is a smooth inner-wall, flexible stainless steel chimney liner. The smooth inner wall provides for no output reduction allowing for full appliance efficiency. Smooth wall construction eliminates ridges that restrict flue gas flow and collect deposits. The lack of ridges facilitates cleaning and maintenance. DuraFlex SW is ideal for relining masonry chimney for wood and gas burning appliances. Listed to UL 1777.

Customize The Flex You Need.

All DuraFlex is available for orders requiring custom lengths (minimum 10' length). DuraFlex Pro and DuraFlex SW also offer 9"-12" diameters when ordered in custom lengths. (minimum 10' length). Use Ventinox components for all 9"-12" flex systems.



UL 1777 and ULC S635 Systems

DuraFlex 316 & 304

DuraFlex 304 and 316 are lighter, more economical liners. Excellent when there are minimal offsets in the chimney. DuraFlex 304SS and 316SS are intended for wood burning, non-condensing gas and oil fired appliances. Where greater corrosion resistance is desired, such as coal-fired appliances, DuraFlex 316 is recommended. DuraFlex 304SS and 316SS are listed to UL 1777 and ULC S635.

Insulation for Flex

All DuraFlex products must be insulated to meet UL 1777 requirements. See the end of the DuraFlex SS for the insulation section to find information on our offering: TherMix, ProFoil, AluFoil Tape, and ProMesh.

A Flexible Solution For Any Installation.

Having a choice when making a decision is important. DuraVent offers the installer a range of products to make the right decision for the right situation. There are four different DuraFlex liners, and a complete selection of DuraFlex universal components. No matter which flex is right for the situation, there's a DuraVent component to complete the venting system.



Specifications

DuraFlex 316 & 304

Applications

DuraFlex 316 flexible relining for masonry chimney. Use with gas, wood pellet, oil, or wood appliance. Applications include: fireplace inserts, furnaces, boilers, and water heaters. 316 is designed for use in harsher conditions, for more resistance to corrosion, such as coal.

DuraFlex 304 flexible relining for masonry chimney. Use with gas, wood pellet, oil, or wood appliances. Applications include: fireplace inserts, furnaces, boilers, and water heaters.

Materials and Construction

Single-wall .005" 316 or 304 stainless steel.

Clearances

0" clearance for gas, oil, and pellet applications. 1" clearance to masonry for wood-burning applications. Insulation is required for 0" clearance to masonry for wood-burning.

Diameters

3"-8".

Listings

Listed to UL 1777 and ULC S635 (MH45609).

Typical Installations

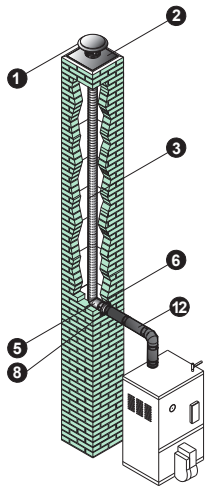

Oil Furnace
DuraFlex SS

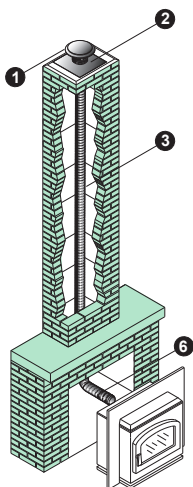

Pellet Insert
DuraFlex SS

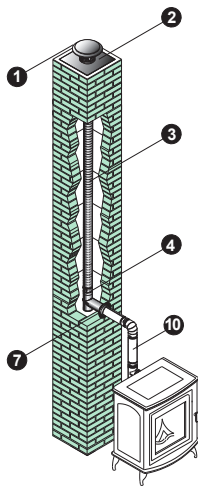

Pellet Stove
DuraFlex SS & PelletVent Pro

Installation Key

1	DuraFlex SS Removable Vertical Cap	8	DuraBlack Trim Collar
2	DuraFlex Top Plate w/welded Storm Collar	9	Rigid Type B Gas Vent
3	DuraFlex (SW, Pro, 304, 316) Length	10	Rigid PelletVent (L Vent)
4	DuraFlex SS Tee	11	ProFoil Insulation, AluFoil Tape & ProMesh
5	DuraFlex Mortar Sleeve	12	DVL or DuraBlack Pipe
6	DuraFlex SS Connector	13	Pipe Collar (B-Vent)
7	PelletVent Pro Appliance Adapter		

Refer to our Typical Venting Installation drawings to select the appropriate component parts for your installation.

- The inner pipe diameter should match the outlet size of the appliance.
- Check the appliance manufacturer's installation instructions to confirm which types of vent configurations are permitted (i.e. horizontal, vertical, chimney reline, etc.). Also, check for any venting restrictions such as maximum horizontal run, minimum and maximum vertical rise, maximum offset, etc.
- Be fire safe! Use proper support and bracing. Follow local building codes and have your venting system inspected.

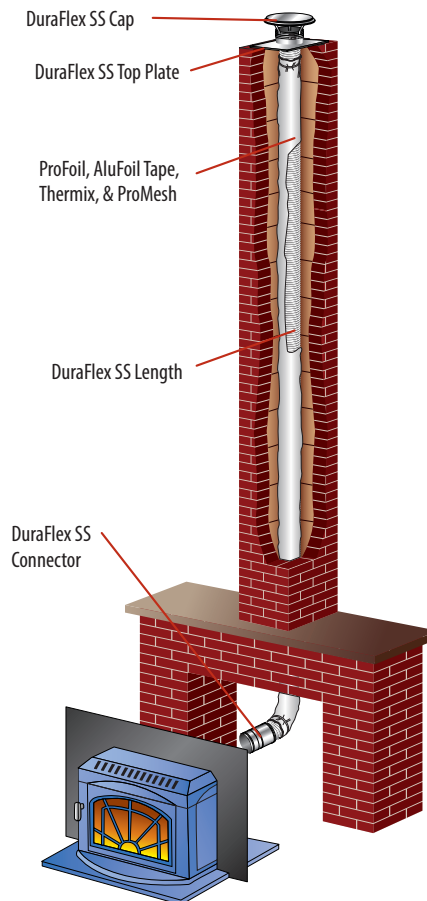

Planning Your Installation

1	Verify the venting requirements of the appliance used. Choose the liner system appropriate for the appliance and installation.
2	Refer to the Typical Installations for the type of liner installation similar to your situation. Identify the needed parts for installation.
3	The size of the liner should match the outlet size on the appliance or the size of the vent/manifold that penetrates into the masonry chimney.
4	Determine the length of liner needed.
5	Make sure of a proper fit for the Top Plate of the reliner to provide a secure, leak-proof installation.
6	If a free-standing appliance is used, select the vent or stovepipe pieces to connect from the appliance to the liner (refer to the appropriate section of catalog).
7	Important! Check to be sure the installation complies with all local and national code requirements, including clearance to combustibles. Contact the local building inspector for permit requirements.

Design Recommendations

- The following design recommendations are intended only as a general guideline to assist in the design and selection of liner components for your installation. Always read and follow DuraVent Installation instructions (enclosed with the cap or support box) before installing DuraFlex. Installation instructions can be viewed online at www.duravent.com, under catalogs and instructions.
- Before relining a chimney, it should be cleaned and inspected to verify the integrity of the mortar and masonry. In addition, have a certified chimney professional determine if the masonry was constructed with 0" or 1" clearance to the surrounding combustibles. This is an important fire safety issue that may have an influence on how the liner is installed.
- Be sure to select the proper liner for the application. DuraFlex SS is used for appliances that use oil, wood, or wood-pellets for fuel; DuraFlex AL is for a non-condensing gas appliance. Refer to the appliance manufacturer for installation requirements affecting venting. Keep the vent path as straight as possible for best performance.

Factory-Built Reline Kit

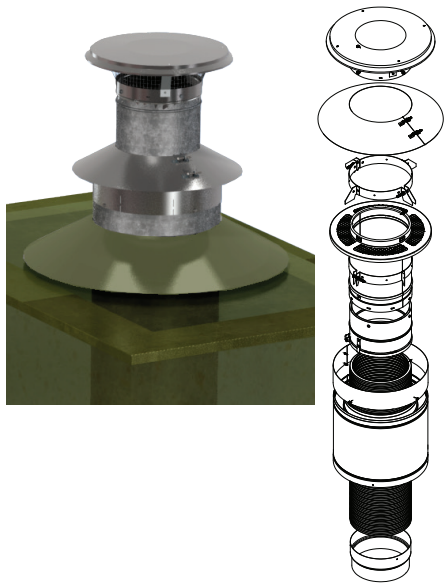

Use as a relining system for factory-built chimneys to be used with solid-fuel appliances in the USA. Relining is critical for performance and safety when a wood-burning insert is installed into an existing UL-127-listed fireplace.

Kit includes: Cap, Storm Collar, Support Bracket, Ventilation Disk, Centering Bracket, DuraLiner 12" Length, Flex Connector, Flex Length (25' or 35'), Adjustable Band, and Flex Adapter.

Minimum 8" chimney inner, maximum 14" outer.

SIZE	25' FLEX		35' FLEX		
	ORDER #	STOCK #	ORDER #	STOCK #	
6"	DuraFlex Pro	6DFPRO-25KFB	810007149	6DFPRO-35KFB	810007150
	DuraFlex 304	6DF304-25KFB	810007151	6DF304-35KFB	810007152
	DuraFlex 316	6DF316-25KFB	810007153	6DF316-35KFB	810007154

DuraFlex SW Basic Kit



Kit includes: DuraFlex SS Top Plate w/welded Storm Collar, DuraFlex SS Removable Vertical Cap, DuraFlex SS Connector, and DuraFlex SW length. Flex lengths available in 15', 20', 25', 30', and 35'.

SIZE	15' FLEX		20' FLEX		25' FLEX	
	ORDER #	STOCK #	ORDER #	STOCK #	ORDER #	STOCK #
3"	3DFSW-15K	810002293	3DFSW-20K	810002294	3DFSW-25K	810002295
4"	4DFSW-15K	810002298	4DFSW-20K	810002299	4DFSW-25K	810002300
5"	5DFSW-15K	810002303	5DFSW-20K	810002304	5DFSW-25K	810002305
5 1/2"	55DFSW-15K	810002308	55DFSW-20K	810002309	55DFSW-25K	810002310
6"	6DFSW-15K	810002313	6DFSW-20K	810002314	6DFSW-25K	810002315
7"	7DFSW-15K	810002318	7DFSW-20K	810002319	7DFSW-25K	810002320
8"	8DFSW-15K	810002323	8DFSW-20K	810002324	8DFSW-25K	810002325
SIZE	30' FLEX		35' FLEX			
	ORDER #	STOCK #	ORDER #	STOCK #		
3"	3DFSW-30K	810002296	3DFSW-35K	810002297		
4"	4DFSW-30K	810002301	4DFSW-35K	810002302		
5"	5DFSW-30K	810002306	5DFSW-35K	810002307		
5 1/2"	55DFSW-30K	810002311	55DFSW-35K	810002312		
6"	6DFSW-30K	810002316	6DFSW-35K	810002317		
7"	7DFSW-30K	810002321	7DFSW-35K	810002322		
8"	8DFSW-30K	810002326	8DFSW-35K	810002327		

DuraFlex SW Tee Kit



Kit includes: DuraFlex SS Top Plate w/welded Storm Collar, DuraFlex SS Removable Vertical Cap, DuraFlex SS Tee with Cap, and DuraFlex SW length. Kit flex lengths available in 15', 20', 25', 30', and 35'.

SIZE	15' FLEX		20' FLEX		25' FLEX	
	ORDER #	STOCK #	ORDER #	STOCK #	ORDER #	STOCK #
3"	3DFSW-15KT	810002328	3DFSW-20KT	810002329	3DFSW-25KT	810002330
4"	4DFSW-15KT	810002333	4DFSW-20KT	810002334	4DFSW-25KT	810002335
5"	5DFSW-15KT	810002338	5DFSW-20KT	810002339	5DFSW-25KT	810002340
5 1/2"	55DFSW-15KT	810002343	55DFSW-20KT	810002344	55DFSW-25KT	810002345
6"	6DFSW-15KT	810002348	6DFSW-20KT	810002349	6DFSW-25KT	810002350
7"	7DFSW-15KT	810002353	7DFSW-20KT	810002354	7DFSW-25KT	810002355
8"	8DFSW-15KT	810002358	8DFSW-20KT	810002359	8DFSW-25KT	810002360
SIZE	30' FLEX		35' FLEX			
	ORDER #	STOCK #	ORDER #	STOCK #		
3"	3DFSW-30KT	810002331	3DFSW-35KT	810002332		
4"	4DFSW-30KT	810002336	4DFSW-35KT	810002337		
5"	5DFSW-30KT	810002341	5DFSW-35KT	810002342		
5 1/2"	55DFSW-30KT	810002346	55DFSW-35KT	810002347		
6"	6DFSW-30KT	810002351	6DFSW-35KT	810002352		
7"	7DFSW-30KT	810002356	7DFSW-35KT	810002357		
8"	8DFSW-30KT	810002361	8DFSW-35KT	810002362		

DuraFlex SW Stainless Steel Length



Custom lengths also available for 3" - 8" diameters. 9"-12" diameters available in custom lengths only (Use Ventinox components). Minimum length of 10' for custom orders. Maximum 200' for 3" - 4" diameters, 125' for 5" diameter, 100' for 5.5" - 6", 50' for 7" - 8", 25' for 10" and 12" diameters. Must be ordered in increments of 10'.

3"-8" diameter flex can be ovalized up to the first 4'. Call Customer Service to add ovalizing to your order and for pricing.

SIZE	15' FLEX		20' FLEX		25' FLEX	
	ORDER #	STOCK #	ORDER #	STOCK #	ORDER #	STOCK #
3"	3DFSW-15	810002374	3DFSW-20	810002375	3DFSW-25	810002376
4"	4DFSW-15	810002381	4DFSW-20	810002382	4DFSW-25	810002383
5"	5DFSW-15	810002388	5DFSW-20	810002389	5DFSW-25	810002390
5 1/2"	55DFSW-15	810002395	55DFSW-20	810002396	55DFSW-25	810002397
6"	6DFSW-15	810002402	6DFSW-20	810002403	6DFSW-25	810002404
7"	7DFSW-15	810002409	7DFSW-20	810002410	7DFSW-25	810002411
8"	8DFSW-15	810002415	8DFSW-20	810002416	8DFSW-25	810002417
SIZE	30' FLEX		35' FLEX		50' FLEX	
	ORDER #	STOCK #	ORDER #	STOCK #	ORDER #	STOCK #
3"	3DFSW-30	810002377	3DFSW-35	810002378	3DFSW-50	810002379
4"	4DFSW-30	810002384	4DFSW-35	810002385	4DFSW-50	810002386
5"	5DFSW-30	810002391	5DFSW-35	810002392	5DFSW-50	810002393
5 1/2"	55DFSW-30	810002398	55DFSW-35	810002399	55DFSW-50	810002400
6"	6DFSW-30	810002405	6DFSW-35	810002406	6DFSW-50	810002407
7"	7DFSW-30	810002412	7DFSW-35	810002413	7DFSW-50	810002414
8"	8DFSW-30	810002418	8DFSW-35	810002419	8DFSW-50	810002420
SIZE	100' FLEX		125' FLEX		200' FLEX	
	ORDER #	STOCK #	ORDER #	STOCK #	ORDER #	STOCK #
3"	--	--	--	--	3DFSW-200	810002380
4"	--	--	--	--	4DFSW-200	810002387
5"	--	--	5DFSW-125	810002394	--	--
5 1/2"	55DFSW-100	810002401	--	--	--	--
6"	6DFSW-100	810002408	--	--	--	--

DuraFlex Pro Basic Kit



Kit includes: DuraFlex SS Top Plate w/welded Storm Collar, DuraFlex SS Removable Vertical Cap, DuraFlex SS Connector, and DuraFlex Pro length. Kit flex lengths available in 15', 20', 25', 30', and 35'.

SIZE	15' FLEX		20' FLEX		25' FLEX	
	ORDER #	STOCK #	ORDER #	STOCK #	ORDER #	STOCK #
3"	3DFPRO-15K	810002151	3DFPRO-20K	810002152	3DFPRO-25K	810002153
4"	4DFPRO-15K	810002156	4DFPRO-20K	810002157	4DFPRO-25K	810002158
5"	5DFPRO-15K	810002161	5DFPRO-20K	810002162	5DFPRO-25K	810002163
5 1/2"	55DFPRO-15K	810002166	55DFPRO-20K	810002167	55DFPRO-25K	810002168
6"	6DFPRO-15K	810002171	6DFPRO-20K	810002172	6DFPRO-25K	810002173
7"	7DFPRO-15K	810002176	7DFPRO-20K	810002177	7DFPRO-25K	810002178
8"	8DFPRO-15K	810002181	8DFPRO-20K	810002182	8DFPRO-25K	810002183
SIZE	30' FLEX		35' FLEX			
	ORDER #	STOCK #	ORDER #	STOCK #		
3"	3DFPRO-30K	810002154	3DFPRO-35K	810002155		
4"	4DFPRO-30K	810002159	4DFPRO-35K	810002160		
5"	5DFPRO-30K	810002164	5DFPRO-35K	810002165		
5 1/2"	55DFPRO-30K	810002169	55DFPRO-35K	810002170		
6"	6DFPRO-30K	810002174	6DFPRO-35K	810002175		
7"	7DFPRO-30K	810002179	7DFPRO-35K	810002180		
8"	8DFPRO-30K	810002184	8DFPRO-35K	810002185		

DuraFlex Pro Tee Kit



Kit includes: DuraFlex SS Top Plate w/welded Storm Collar, DuraFlex SS Removable Vertical Cap, DuraFlex SS Tee with Cap, and DuraFlex Pro length. Kit flex lengths available in 15', 20', 25', 30', and 35'.

SIZE	15' FLEX		20' FLEX		25' FLEX	
	ORDER #	STOCK #	ORDER #	STOCK #	ORDER #	STOCK #
3"	3DFPRO-15KT	810002186	3DFPRO-20KT	810002187	3DFPRO-25KT	810002188
4"	4DFPRO-15KT	810002191	4DFPRO-20KT	810002192	4DFPRO-25KT	810002193
5"	5DFPRO-15KT	810002196	5DFPRO-20KT	810002197	5DFPRO-25KT	810002198
5 1/2"	55DFPRO-15KT	810002201	55DFPRO-20KT	810002202	55DFPRO-25KT	810002203
6"	6DFPRO-15KT	810002206	6DFPRO-20KT	810002207	6DFPRO-25KT	810002208
7"	7DFPRO-15KT	810002211	7DFPRO-20KT	810002212	7DFPRO-25KT	810002213
8"	8DFPRO-15KT	810002216	8DFPRO-20KT	810002217	8DFPRO-25KT	810002218
SIZE	30' FLEX		35' FLEX			
	ORDER #	STOCK #	ORDER #	STOCK #		
3"	3DFPRO-30KT	810002189	3DFPRO-35KT	810002190		
4"	4DFPRO-30KT	810002194	4DFPRO-35KT	810002195		
5"	5DFPRO-30KT	810002199	5DFPRO-35KT	810002200		
5 1/2"	55DFPRO-30KT	810002204	55DFPRO-35KT	810002205		
6"	6DFPRO-30KT	810002209	6DFPRO-35KT	810002210		
7"	7DFPRO-30KT	810002214	7DFPRO-35KT	810002215		
8"	8DFPRO-30KT	810002219	8DFPRO-35KT	810002220		

DuraFlex Pro Top Plate/Cap Kit



Kit includes: DuraFlex SS Top Plate w/welded Storm Collar, DuraFlex SS Removable Vertical Cap, plus DuraFlex SS Connector, and DuraFlex Pro length. Flex remains secured to the Storm Collar/Top Plate when removing the cap section for inspections and cleaning.

SIZE	20' FLEX		25' FLEX	
	ORDER #	STOCK #	ORDER #	STOCK #
3"	3DFPRO-20VCK	810002221	3DFPRO-25VCK	810006967
4"	4DFPRO-20VCK	810002222	4DFPRO-25VCK	810002223
5"	--	--	5DFPRO-25VCK	810006969
5 1/2"	55DFPRO-20VCK	810002226	55DFPRO-25VCK	810002227
6"	--	--	6DFPRO-25VCK	810002230
7"	--	--	7DFPRO-25VCK	810006971
8"	--	--	8DFPRO-25VCK	810006973
SIZE	30' FLEX		35' FLEX	
	ORDER #	STOCK #	ORDER #	STOCK #
3"	--	--	3DFPRO-35VCK	810006968
4"	4DFPRO-30VCK	810002224	4DFPRO-35VCK	810002225
5"	--	--	5DFPRO-35VCK	810006970
5 1/2"	55DFPRO-30VCK	810002228	55DFPRO-35VCK	810002229
6"	6DFPRO-30VCK	810002231	6DFPRO-35VCK	810002232
7"	--	--	7DFPRO-35VCK	810006972
8"	--	--	8DFPRO-35VCK	810006974

DuraFlex Pro Ovalized Top Plate/Cap Kit



Kit includes: DuraFlex SS Top Plate w/welded Storm Collar, DuraFlex SS Removable Vertical Cap, Oval to Round Insert Adapter with Clamp, and DuraFlex Pro length with the first 4 feet ovalized. Flex remains secured to the Storm Collar/Top Plate when removing the cap section for inspections and cleaning.

SIZE	25' FLEX		35' FLEX	
	ORDER #	STOCK #	ORDER #	STOCK #
6"	6DFPRO-25OVALVCK	810002233	6DFPRO-35OVALVCK	810002234

DuraFlex Pro Stainless Steel Length



Custom lengths also available for 3" - 8" diameters. 9"-12" diameters available in custom lengths only (Use Ventinox components). Minimum length of 10' for custom orders. Maximum 200' for 3" - 4" diameters, 125' for 5" diameter, 100' for 5.5" - 6", 50' for 7" - 8", 25' for 10" and 12" diameters. Must be ordered in increments of 10'.

3"-8" diameter flex can be ovalized up to the first 4'. Call Customer Service to add ovalizing to your order and for pricing.

SIZE	15' FLEX		20' FLEX		25' FLEX	
	ORDER #	STOCK #	ORDER #	STOCK #	ORDER #	STOCK #
3"	3DFPRO-15	810002246	3DFPRO-20	810002247	3DFPRO-25	810002248
4"	4DFPRO-15	810002253	4DFPRO-20	810002254	4DFPRO-25	810002255
5"	5DFPRO-15	810002260	5DFPRO-20	810002261	5DFPRO-25	810002262
5 1/2"	55DFPRO-15	810002267	55DFPRO-20	810002268	55DFPRO-25	810002269
6"	6DFPRO-15	810002274	6DFPRO-20	810002275	6DFPRO-25	810006161
7"	7DFPRO-15	810002281	7DFPRO-20	810002282	7DFPRO-25	810002283
8"	8DFPRO-15	810002287	8DFPRO-20	810002288	8DFPRO-25	810002289
SIZE	30' FLEX		35' FLEX		50' FLEX	
	ORDER #	STOCK #	ORDER #	STOCK #	ORDER #	STOCK #
3"	3DFPRO-30	810002249	3DFPRO-35	810002250	3DFPRO-50	810002251
4"	4DFPRO-30	810002256	4DFPRO-35	810002257	4DFPRO-50	810002258
5"	5DFPRO-30	810002263	5DFPRO-35	810002264	5DFPRO-50	810002265
5 1/2"	55DFPRO-30	810002270	55DFPRO-35	810002271	55DFPRO-50	810002272
6"	6DFPRO-30	810002277	6DFPRO-35	810002278	6DFPRO-50	810006164
7"	7DFPRO-30	810002284	7DFPRO-35	810002285	7DFPRO-50	810002286
8"	8DFPRO-30	810002290	8DFPRO-35	810002291	8DFPRO-50	810002292
SIZE	100' FLEX		125' FLEX		200' FLEX	
	ORDER #	STOCK #	ORDER #	STOCK #	ORDER #	STOCK #
3"	--	--	--	--	3DFPRO-200	810002252
4"	--	--	--	--	4DFPRO-200	810002259
5"	--	--	5DFPRO-125	810002266	--	--
5 1/2"	55DFPRO-100	810002273	--	--	--	--
6"	6DFPRO-100	810002280	--	--	--	--

DuraFlex 316 Basic Kit



Kit includes: DuraFlex SS Top Plate w/welded Storm Collar, DuraFlex SS Removable Vertical Cap, DuraFlex SS Connector, and DuraFlex 316 length. Kit flex lengths available in 15', 20', 25', 30', and 35'.

SIZE	15' FLEX		20' FLEX		25' FLEX	
	ORDER #	STOCK #	ORDER #	STOCK #	ORDER #	STOCK #
3"	3DF316-15K	810002026	3DF316-20K	810002027	3DF316-25K	810002028
4"	4DF316-15K	810002031	4DF316-20K	810002032	4DF316-25K	810002033
5"	5DF316-15K	810002036	5DF316-20K	810002037	5DF316-25K	810002038
5 1/2"	55DF316-15K	810002041	55DF316-20K	810002042	55DF316-25K	810002043
6"	6DF316-15K	810002046	6DF316-20K	810002047	6DF316-25K	810002048
7"	7DF316-15K	810002051	7DF316-20K	810002052	7DF316-25K	810002053
8"	8DF316-15K	810002056	8DF316-20K	810002057	8DF316-25K	810002058
SIZE	30' FLEX		35' FLEX			
	ORDER #	STOCK #	ORDER #	STOCK #		
3"	3DF316-30K	810002029	3DF316-35K	810002030		
4"	4DF316-30K	810002034	4DF316-35K	810002035		
5"	5DF316-30K	810002039	5DF316-35K	810002040		
5 1/2"	55DF316-30K	810002044	55DF316-35K	810002045		
6"	6DF316-30K	810002049	6DF316-35K	810002050		
7"	7DF316-30K	810002054	7DF316-35K	810002055		
8"	8DF316-30K	810002059	8DF316-35K	810002060		

DuraFlex 316 Tee Kit



Kit includes: DuraFlex SS Top Plate w/welded Storm Collar, DuraFlex SS Removable Vertical Cap, DuraFlex SS Tee with Cap, and DuraFlex 316 length. Kit flex lengths available in 15', 20', 25', 30', and 35'.

SIZE	15' FLEX		20' FLEX		25' FLEX	
	ORDER #	STOCK #	ORDER #	STOCK #	ORDER #	STOCK #
3"	3DF316-15KT	810002061	3DF316-20KT	810002062	3DF316-25KT	810002063
4"	4DF316-15KT	810002066	4DF316-20KT	810002067	4DF316-25KT	810002068
5"	5DF316-15KT	810002071	5DF316-20KT	810002072	5DF316-25KT	810002073
5 1/2"	55DF316-15KT	810002076	55DF316-20KT	810002077	55DF316-25KT	810002078
6"	6DF316-15KT	810002081	6DF316-20KT	810002082	6DF316-25KT	810002083
7"	7DF316-15KT	810002086	7DF316-20KT	810002087	7DF316-25KT	810002088
8"	8DF316-15KT	810002091	8DF316-20KT	810002092	8DF316-25KT	810002093
SIZE	30' FLEX		35' FLEX			
	ORDER #	STOCK #	ORDER #	STOCK #		
3"	3DF316-30KT	810002064	3DF316-35KT	810002065		
4"	4DF316-30KT	810002069	4DF316-35KT	810002070		
5"	5DF316-30KT	810002074	5DF316-35KT	810002075		
5 1/2"	55DF316-30KT	810002079	55DF316-35KT	810002080		
6"	6DF316-30KT	810002084	6DF316-35KT	810002085		
7"	7DF316-30KT	810002089	7DF316-35KT	810002090		
8"	8DF316-30KT	810002094	8DF316-35KT	810002095		

DuraFlex 316 Top Plate/Cap Kit



Kit includes: DuraFlex SS Top Plate w/welded Storm Collar, DuraFlex SS Removable Vertical Cap, plus DuraFlex SS Connector, and DuraFlex 316 length. Flex remains secured to the Storm Collar/Top Plate when removing the cap section for inspections and cleaning.

SIZE	25' FLEX		35' FLEX	
	ORDER #	STOCK #	ORDER #	STOCK #
4"	4DF316-25VCK	810002096	4DF316-35VCK	810002097
5 1/2"	55DF316-25VCK	810002098	55DF316-35VCK	810002099
6"	6DF316-25VCK	810002100	6DF316-35VCK	810002101

DuraFlex 316 Stainless Steel Length



Use with wood-pellet, non-condensing gas, wood-burning, and oil appliances. Custom lengths available for 3"-8" diameters. Minimum length of 10' for custom orders. Maximum 100' for 3" - 8". Must be ordered in increments of 10'.

3"-8" diameter flex can be ovalized up to the first 4'. Call Customer Service to add ovalizing to your order and for pricing.

SIZE	15' FLEX		20' FLEX		25' FLEX	
	ORDER #	STOCK #	ORDER #	STOCK #	ORDER #	STOCK #
3"	3DF316-15	810002109	3DF316-20	810002110	3DF316-25	810002111
4"	4DF316-15	810002115	4DF316-20	810002116	4DF316-25	810002117
5"	5DF316-15	810002121	5DF316-20	810002122	5DF316-25	810002123
5 1/2"	55DF316-15	810002127	55DF316-20	810002128	55DF316-25	810002129
6"	6DF316-15	810002133	6DF316-20	810002134	6DF316-25	810002135
7"	7DF316-15	810002139	7DF316-20	810002140	7DF316-25	810002141
8"	8DF316-15	810002145	8DF316-20	810002146	8DF316-25	810002147
SIZE	30' FLEX		35' FLEX		50' FLEX	
	ORDER #	STOCK #	ORDER #	STOCK #	ORDER #	STOCK #
3"	3DF316-30	810002112	3DF316-35	810002113	--	--
4"	4DF316-30	810002118	4DF316-35	810002119	--	--
5"	5DF316-30	810002124	5DF316-35	810002125	--	--
5 1/2"	55DF316-30	810002130	55DF316-35	810002131	--	--
6"	6DF316-30	810002136	6DF316-35	810002137	--	--
7"	7DF316-30	810002142	7DF316-35	810002143	7DF316-50	810002144
8"	8DF316-30	810002148	8DF316-35	810002149	8DF316-50	810002150
SIZE	100' FLEX					
	ORDER #	STOCK #				
3"	3DF316-100	810002114				
4"	4DF316-100	810002120				
5"	5DF316-100	810002126				
5 1/2"	55DF316-100	810002132				
6"	6DF316-100	810002138				

DuraFlex 304 Basic Kit



Kit includes: DuraFlex SS Top Plate w/welded Storm Collar, DuraFlex SS Removable Vertical Cap, DuraFlex SS Connector, and DuraFlex 304 length. Kit flex lengths available in 15', 20', 25', 30', and 35'.

SIZE	15' FLEX		20' FLEX		25' FLEX	
	ORDER #	STOCK #	ORDER #	STOCK #	ORDER #	STOCK #
3"	3DF304-15K	810001907	3DF304-20K	810001908	3DF304-25K	810001909
4"	4DF304-15K	810001912	4DF304-20K	810001913	4DF304-25K	810001914
5"	5DF304-15K	810001917	5DF304-20K	810001918	5DF304-25K	810001919
5 1/2"	55DF304-15K	810001922	55DF304-20K	810001923	55DF304-25K	810001924
6"	6DF304-15K	810001927	6DF304-20K	810001928	6DF304-25K	810001929
7"	7DF304-15K	810001932	7DF304-20K	810001933	7DF304-25K	810001934
8"	8DF304-15K	810001937	8DF304-20K	810001938	8DF304-25K	810001939
SIZE	30' FLEX		35' FLEX			
	ORDER #	STOCK #	ORDER #	STOCK #		
3"	3DF304-30K	810001910	3DF304-35K	810001911		
4"	4DF304-30K	810001915	4DF304-35K	810001916		
5"	5DF304-30K	810001920	5DF304-35K	810001921		
5 1/2"	55DF304-30K	810001925	55DF304-35K	810001926		
6"	6DF304-30K	810001930	6DF304-35K	810001931		
7"	7DF304-30K	810001935	7DF304-35K	810001936		
8"	8DF304-30K	810001940	8DF304-35K	810001941		

DuraFlex 304 Tee Kit

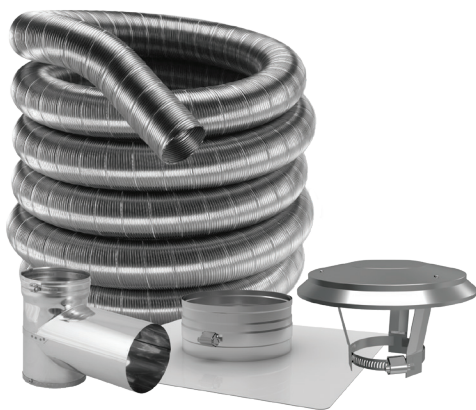

Kit includes: DuraFlex SS Top Plate w/welded Storm Collar, DuraFlex SS Removable Vertical Cap, DuraFlex SS Tee with Cap, and DuraFlex 304 length. Kit flex lengths available in 15', 20', 25', 30', and 35'.

SIZE	15' FLEX		20' FLEX		25' FLEX	
	ORDER #	STOCK #	ORDER #	STOCK #	ORDER #	STOCK #
3"	3DF304-15KT	810001942	3DF304-20KT	810001943	3DF304-25KT	810001944
4"	4DF304-15KT	810001947	4DF304-20KT	810001948	4DF304-25KT	810001949
5"	5DF304-15KT	810001952	5DF304-20KT	810001953	5DF304-25KT	810001954
5 1/2"	55DF304-15KT	810001957	55DF304-20KT	810001958	55DF304-25KT	810001959
6"	6DF304-15KT	810001962	6DF304-20KT	810001963	6DF304-25KT	810001964
7"	7DF304-15KT	810001967	7DF304-20KT	810001968	7DF304-25KT	810001969
8"	8DF304-15KT	810001972	8DF304-20KT	810001973	8DF304-25KT	810001974
SIZE	30' FLEX		35' FLEX			
	ORDER #	STOCK #	ORDER #	STOCK #		
3"	3DF304-30KT	810001945	3DF304-35KT	810001946		
4"	4DF304-30KT	810001950	4DF304-35KT	810001951		
5"	5DF304-30KT	810001955	5DF304-35KT	810001956		
5 1/2"	55DF304-30KT	810001960	55DF304-35KT	810001961		
6"	6DF304-30KT	810001965	6DF304-35KT	810001966		
7"	7DF304-30KT	810001970	7DF304-35KT	810001971		
8"	8DF304-30KT	810001975	8DF304-35KT	810001976		

DuraFlex 304 Stainless Steel Length



Use with wood-pellet, non-condensing gas, wood-burning, and oil appliances. Custom lengths available for 3"-8" diameters. Minimum length of 10' for custom orders. Maximum 100' for 3" - 8". Must be ordered in increments of 10'.

3"-8" diameter flex can be ovalized up to the first 4'. Call Customer Service to add ovalizing to your order and for pricing.

SIZE	15' FLEX		20' FLEX		25' FLEX	
	ORDER #	STOCK #	ORDER #	STOCK #	ORDER #	STOCK #
3"	3DF304-15	810001984	3DF304-20	810001985	3DF304-25	810001986
4"	4DF304-15	810001990	4DF304-20	810001991	4DF304-25	810001992
5"	5DF304-15	810001996	5DF304-20	810001997	5DF304-25	810001998
5 1/2"	55DF304-15	810002002	55DF304-20	810002003	55DF304-25	810002004
6"	6DF304-15	810002008	6DF304-20	810002009	6DF304-25	810002010
7"	7DF304-15	810002014	7DF304-20	810002015	7DF304-25	810002016
8"	8DF304-15	810002020	8DF304-20	810002021	8DF304-25	810002022
SIZE	30' FLEX		35' FLEX		50' FLEX	
	ORDER #	STOCK #	ORDER #	STOCK #	ORDER #	STOCK #
3"	3DF304-30	810001987	3DF304-35	810001988	--	--
4"	4DF304-30	810001993	4DF304-35	810001994	--	--
5"	5DF304-30	810001999	5DF304-35	810002000	--	--
5 1/2"	55DF304-30	810002005	55DF304-35	810002006	--	--
6"	6DF304-30	810002011	6DF304-35	810002012	--	--
7"	7DF304-30	810002017	7DF304-35	810002018	7DF304-50	810002019
8"	8DF304-30	810002023	8DF304-35	810002024	8DF304-50	810002025
SIZE	100' FLEX					
	ORDER #	STOCK #				
3"	3DF304-100	810001989				
4"	4DF304-100	810001995				
5"	5DF304-100	810002001				
5 1/2"	55DF304-100	810002007				
6"	6DF304-100	810002013				

Custom Flex & Custom Flex Kits

Custom Kits are part of the program. Combine the DuraFlex length of your choice with any of our DuraFlex accessories to create your own custom kit. Customize your flex length by ovalizing the first 4'.

Custom Flex Length Minimum order of 10 feet. 'XX' in stock number indicates feet.

Flex		3"	4"	5"	5 1/2"	6"	7"	8"	10"	12"
DuraFlex SW	ORDER #	3DFS-XX	4DFS-XX	5DFS-XX	55DFS-XX	6DFS-XX	7DFS-XX	8DFS-XX	10DFS-XX	12DFS-XX
	STOCK #	810005857	810005969	---	810006039	810006167	810006657	---	---	810005041
DuraFlex Pro	ORDER #	3DFPRO-XX	4DFPRO-XX	5DFPRO-XX	55DFPRO-XX	6DFPRO-XX	7DFPRO-XX	8DFPRO-XX	10DFPRO-XX	12DFPRO-XX
	STOCK #	810002235	810002236	810002237	810002238	810002239	810002240	810002241	810004941	810007047
DuraFlex 316	ORDER #	3DF316-XX	4DF316-XX	5DF316-XX	55DF316-XX	6DF316-XX	7DF316-XX	8DF316-XX	---	---
	STOCK #	80005853	810005961	810006059	---	810006157	---	---	---	---
DuraFlex 304	ORDER #	3DF304-XX	4DF304-XX	5DF304-XX	55DF304-XX	6DF304-XX	7DF304-XX	8DF304-XX	---	---
	STOCK #	---	810005959	810006057	810006035	810006154	---	810006683	---	---

Custom Ovalization of Flex

3"-8" diameter flex can be ovalized up to the first 4'. Call Customer Service to add ovalizing to your order and for pricing.

Custom Flex Accessories for your Kit

Accessories	3"	4"	5"	5 1/2"	6"	7"	8"	10"	12"
	ORDER #	ORDER #	ORDER #	ORDER #	ORDER #	ORDER #	ORDER #	ORDER #	ORDER #
Vertical Cap	---	---	---	---	---	---	---	10DFS-RCSC	12DFS-RCSC
Top Plate	---	---	---	---	---	---	---	10DFS-TP	12DFS-TP
Removable Vertical Cap	3DFS-VCRC	4DFS-VCRC	5DFS-VCRC	55DFS-VCRC	6DFS-VCRC	7DFS-VCRC	8DFS-VCRC	---	---
Top Plate Storm Collar	3DFS-TPSC	4 DFS-TPSC	5 DFS-TPSC	55 DFS-TPSC	6 DFS-TPSC	7 DFS-TPSC	8 DFS-TPSC	---	---
Vertical Cap Kit	3DFS-VCK	4DFS-VCK	5DFS-VCK	55DFS-VCK	6DFS-VCK	7DFS-VCK	8DFS-VCK	--	--
Tee	3DFS-T	4DFS-T	5DFS-T	55DFS-T	6DFS-T	7DFS-T	8DFS-T	--	--
Connector	3DFS-FC	4DFS-FC	5DFS-FC	55DFS-FC	6DFS-FC	7DFS-FC	8DFS-FC	10DFS-FC	12DFS-FC
Reducer	--	--	--	--	6DFS-X55	--	--	--	--
Spacer	--	--	5DFS-S	--	6DFS-S	7DFS-S	8DFS-S	--	--
Mortar Sleeve	3DFS-MS	4DFS-MS	5DFS-MS	55DFS-MS	6DFS-MS	7DFS-MS	8DFS-MS	--	--
Flex Puller	3DFS-FP	4DFS-FP	5DFS-FP	55DFS-FP	6DFS-FP	7DFS-FP	8DFS-FP	10DFS-FP	12DFS-FP
Spark Arrestor	DFS-SA	DFS-SA	DFS-SA	DFS-SA	DFS-SA	DFS-SA	DFS-SA	--	--
Tee w/ Removable Snout	--	--	--	--	--	--	--	10DFS-TRS	12DFS-TRS
Tee Cap	--	--	--	--	--	--	--	10DFS-TCV	12DFS-TCV
Long Tee Snout	--	--	--	--	--	--	--	10DFS-TLS	12DFS-TLS

Choose exactly the length of flex you need from 4 different choices...

Need smooth wall? An ultra flexible liner or maybe 304? No need to trouble yourself with cutting the length out in the field....we trim it exactly as you need it.

Ovalize the first 4 feet of the liner you purchase.

If you need the liner ovalized, be sure to let Customer Service know and the first 4' of the length will be ovalized.

Add exactly the parts you need in your kit.

Need a connector with a tee or cap? Customize your kit to get just what you need.



Vertical Cap Kit

Top Plate with welded Storm Collar, and cap. Flex remains secured to the Storm Collar/Top Plate when removing the cap section for inspections and cleaning.

DuraFlex Insert Adapter



Use to connect the flex to an insert that has a flat surfaced outlet.

SIZE	ORDER #	STOCK #
3"	3DFS-ADC	810008046
4"	4DFS-ADC	810008047
5"	5DFS-ADC	810008048
5 1/2"	55DFS-ADC	810008049
6"	6DFS-ADC	810008050
7"	7DFS-ADC	810008051
8"	8DFS-ADC	810008052

DuraFlex SS Connector



3" - 8"

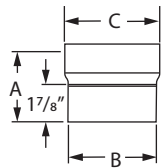

10" - 12"

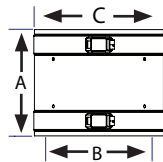

Use to connect DuraFlex SS length to an appliance, rigid length, or flex length. Drip-free connection.

SIZE	ORDER #	STOCK #	A	B	C
3"	3DFS-FC	810002424	4 1/8"	3"	3 1/2"
4"	4DFS-FC	810002432	4 1/8"	4"	4 1/2"
5"	5DFS-FC	810002441	4 1/8"	5"	5 1/2"
5 1/2"	55DFS-FC	810002451	4 1/8"	6"	5 1/2"
6"	6DFS-FC	810002460	4 1/8"	6 1/2"	6"
7"	7DFS-FC	810002469	4 1/8"	7"	7 1/2"
8"	8DFS-FC	810002477	4 1/8"	8"	8 1/2"
10"	10DFS-FC	810016907	4 1/2"	9 3/4"	10 3/8"
12"	12DFS-FC	810016909	4 1/2"	11 3/4"	12 3/8"

DuraFlex SS Reducer

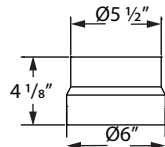

Use to connect 5 1/2" DuraFlex SS length to a 6" appliance. Check with the appliance manufacturer before reducing the vent size. May also be used to connect to stovepipe on a through masonry wall installations.

SIZE	ORDER #	STOCK #
5 1/2"	6DFS-X55	810002465

DuraFlex SS Reducer w/clamp

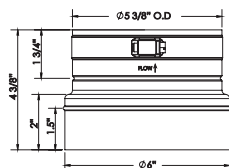

Use to connect 5 1/2" DuraFlex SS length to a 6" appliance. Check with the appliance manufacturer before reducing the vent size. May also be used to connect to stovepipe on a through masonry wall installations.

SIZE	ORDER #	STOCK #
5 1/2"	6DFS-X55WC	810006168
5"	6DFS-X5WC	810006169

DuraFlex SS Tee w/ Cap

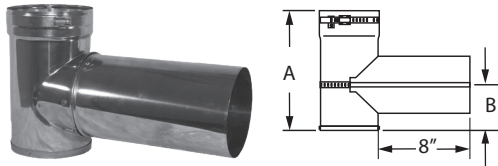

Use to attach to DuraFlex SS length with a fast connect band. Removable branch connects tee body with an internal fast connect band. 5 1/2" Tee has a 6" branch.

SIZE	ORDER #	STOCK #	A	B
3"	3DFS-T	810002423	8 1/2"	3 1/4"
4"	4DFS-T	810002431	9 1/2"	4 1/4"
5"	5DFS-T	810002440	9 1/2"	4 1/4"
5 1/2"	55DFS-T	810002450	10 1/2"	4 3/8"
6"	6DFS-T	810002459	10 1/2"	4 3/8"
7"	7DFS-T	810002468	11 1/2"	4 1/2"
8"	8DFS-T	810002476	13"	5 3/4"

Spacer

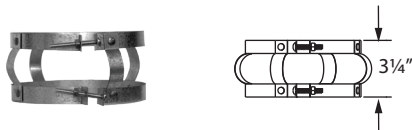

Use to maintain a 1" clearance with flex sections of DuraLiner and DuraFlex SS.

SIZE	ORDER #	STOCK #
5"	5DFS-S	810002442
6"	6DFS-S	810002461
7"	7DFS-S	810002470
8"	8DFS-S	810002478

DuraFlex SS Top Plate and Storm Collar

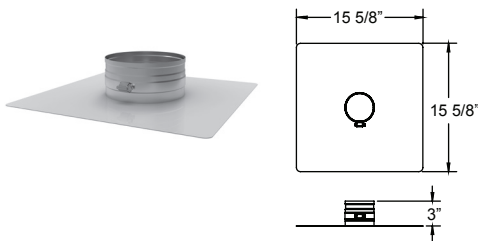

Used to seal top of masonry chimney and support flex. Flex is secured to storm collar with fast connect band.

SIZE	ORDER #	STOCK #
3"	3DFS-TPSC	810017704
4"	4DFS-TPSC	810017705
5"	5DFS-TPSC	810017706
5.5"	55DFS-TPSC	810017707
6"	6DFS-TPSC	810017708
7"	7DFS-TPSC	810017709
8"	8DFS-TPSC	810017710

DuraFlex SS Top Plate

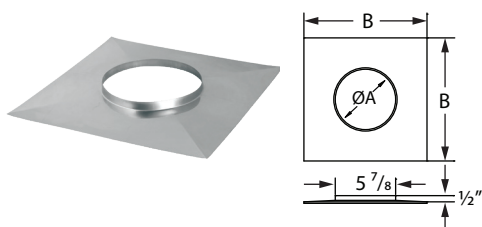

Use to seal top of masonry chimney and support the flex.

SIZE	ORDER #	STOCK #	A	B
10"	10DFS-TP	810016955	10 1/4"	18"
12"	12DFS-TP	810016957	12 1/4"	18"

DuraFlex SS Removable Vertical Cap

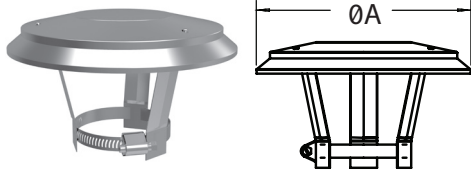

Use to terminate a relining system. Attach to storm collar with fast connect band. Optional spark arrestor available.

SIZE	ORDER #	STOCK #	A
3"	3DFS-VCRC	810017306	8"
4"	4DFS-VCRC	810017307	8"
5"	5DFS-VCRC	810017308	11"
5.5"	55DFS-VCRC	810017309	11"
6"	6DFS-VCRC	810017310	11"
7"	7DFS-VCRC	810017311	15"
8"	8DFS-VCRC	810017312	15"

DuraFlex SS Cap

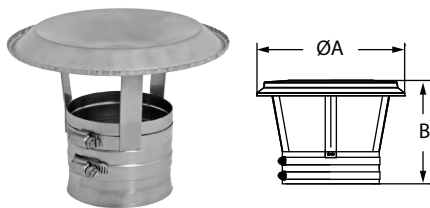

Use to terminate a relining system at the top of the masonry chimney. Supports flex with a fast connect band. Optional Spark Arrestor available. Use to support liner from the top and form a seal between the Storm Collar and the Top Plate. Top is removable for easy access to chimney cleaning.

SIZE	ORDER #	STOCK #	A	B
10"	10DFS-RCSC	810016941	19"	8"
12"	12DFS-RCSC	810016943	21"	8"

Spark Arrestor

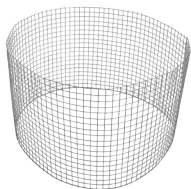

Use on inside of cap. Optional Spark Arrestor may be required. For 3"-8" diameters. Trim length to fit specific size.

SIZE	ORDER #	STOCK #
3"-8"	DFS-SA	810002428

Sleeve

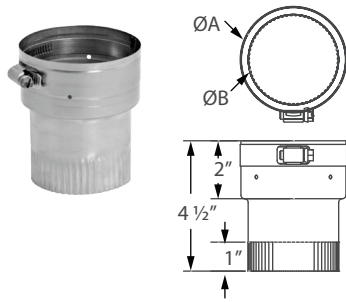

Use to connect a liner into an appliance flue collar.

SIZE	ORDER #	STOCK #	A	B
4"	4DFS-SLV	810016910	4 1/8"	4"
5"	5DFS-SLV	810016911	5 1/8"	5"
5 1/2"	55DFS-SLV	810016912	5 3/4"	6"
6"	6DFS-SLV	810016913	6 1/8"	6"
7"	7DFS-SLV	810016914	7 1/2"	7"
8"	8DFS-SLV	810016915	8 3/16"	8"
10"	10DFS-SLV	810016917	10 3/16"	10"
12"	12DFS-SLV	810016919	12 1/4"	12"

Tee w/ Removable Snout



Use as a 90° transition between liner and connector pipe at the wall thimble or rear flue outlet of a heater. Removable Snout with internal draw band allows for easier, through the wall thimble installation.

SIZE	ORDER #	STOCK #	ORDER #	STOCK #	A	B	C
10"	10DFS-TRS	810016929	10VG-TRS	810001889	10 3/16"	10 1/8"	16 1/2"
12"	12DFS-TRS	810016931	12VG-TRS	810001905	12 1/4"	12"	18"

Tee Cap

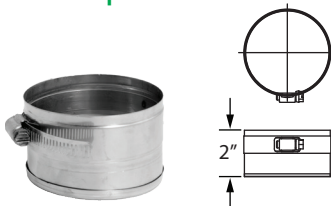

Attach to bottom of tee body. Provides access for cleaning.

SIZE	ORDER #	STOCK #
10"	10DFS-TCV	810016933
12"	12DFS-TCV	810016935

Long Tee Snout



Use to increase reach through masonry at wall thimble.

SIZE	ORDER #	STOCK #
10"	10DFS-TLS	810016937
12"	12DFS-TLS	810016939

DuraFlex Mortar Sleeve

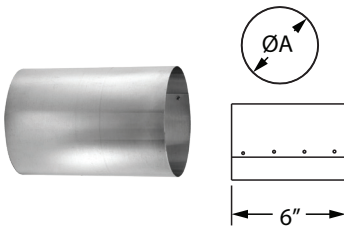

Use to protect DuraFlex when passing length through a masonry wall.

SIZE	ORDER #	STOCK #	A
3"	3DFS-MS	810002425	4"
4"	4DFS-MS	810002433	5"
5"	5DFS-MS	810002443	6"
5 1/2"	55DFS-MS	810002452	6 1/2"
6"	6DFS-MS	810002462	7"
7"	7DFS-MS	810002471	8"
8"	8DFS-MS	810002479	9"

DuraFlex Flex Puller

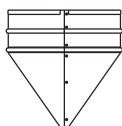

Use with a rope to guide DuraFlex lengths down masonry chimney.

SIZE	ORDER #	STOCK #
3"	3DFS-FP	810002426
4"	4DFS-FP	810002434
5"	5DFS-FP	810002444
5 1/2"	55DFS-FP	810002453
6"	6DFS-FP	810002463
7"	7DFS-FP	810002472
8"	8DFS-FP	810002480
10"	10DFS-FP	810016960
12"	12DFS-FP	810016962

Insulation

TherMix



Use to fill space between a liner and inside masonry chimney. Ready-mix formula cures into lightweight. Semi hard mass that insulates the liner and dissipates the intense heat created in a chimney fire.

*Use Table 1 to estimate the number of TherMix bags or boxes needed to do the job.

- Find the flue opening that comes closest to the one being lined, the left hand column.
- Find the size of the liner to be installed across the top line.
- Where the values intersect, read the cubic foot volume of TherMix per foot of chimney height.
- Multiply this volume by the height (in feet) of the chimney.
- Divide the cubic feet calculated in the previous step by 3.25. This answer will determine the number of bags/boxes of TherMix needed.

SIZE	ORDER #	STOCK #
BAG	RNS-TMG	810001820
BOX	RNS-TMX	810001821

Example:

A 28' chimney with a flue opening of 8.5" x 8.5" is to be lined with a 6" liner. As shown in Table 1, .30ft³ of TherMix is needed per foot of chimney height. Multiply .30 by 28 (the height of the chimney), to get 8.4ft³. Now divide 8.4 by 3.25 (the approximate volume yield per bag of TherMix), to obtain 2.6 bags/boxes of TherMix to complete the installation.

*Masonry chimneys are not uniform structures. Have extra bags/boxes available in case you need them. If there is an installation not covered by table 1, refer to the formula below:

$$\text{Packages of TherMix} = \frac{(W \times D \times H) - (CS \times H)}{1728 \text{ cu. in.}} \div 3.25$$

- W = Width of flue opening (in inches)
- D = Depth of flue opening (in inches)
- H = Height of flue (in inches)
- CS = Cross Section areas of chimney liner (table 2)

TABLE 1: THERMIX VOLUME PER ONE FOOT OF CHIMNEY HEIGHT

Flue Opening	Diameter of Liner					
	5"	6"	7"	8"	10"	12"
7.5" x 7.5"	.25	.20	--	--	--	--
7.5" x 11.5"	.46	.40	(Ovalized) .38	(Ovalized) .32	--	--
8.5" x 8.5"	.36	.30	.23	--	--	--
8.5" x 11.5"	.54	.48	.41	(Ovalized) .36	(Ovalized) .33	--
9.5" x 9.5"	.49	.43	.36	.27	--	--
11.5" x 11.5"	.78	.72	.65	.60	.37	--
11.5" x 16.5"	1.18	1.12	1.05	.96	.77	--
12.5" x 12.5"	.95	.88	.82	.73	.53	--
14.5" x 14.5"	1.30	1.26	1.20	1.10	.92	.65
14.5" x 18.5"	1.70	1.66	1.60	1.50	1.30	1.04

TABLE 2: CROSS SECTION AREA OF LINER

Liner Size	CS Area	Oval Liner Size	Oval Dimensions	CS Area
Round 5"	19.62in ²			
Round 6"	28.46in ²	Oval 6"	(4.2" x 7.2")	24.60in ²
Round 7"	38.46in ²	Oval 7"	(4.2" x 9.1")	32.20in ²
Round 8"	50.25in ²	Oval 8"	(4.2 x 10.3")	37.20in ²
Round 9"	62.50in ²			
Round 10"	78.50in ²	Oval 10"	(4.2" x 13.3")	49.50in ²
Round 12"	113.22in ²			

ProMesh Insulation Kit



3" - 6" Diameter Insulation Kit includes: 22"x 25 Feet of ProFoil, 12" x 25 Feet ProMesh, and 2" x 150 Feet AL tape

SIZE	ORDER #	STOCK #
3" - 6"	6RNS-IK	810012842

ProFoil



Use as insulator for stainless steel liners in masonry chimneys. UL Listed insulation. Size is based on vent diameter.

Required to insulate stainless steel liner to meet UL 1777 when proper clearances to chimney and framing are not available. 1" clearance from SS liner to interior wall of the masonry chimney and 1" clearance from the masonry to the house framing are required in order to meet UL 1777. If you do not have either of these clearances then a 1/2" wrap is required. If these two clearances are available then no insulation is needed. AluFoil Tape and ProMesh required.

SIZE	FITS Ø	THICKNESS	ORDER #	STOCK #
22"x25'	3"-5 1/2"	1/2"	56RNS-PFB22X25	810001822
24"x25'	6"	1/2"	7RNS-PFB24X25	810001823
29"x25'	7"	1/2"	8RNS-PFB29X25	810001824
48"x25'	8"-12"	1/2"	912RNS-PFB48X25	810001825

AluFoil Tape



Use to seal seams of ProFoil insulation. 2 mil aluminum foil tape has strength and adhesion.

SIZE	ORDER #	STOCK #
3" x 150'	RNS-ALF	810002486

ProMesh



Use to protect the ProFoil during installation. 304 stainless steel mesh slides over insulated liner. Shrinks to fit liner when pulled length-wise.

SIZE	ORDER #	STOCK #	LENGTH
SM - for Ø3"-Ø 6"	RNS-PM1	810012553	25'
LG - for Ø7"-Ø9"	RNS-PM2	810012554	25'
XLG - for Ø10"-Ø12"	RNS-PM3	810012555	25'

What makes us different from the rest?

DuraFlex: A range of flexible stainless steel relining to make the right decision for the right situation.



100% manufactured in the USA

Four DuraFlex liners and a complete selection of universal components.

Limited Lifetime Warranty

Ovalize first 4' of flex length

Offers both strength and flexibility facilitating problem free installations

Create your own personalized, custom kit to fit your installation requirements

DuraFlex Feature	Benefit	DuraFlex Feature	Benefit	DuraFlex Feature	Benefit
Flexible installation	DuraVent offers the installer a range of products to make the right decision for the right situation offering four different DuraFlex liners and a complete selection of universal components.	Alternative lining materials to clay tiles	DuraVent liners are tested and listed as alternative lining materials to standard clay tiles and can be installed into existing clay tiles or clay tiles may be removed and replaced with a DuraVent liner.	Built-in draw band	DuraVent caps and tees are manufactured with built-in draw bands, eliminating the need for pre-drilling liners or using pop rivets.
Custom lengths and kits	All DuraFlex is available for orders requiring custom lengths eliminating the need to cut lengths in the field.	Smooth wall option	The smooth inner wall provides for no output reduction allowing for full appliance efficiency and does not include ridges that restrict flue gas flow and collects deposits. Lack of ridges facilitates cleaning and maintenance.	Self-straightening liner	DuraFlex Pro is extremely flexible that self straightens when taken out of the box. There is no need to wrestle with the liner to get it straightened out. Little to no machine oil residue left on liner.
Custom kits	Combine any DuraFlex liner and length with any DuraFlex accessories to create your own personalized, custom kit to fit your installation requirements.				
Oval Options	Ovalize first 4' of flex length.	Combination of strength and flexibility	DuraFlex Pro offers both strength and flexibility, featuring 20% more stainless steel per foot compared to other liners on the market. Its extreme flexibility facilitates problem free installations where multiple offsets are needed.	Limited Lifetime Warranty	The best Warranty in the industry. 15 years 100%, 15 years and up 50%. Gives the installer and home owner the greatest peace of mind in a quality installation.
UL1777 and ULC S635 listed	DuraLiner meets all the thermal, mechanical and material requirement of the UL1777 and ULC S635 (MH14420) standards.			Made in USA	100% manufactured in US



DuraVent[®]

www.duravent.com | 800-835-4429



Catalog_DuraFlex_02-2022