

ULTRA-ZONE[®] Forced Air Zone Controls

The model DAPC can monitor your HVAC system static pressure and the zone damper “Open & Close” commands from your EWC[®] Zone Controller. When the static pressure gets too high, the DAPC will modulate “Float” any Closed zone dampers towards the Open position, in order to control the static pressure. Use the DAPC’s default static pressure set-point (0.5”wc) or select a set-point from the menu. If preferred, customize and let the DAPC “discover” the actual “non-zoned” static pressure of your HVAC system, and adopt that value as the static pressure set-point. If you don’t have enough room to install a bypass, the DAPC is your best airflow management solution..

Zone Capacity

Modulate 1, 2 or 3 large air zones with 24vac Power Open / Power Close “Floating Point” motor actuators. *eg, MA-ND5 or MA-15S.*

Compatible Zone Controllers

The DAPC is compatible with all 24vac zoning systems when genuine Ultra-Zone[®] model ND, URD or SID dampers are specified and installed. (*MA-ND5 or MA-15S motor actuators*).

Round and/or Rectangular Dampers by zone

All zone dampers in a building are usually the same type, either round or rectangular. The DAPC can handle Round dampers on one zone and Rectangular dampers on another zone. If both damper types exist on one or more zones, use the default “linear” setting rather than “round” or “rectangular”.

Static Pressure Set-Point

The DAPC default static pressure set-point is 0.5”wc. You can select your own set-point from a wide range (.15”wc to 1.50”wc). If you prefer, the DAPC can “discover” the non-zoned static pressure of your HVAC system and adopt that value as the operating static pressure set-point. *See page 8 for details.*

Status LCD

System SP: 0.52"

The liquid crystal display scrolls to show the HVAC system *Static Pressure* versus the *Static Pressure Set-Point*. Real time damper position “*Open, Closed or Floating*” can be viewed by hitting the UP button. All DAPC programming is viewed on the LCD screen.

4 Button LCD Programming

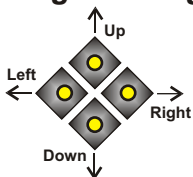

Four buttons are provided below the LCD screen to access the DAPC menu, choose your settings and observe damper input and output position (status).

Non-volatile memory will retain your menu settings even after a prolonged power failure.



Figure 1. DAPC Distributed Air Pressure Controller

Damper LED's

Three easy to observe LED's labeled Zone 1, Zone 2 and Zone 3, provide “status” of which zone dampers are Open, Closed or Floating. *Green = Open, Red = Closed, Flashing Green/Red = Floating.*

Intuitive Default Programming

The DAPC comes pre-loaded with Default Operating Parameters (*See Page 2, Table 1*) for Zoned HVAC Systems. Default Programming means less work for the Installer, but still allows fine tuning to optimize performance and achieve personal preference. Simply decide which “large” zones you want the DAPC to modulate “float”, when the static pressure gets to high.

Select the zones you want to modulate

The average zoned home has 2 or 3 zones. Sometimes the percentage of airflow (cfm) required for each zone is roughly the same (50/50 or 60 /40). Quite often the airflow ratios are very different (80/20, 70/30, 60 /30/10).

Because large zones can handle periodic overflow (excess air) without over-conditioning, but small zones may not, the DAPC lets you select which zones are allowed to modulate and which cannot! Both zones should modulate on a (60/40 or 50/50) two zone system, but only modulate the largest zone on a (80/20) two zone system.

INSTALLATION INSTRUCTIONS - Licensed Technician Required!

MOUNTING: Choose a suitable location to install the DAPC housing. Attics, basements and dry crawl space installations are allowed. Mount the DAPC in close proximity to the zone controller, on the return duct, a wall stud, sheet-rock or plywood. **Do Not** mount the DAPC directly to the Supply duct, Furnace, Air-Handler, Hydronic Coil Cabinet or Evaporator Cabinet. **Do Not Mount** the DAPC inside any "open or ducted" return air stream. Follow National and/or Local Mechanical & Building Codes.

POWER SUPPLY: The DAPC **must** share 24vac power, from the new or existing Ultra-Zone controller. All Ultra-Zone controllers require a dedicated transformer which must be used to power the DAPC as well. If the zone controller does not have a dedicated UL listed transformer (40va minimum - 75va maximum) then you must install one! **Do Not Rob 24vac power from the HVAC system!** Failure to power the Zone controller and the DAPC with a dedicated transformer will void both warranties! Follow National and/or Local Electrical Code.

WIRING: Use standard 18awg solid copper multi-conductor cable. Plenum rated where applicable. Connect the dedicated 24vac Power Supply to the DAPC and wire-up the dampers. Use the side or rear openings provided on the housing as the wire entry-way. Strip the cable's jacket back to the point where the cable enters the housing. This reduces bulk and allows easier routing & termination of the individual wires for a professional looking installation. Follow National and/or Local Electrical Code.

Plug & play: The DAPC default factory settings work fine for most applications. All zones are set for "linear" damper operation, although you may decide to select Round, Rectangular or a mix instead. The Response Delay and Hysteresis settings are already optimized for you and the default static pressure set-point is 0.5"wc. If you need to change these settings, access the program menu and select your desired settings. The DAPC will save them automatically. If you want to start over from scratch, you can default the DAPC back to the factory settings at any time.

FINISH: Run the system thru it's paces and confirm that the DAPC is controlling the system static pressure (at the desired set-point) in every zoned mode of operation. Check all Zone Dampers for proper floating operation. Adjust the menu settings if needed.

Model DAPC Version 1.22 SPECIFICATIONS and MENU ITEMS:

Zone Capacity: Maximum 3 "floating" zones on a single DAPC. Two or more DAPC's can be installed on a single system, to modulate "float" up to nine zones.

Power Supply: Powered from a new or existing zone controller's "dedicated" 24vac Transformer. (Min. 40va Max. 75Va 50/60 Hz)

DAPC Current Draw & Wattage: 145mA (0.145A) / 3.5va power requirement without dampers.

Compatible Dampers: Ultra-Zone® URD, ND, and SID dampers, with MA-ND5 or MA-15S Floating Point motors.

NOTE: 2 or 3 WIRE "SPRING TYPE" DAMPER MOTORS ARE NOT COMPATIBLE!

Maximum Number of Dampers @ 40va power supply: Up to 5 ND, URD, or SID Dampers Per Zone @ 1.5va per motor. **Total 15.**

Maximum Damper Motors per Zone @ 75va power supply: Up to 9 ND, URD, or SID Dampers Per Zone @ 1.5va per motor. **Total 27.**

Over-Current (Auto-Reset) Protection:
200mA Over Current protection for DAPC logic circuit.
500mA Over Current protection per Zone Damper output.

Ambient Operating Conditions:
TEMPERATURE: 0°F to 160°F (-17° to 71°C).
HUMIDITY: 0% - 95% Rh Non-Condensing.
Not rated for wet conditions.

Calibration: Field calibration is not required.

Housing Specifications:
High Strength, Impact & UV resistant Polystyrene

- Accessories Included:**
- 2 - duct mount pitot tubes 1/4"OD.
 - 1 - 16ft length pressure hose (clear) 1/4"ID x 3/8"OD.
 - 2 - barb fittings (pre-installed) 1/4"OD.
 - 1 - Technical Bulletin

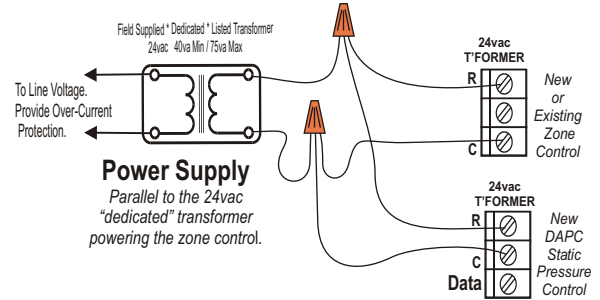
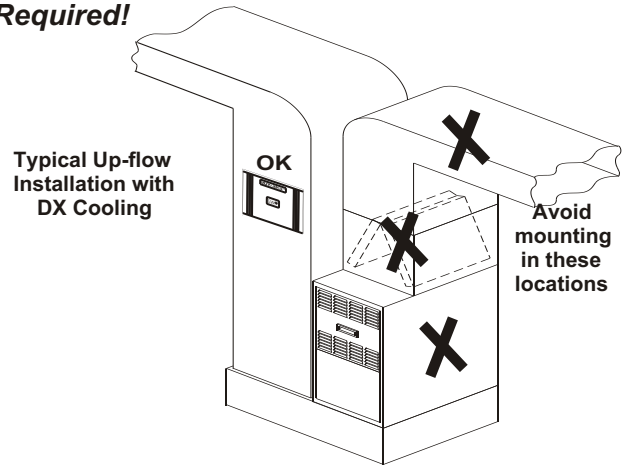
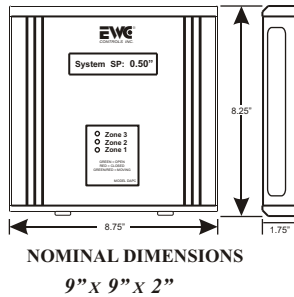

Default Loaded If desired, you can reset the DAPC back to factory settings!

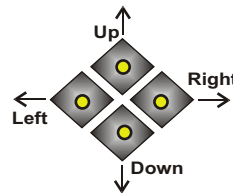

Upon Power Up, Press and Hold the Left & Right buttons to Load the Factory Default Values, then Release.

Use the Left and Right buttons to navigate through the DAPC menu and find the "function" you want to change. Then use the Up or Down buttons to change the value of that function. Your changes will be saved automatically.

Distributed Air Pressure Controller Menu

FUNCTION	DEFAULT	RANGE TO SELECT
LCD Contrast	22	15 - 30
Target Set-Point	0.5"wc	0.15"wc - 1.50"wc
Close Delay	30 seconds	0 seconds - 240 seconds
Response Delay	1 second	1 second - 10 seconds
Z1 Damper	Linear	Linear or Square or Round
Z2 Damper	Linear	Linear or Square or Round
Z3 Damper	Linear	Linear or Square or Round
Z1 Stroke	35 seconds	15 seconds or 35 seconds
Z2 Stroke	35 seconds	15 seconds or 35 seconds
Z3 Stroke	35 seconds	15 seconds or 35 seconds
Z1 Float Enable	Z1 Float with SP	Z1 Float with SP or Z1 Do Not Float
Z2 Float Enable	Z2 Float with SP	Z2 Float with SP or Z2 Do Not Float
Z3 Float Enable	Z3 Float with SP	Z3 Float with SP or Z3 Do Not Float
Hysteresis +/-	5%	2% - 10%
Commission	NO	Press the left or right button to find *Commission NO* Push the UP button once, to activate *Commission YES*

DAPC Features at a Glance

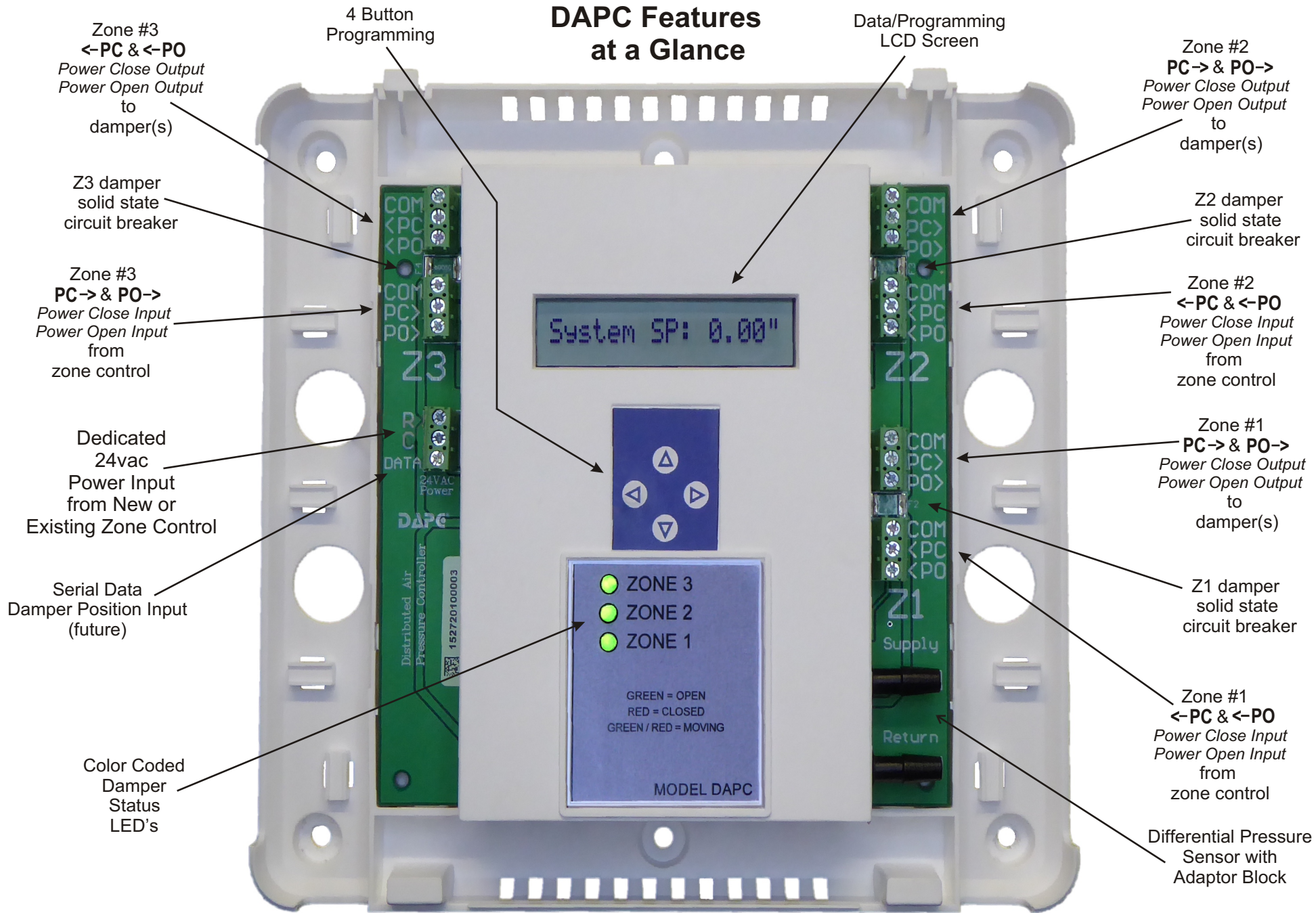

Quick Installation Guide

NEW INSTALLATIONS

- Power down the HVAC system and lock-out all power sources for safety.
- Install the DAPC and the Zone Controller in close proximity to each other and close proximity to the HVAC indoor equipment. DO NOT mount the Zone Controller or the DAPC directly to any heat exchanger, furnace, air handler or supply duct plenum. **Do Not** mount either controller in any “open or ducted” return air stream.
- **Provide a dedicated 24vac transformer** (40va min - 75va max) to power the DAPC and the Zone Controller. DO NOT piggy back to the 24vac power from the HVAC system.
- Route the 24vac power wiring from the dedicated 24vac power source, to the DAPC **and** the Zone Controller. Make parallel wire connections rather than series. See page 13, Power Supply diagram.
- Install the supplied pitot tubes into the primary Supply and Return duct plenums. Connect the supplied pressure tubing from each pitot tube to the “Supply” and “Return” barb fittings on the DAPC. See page 12, Pressure Sensing diagram.
- Route all damper wiring (or only the largest damper(s) wiring) from each zone damper terminal block on the Zone Controller, to the matching zone damper **input** on the DAPC. See pages 14 - 18.
- Route the damper wiring from each zone damper **output** on the DAPC, to the matching zone damper motor. See pages 14 - 18. Determine the stroke time (15s or 35s) of the damper motors and be ready to program the DAPC for that value, after you power up the system. Default is 35 second.
- Finish by wiring each zone thermostat and the HVAC system to the Zone Controller. Guidance for Zone Controller wiring can be found in each respective Zone Controller’s Technical Bulletin.
- Step back and review the installation. Confirm that all wiring is correct and the pitot tubes and related tubing are properly connected. If so, then power up. If not, correct as necessary.
- Start the HVAC system by confirming that ALL zone thermostats are actively demanding the same mode of operation. Confirm that ALL zone dampers are open, and the HVAC system is running at 100% BTU/CFM capacity. If so, proceed to the next step. If not, then re-check all zone thermostat wiring, including each thermostat’s programming and the zone controller’s programming as well.
- Set the DAPC into commission mode (see pages 8, 9 & 10) and allow the DAPC to discover the actual static pressure of the HVAC system. Closely observe all zone dampers as the DAPC opens and closes them, allowing you the opportunity to visually confirm proper operation.
- During the commission process, zone dampers that are routed thru (controlled by) the DAPC, should Open & Close. Zone dampers that bypass the DAPC should remain Open.
- If commissioning was successful, the DAPC will display the new (adopted) static pressure set-point and the installation is now complete.
- If commissioning was unsuccessful, the DAPC will maintain the default target static pressure set-point (0.5”wc) and operate normally anyway. You can also select your own set-point or try again.
- Inspect all damper wiring (zone controller to the DAPC and out to the dampers). Repair any mis-wiring and repeat the commission process again. If still unsuccessful, so long as all zone dampers are modulating properly and the selected set-point is being maintained, the installation is complete.

Quick Installation Guide

EXISTING INSTALLATIONS

- Power down the HVAC system and lock-out all power sources for safety.
- Install the DAPC in **very** close proximity to the existing zone controller. DO NOT mount the DAPC directly to any heat exchanger, furnace, air handler or supply duct plenum. Neither controller should be mounted in any “open or ducted” return air stream.
- **Confirm the existing zone controller is powered by a dedicated 24vac transformer (40va min - 75va max).** If the existing zone controller is stealing 24vac power from the HVAC system, STOP the DAPC installation until a dedicated 24vac transformer is installed. This dedicated 24vac transformer will power the DAPC and the Zone Controller. DO NOT piggy back to the 24vac power from the HVAC system.
- Route the 24vac power wiring from the dedicated 24vac power source, to the DAPC **and** the Zone Controller. Make parallel wire connections rather than series. See page 13, Power Supply Diagram.
- Install the supplied pitot tubes into the primary Supply and Return duct plenums. Connect the supplied pressure tubing from each pitot tube to the “Supply” and “Return” barb fittings on the DAPC. See page 12, Pressure Sensing diagram.
- Re-route all damper wiring (*or only the largest damper(s) wiring*) from each zone damper terminal block on the Zone Controller, to the matching zone damper **input** on the DAPC. See pages 14 - 18.
- Disconnect each existing (*selected*) damper cable from the Zone Controller damper motor terminal block and re-connect that cable to the zone damper **output** terminal block on the DAPC. If you do not have enough slack in the cable, you may have to splice the wires or run a new cable from each DAPC **output** to each existing damper motor. Repeat this process for all zones or the largest zones.
- Route new damper wiring from each vacant Zone Controller damper motor terminal block, to the respective zone damper **input** on the DAPC. Repeat this process for each selected large zone that was disconnected from the existing zone controller. See pages 14 - 18.
- Determine the stroke time (15s or 35s) of the damper motors and be ready to program the DAPC for that value, after you power up the system. Factory default is 35 second.
- Step back and review the installation. Confirm that all wiring is correct and the pitot tubes and related tubing are properly connected. If so, then power up. If not, correct as necessary.
- Start the HVAC system by confirming that ALL zone thermostats are actively demanding the same mode of operation. Confirm that ALL zone dampers are open, and the HVAC system is running at 100% BTU/CFM capacity. If so, proceed to the next step. If not, then re-check all zone thermostat wiring, including each thermostat’s programming and the zone controller’s programming as well.
- Program the correct stroke time of your dampers into the DAPC. Then set the DAPC into commission mode (*see pages 8, 9 & 10*) and allow the DAPC to discover the actual static pressure of the HVAC system. Closely observe all zone dampers as the DAPC opens and closes them, allowing you the opportunity to visually confirm proper operation.
- During the commission process, zone dampers that are routed thru (*controlled by*) the DAPC, should Open & Close. Zone dampers that bypass the DAPC should remain Open.
- If commissioning was successful, the DAPC will display the new (*adopted*) static pressure set-point and the installation is now complete.
- If commissioning was unsuccessful, the DAPC will maintain the default target static pressure set-point (0.5”wc) and operate normally anyway. You can select your own set-point or try again.
- Inspect all damper wiring (*zone controller to the DAPC and out to the dampers*). Repair any mis-wiring and repeat the commission process again. If still unsuccessful, so long as all zone dampers are modulating properly and the selected set-point is being maintained, the installation is complete.

LCD Screen Programming

Use the *Left & Right* buttons to navigate thru the Menu Functions. Use the *Up & Down* buttons to change or adjust the options available in that function. Select only the functions you want or need. **For future reference, write the selected value in the box.** Your changes will take effect in real time and the DAPC will remember your settings even after a power failure.

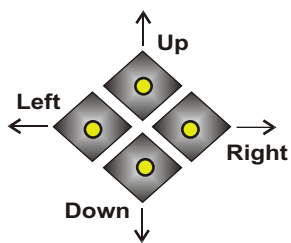

4 Button LCD Programming

LCD Contrast 22

The LCD contrast is already set for you at the factory. If you need to adjust the contrast, use the Up or Down buttons.

TRGT SP: 0.50"wc

The Target Static Pressure set-point is factory set at 0.5"wc. This is an industry standard for residential HVAC systems. If you need to adjust the set-point, use the Up or Down buttons.

CLOSE DLY 30s

When the zone controller commands a zone damper to close, the DAPC will comply and start closing that zone immediately, or you can set a "close delay" up to 4 minutes.

Some zone controllers can force a multi-stage HVAC system to "stage down", as zones satisfy, which reduces BTU capacity and airflow.

However, certain HVAC systems can take awhile (up to 3min) before staging down and reducing airflow. So, if you impose a sufficient time delay *before* closing the zone damper (*give the indoor fan a chance to slow down*) the airflow and static pressure will decrease *before* that damper is commanded to close. This means the DAPC might be able to fully close that zone damper, rather than "float it" back open again. *Default setting is 30 seconds.*

RESPONSE DLY 1s

The Response Delay is a forced rest period (pause) in between commands to float (*modulate*) any inactive zone damper motor(s). The response delay is always enforced when the system static pressure is **within** the selected hysteresis range. (*See page 8*). When the system static pressure is **beyond** the hysteresis range, the DAPC will stroke the damper motor(s) in a quick continuous movement (*non-stop*), if all zone damper settings are the same type and speed (*ie, Round 35s*). Otherwise, the selected response delay will be enforced.

Z1 Damper Linear

Linear is the "default" damper type setting (*rather than round or square*) which may provide the best damper performance for your system. "Linear" disregards the airflow performance of round/square dampers. Linear setting is advised with different damper types in the house or on the same zone. Be sure to set the correct stroke time for each damper motor type. *See page 7.*

Z2 Damper Round

If preferred you may set each zone for the type of damper(s) installed in that zone. Typically all installed zone dampers are the same type, but zone damper types can differ depending on the duct-work configuration in the building. *The DAPC allows you to specify which damper type are installed in each zone.*

Z3 Damper Square

Square/Rectangular dampers have different airflow performance than round dampers. The DAPC knows this and will operate each damper based on it's performance curve. But the DAPC will operate dampers a bit slower when different damper types exist on each zone. If this becomes an issue, select the Linear setting instead.

LCD Screen Programming

Use the *Left* & *Right* buttons to navigate thru the Menu Functions. Use the *Up* & *Down* buttons to change or adjust the options available in that function. Select only the functions you want or need. ***For future reference, write the selected value in the box.*** Your changes will take effect in real time and the DAPC will remember your settings even after a power failure.

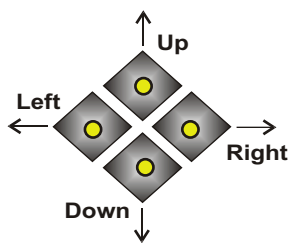

4 Button LCD Programming

Zone1 Stroke 35S

You must select the speed of your damper motors, in the DAPC menu. The default setting is 35 seconds. Standard Ultra-Zone damper models are rated at 35 second stroke time, but 15 second actuators are also available from EWC and work very well on the DAPC.

Zone2 Stroke 15S

The DAPC can accommodate different speed damper motors on different zones. (*Zone 1 = 35s, Zone 2 = 15s & Zone 3 = 35s*). Although it would be very unusual because most damper motors on the job site will be the same type & speed.

Zone3 Stroke 35S

Floating point damper motors are rated at a specific speed or travel time. (*35 seconds, 15 seconds, etc*). Just as most installations will have the same damper type (*round or square/rectangular*), most damper motors on the job site will be the same speed or travel time.

The DAPC cannot accommodate *different motor speeds on the same zone*. (*35s and 15s motors on the same zone*). It would be very rare to run across this type of installation in the field anyway. If you do, one or more of the existing damper motors will have to be replaced, so all dampers on a particular zone are the same speed.

Z1 Float with SP

Or

Z1 Do Not Float

You can specify which zones are allowed to float (*in order to control the static pressure*) and which zones cannot float. This will be useful if one of the zones is small (low CFM) and floating that zone results in a temperature over-shoot condition.

Z2 Float with SP

Or

Z2 Do Not Float

On a Two Zone system where both zones are somewhat equal in design CFM, allow both zones to float in order to control the static pressure. A two zone system where Zone 1 has high CFM requirement and Zone 2 has a low CFM requirement, only float Zone 1.

Z3 Float with SP

Or

Z3 Do Not Float

On a Three Zone system where two of the zones (*ie 1 & 2*) have high CFM requirements, but Zone 3 has a low CFM requirement, don't float Zone 3.

You should float all three zones if the required CFM is somewhat equal in design CFM requirement.

LCD Screen Programming

Use the *Left & Right* buttons to navigate thru the Menu Functions. Use the *Up & Down* buttons to change or adjust the options available in that function. Select only the functions you want or need. ***For future reference, write the selected value in the box.*** Your changes will take effect in real time and the DAPC will remember your settings even after a power failure.

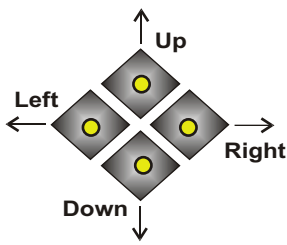

4 Button LCD Programming

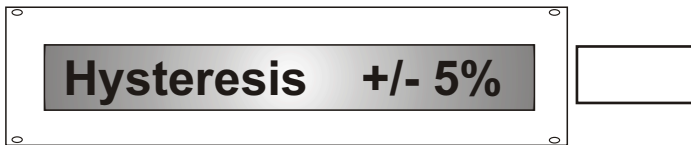

Select the hysteresis (differential) setting on the DAPC. The factory default is 5%. The hysteresis determines how accurate, the DAPC will maintain the actual HVAC system static pressure, versus the static pressure set-point. For high to moderate accuracy, select a 2% to 5% value. Higher hysteresis settings will result in a lower level of accuracy. Extremely low hysteresis settings may result in excessive damper movement.

If all damper settings are the same type (*ie, round, square, linear*) and the same speed, the DAPC will stroke the zone dampers “non-stop”, when the actual static pressure is beyond the selected hysteresis range. This brings the static pressure back into regulation (*hysteresis range*) very fast!.

Once the static pressure is within the hysteresis range, the DAPC will stroke the dampers incrementally (*slower*) with a brief pause in between each stroke. This brief pause is the selected Response Delay setting. (*See page 6*).

If the damper settings are different types and/or different speeds (*Z1 35s, Z2 15s, Z3 35s*), then the DAPC will stroke the dampers in 1 second intervals (*rather than non-stop*) when the actual static pressure is beyond the selected hysteresis range. This brings the static pressure back into regulation (*hysteresis range*) quickly, but not as fast as when all zones are the same type and speed. Once there, the DAPC will stroke the dampers incrementally (*slower*) with a brief pause in between each stroke. This brief pause is the selected Response Delay setting. (*See page 6*).

NOTE: If you have different damper types but they are all the same speed, selecting “linear” as the damper type for all zones, will achieve faster damper movement and static pressure regulation. (*See page 6*).



Go to the next page and follow the instructions to “commission” the zone dampers!

Commissioning provides you the opportunity to observe each zone’s damper incremental movement and confirm the correct “open/close” operation for each zone.

You can immediately identify and repair any zone dampers that do not move properly and repeat the commission process again to double check your work. Each successful commission process overwrites the previous one.

Commissioning also “discovers” the non-zoned (*actual*) static pressure of your HVAC system, which is better than using the default set-point or guessing.

So create a new target static pressure set-point that is customized to your duct-work and zoned HVAC system!









The DAPC will discover this value, add a small percentage to it, and then adopt that value as the customized static pressure set-point for your zoned HVAC system.

In addition, a successful commissioning, includes measuring and storing the calculated percentage of static pressure that each zone can handle. The values are expressed as “zone weight” in the DAPC’s menu and can be used to set the zone weight values on the patented UT3000 zone controller. (*See pages 9 & 10*).

Go to page 9 for “Damper Commissioning”.

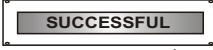
Damper Commissioning & Static Pressure Discovery

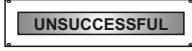
You can commission the floating damper system and discover the “non-zoned” static pressure of the HVAC system in one simple step!

- Set **all** zone thermostats to heat or cool mode, *whichever mode results in the highest airflow*. Make sure the air filter is new/clean, and any ancillary devices (ERV, De-Humidifier, Humidifier) are closed.
- Confirm the HVAC system is running (steady state) at 100% BTU/CFM capacity.
- Navigate (left or right button) to this screen  and press the UP button one time only.
- After pressing the UP button, the screen will change to: 
- The DAPC will now force all zone dampers to the open position and measure the “non-zoned” static pressure system of the HVAC system.
- The DAPC will stroke each zone’s damper(s) to the closed position (*incrementally*) then back open again, one zone at a time.   
- *Watch and observe the dampers move! This useful test can help you confirm that a single damper or multiple dampers on a single zone, are wired correctly and functioning properly.*
- After stroking each zone to the closed position, the DAPC measures the static pressure again, noting the difference (*delta*) from the (all open) static pressure measurement, taken at the beginning of the commission process.
- When all three zones are back open again and the test is complete, the DAPC will display the “” screen **if** the sum of the deltas, matches the original static pressure measurement.
- The DAPC will also display the new (adopted) static pressure set-point. ie, 
- If the sum of the deltas does not match the (all open) static pressure measurement taken at the beginning of the test, it will display the “” screen.
- If unsuccessful, the DAPC will maintain the previously selected (or default) target static pressure set-point and operate normally. ie, 
- Again, you should inspect all connected zone dampers to determine if they are wired correctly and will close & open, when the DAPC commands them to move.
- You can perform the commission process as many times as you like. Each successful commissioning, will over-write the previous one.
- **NOTE:** *Dampers that close but do not open upon command, will result in an “unsuccessful” message! Dampers that open but do not close upon command, may result in a “successful” message! So it’s important to visually observe the process and confirm that ALL zone dampers (connected to the DAPC) open and close, when the DAPC is performing the commission process.*

Damper Commissioning & Static Pressure Discovery

After a successful commission process has been completed, the DAPC will resume normal operation using the new (adopted) static pressure set-point.

In addition, the DAPC has stored the calculated percentage of static pressure that each zone can handle. The values are expressed as “zone weight” and can be used to set the zone weight values on the UT3000 zone controller.



The example zone weight values on the left reflect that all 3 zones are being utilized on the DAPC. All three zones are similar in BTU/CFM requirement. This could also be a 4 or 5 zone system and only the 3 largest zones are routed thru the DAPC for static pressure control.



The example zone weight values on the left reflect that only 2 zones are being utilized on the DAPC. The zones are roughly similar in BTU/CFM requirement. This could be a 2 zone system and zone 3 does not exist or there are some “open duct runs” that receive airflow all the time.



The example zone weight values on the left reflect that all 3 zones are being utilized on the DAPC. This could be a 3 zone system and all 3 zones are routed thru the DAPC for static pressure control. Note zone 3 weight is only 11%, so this zone should not be used for static pressure control.

*Enter the menu and select
“Z3 Do Not Float”.*

LCD System Messages

Once the programming is complete, the LCD screen will scroll to display the actual Static Pressure of the HVAC system versus the default, manually selected or discovered Static Pressure (Target) Set-point.

Other data screens shown below can be accessed by pressing the Up or Down button. You can observe each zone damper Input and Output status, and the commanded damper position. *Note that zone damper Input status is displayed using lower case characters, while zone damper Output status is displayed using upper case characters.*

Below are typical LCD data screen examples:

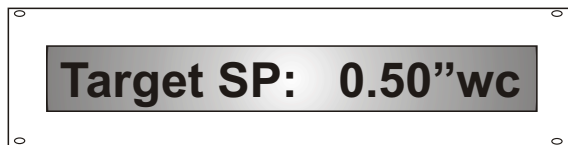

And

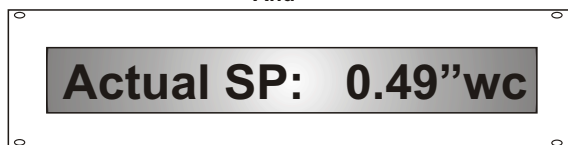

The LCD screen will automatically scroll to display the actual Static Pressure of the HVAC system versus the Target Static Pressure Set-point.

Controlling the system static pressure is the primary function of the DAPC, so it makes sense to display this data all of the time.

Other data screens (Zone Damper Status) can be accessed by pressing the Up or Down button. Zone damper status can also be quickly verified by observing the Damper LED's.

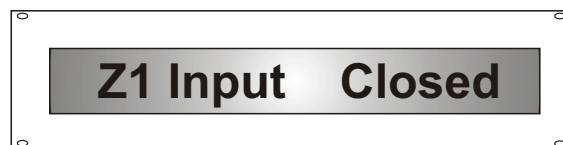
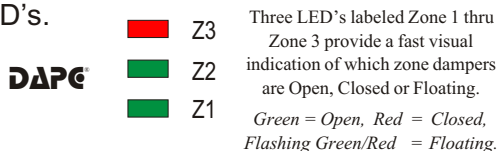

Equals



Or

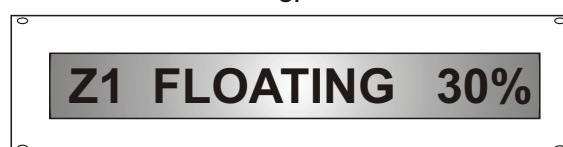

Any zone that is commanded to Close (*by the zone controller*), will be honored by the DAPC, so long as the actual static pressure does not exceed the target static pressure set-point.

While closing that zone (and/or other inactive zones) the DAPC is also monitoring the actual static pressure.

If the actual static pressure exceeds the target static pressure set-point, the DAPC will start floating (modulate open) all eligible "inactive" zones, in order to maintain the static pressure at the target set-point.

The screen above shows the DAPC is floating zone 1 at 30% open, in order to control the static pressure.

The screens below depict a different zone being commanded to close (*by the zone controller*) but the DAPC is floating that zone also, in order to control the system static pressure at the desired set-point.

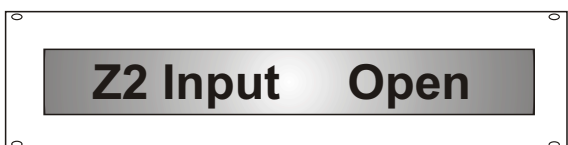

Equals

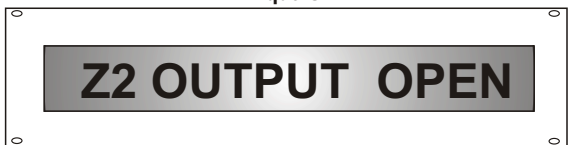

Any zone that is commanded to Open by the zone controller, will always be honored by the DAPC. The respective zone LED will illuminate green, and a 24v signal is sent to open that zone. If the zone damper(s) does not open, check your wiring or you may have a faulty damper motor.

The zone damper INPUT (*coming from the zone controller*) is displayed, as well as the OUTPUT to the zone.

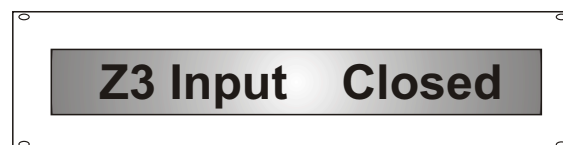

STATIC PRESSURE SENSING

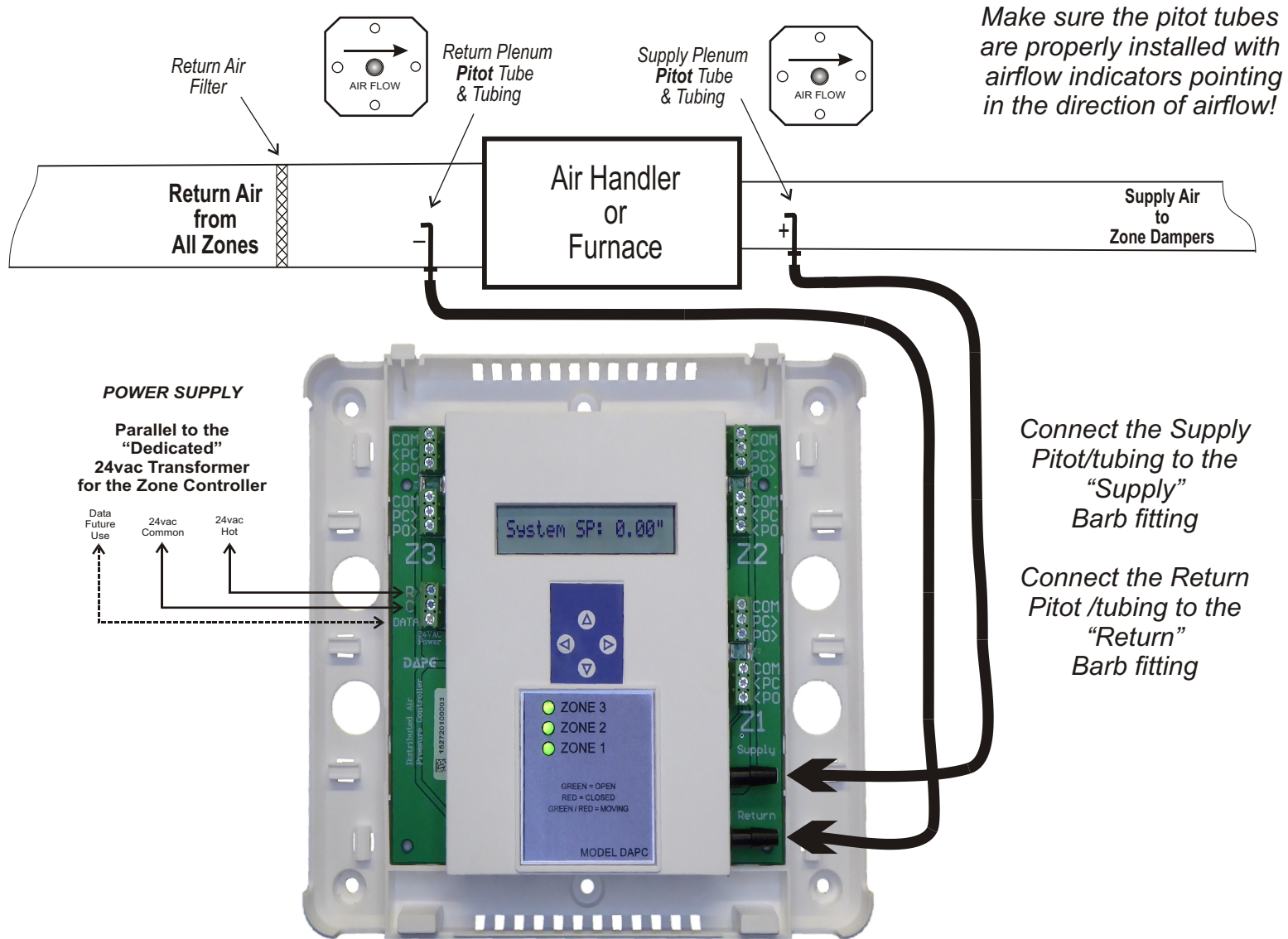

The image above reflects the typical pitot and pressure reference tubing setup. Try to keep the reference tubing as short as possible without kinking. Avoid hot surfaces and sharp objects that may damage the tubing.

**Note that 24vac power supply MUST come from the "dedicated" transformer powering the Zone Controller!
DO NOT steal 24vac from the HVAC system, to power the Zone controller and/or the DAPC!**

POWER SUPPLY

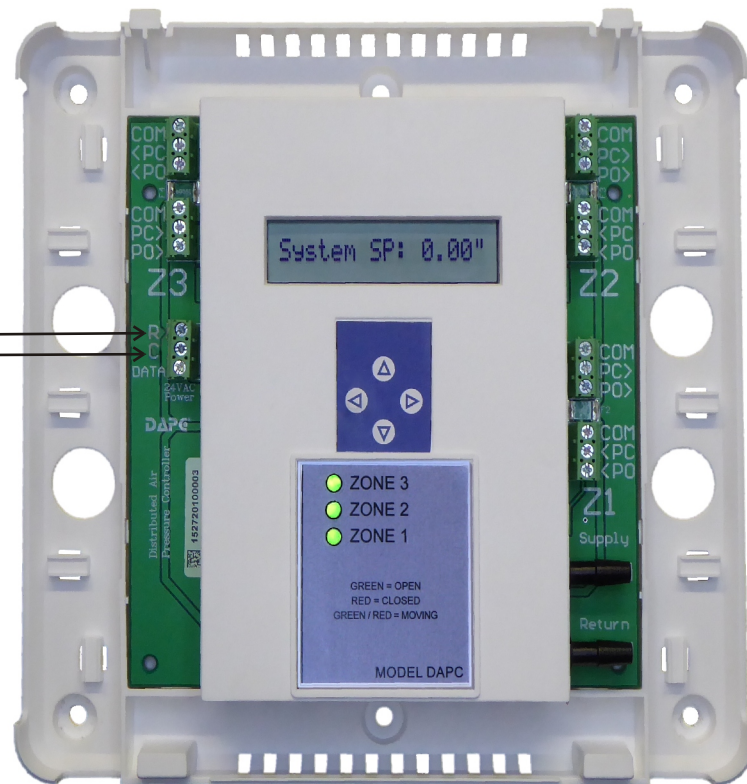
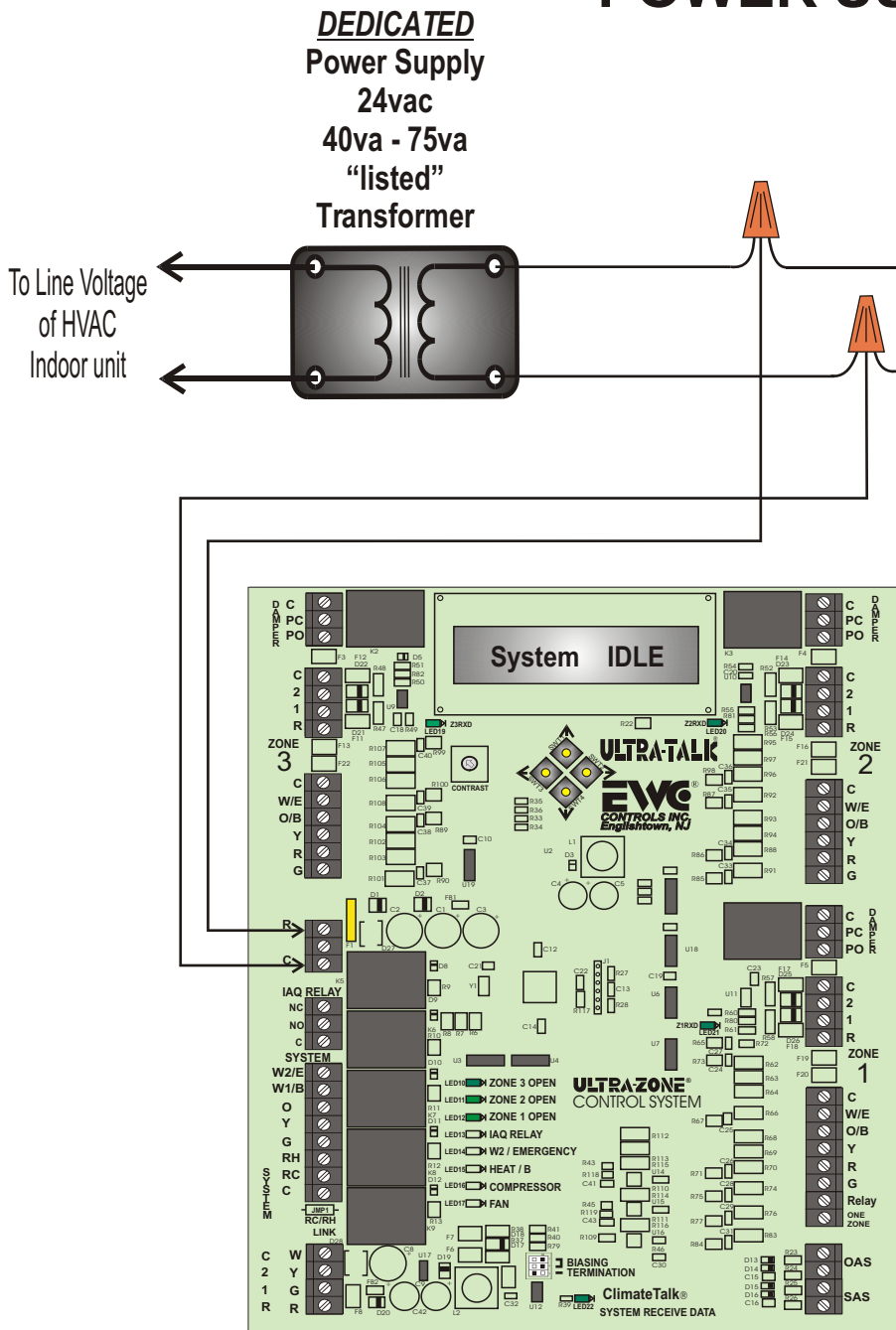

This graphic reflects the specified method to provide 24vac power to the Zone Controller and the Distributed Air Pressure Controller.

Both controllers must be powered from the same "listed" 24vac transformer and be sure to maintain polarity as shown in this graphic.

DO NOT ROB 24vac from the HVAC system!

If you are installing the DAPC on an existing zone control system, inspect the zone controller's 24vac power source first. If you discover the existing zone controller is robbing 24vac power from the HVAC system, stop the DAPC installation!

Install a dedicated 24vac transformer (40va min - 75va max) to power both controllers. You may then continue the DAPC installation.

OTHER LOW VOLTAGE WIRING IS NOT SHOWN FOR CLARITY

DAMPER DIAGRAM (2 zones)

This 2 zone graphic reflects ALL zone damper wiring is routed thru the DAPC. This means that both dampers can float to control the static pressure.

This graphic assumes that both zones are roughly the same size in terms of required CFM.

If zone 1 CFM requirement is "significantly" larger than zone 2 (or vice versa), then the smaller CFM zone could be set to "Do Not Float" if desired.

Ultra-Zone®
Zone 2 Damper

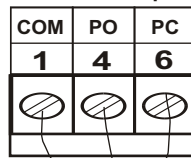

PAY ATTENTION TO YOUR WIRING & MAINTAIN POLARITY!

Some zone controllers have damper output terminals C, PC & PO.

Some zone controllers have damper output terminals M1, M4 & M6.

The DAPC has Input and Output damper terminals Com, PC & PO.

These damper terminals are all the same and perform the same function.

M1 = 1 = C or COM (24v common)
M4 = 4 or PO (24v power to Open)
M6 = 6 or PC (24v power to Close)

The sequence (Com, PC, PO) on the DAPC, may not match the sequence on the Damper Motor (Com, PO, PC). Pay attention to your wiring!

Ultra-Zone®
Zone 1 Damper

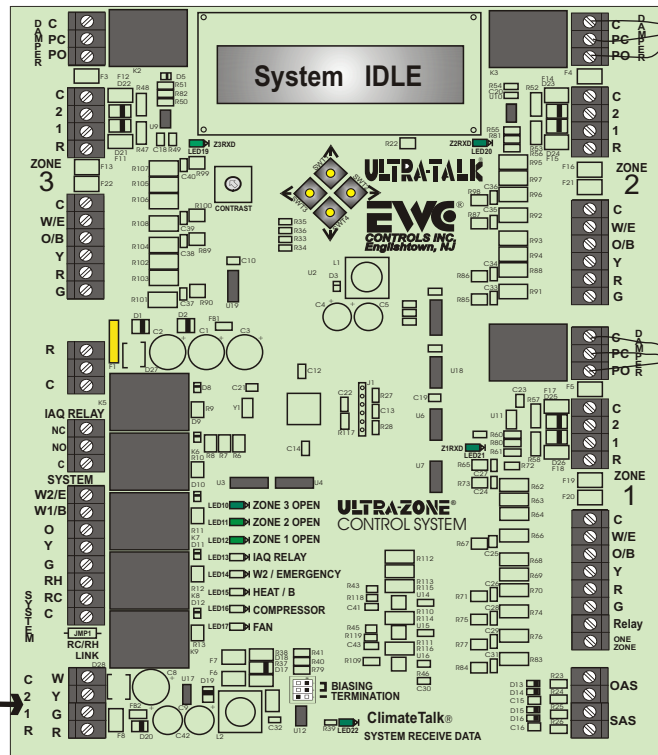
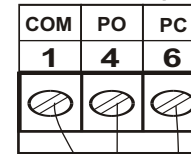

➔ To FIT HVAC system

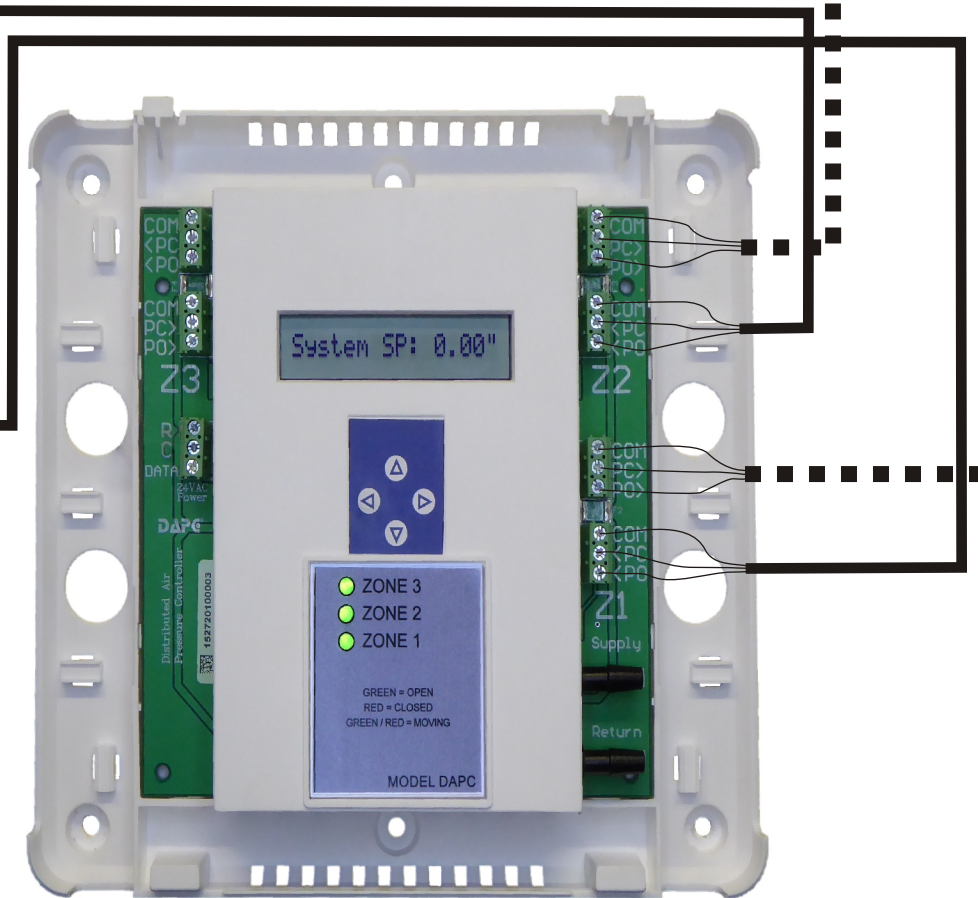

OTHER LOW VOLTAGE WIRING IS NOT SHOWN FOR CLARITY

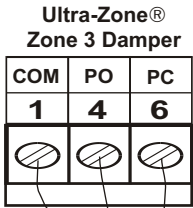

This 3 zone graphic reflects ALL zone damper wiring is routed thru the DAPC. This means that ALL zone dampers are capable of floating to control the static pressure.

However, two of the larger zones may be set to "Float with SP" and the third zone may be set to "Do Not Float", if that zone is smaller (low cfm) when compared to the other two zones (high cfm).

If all 3 zones are similar in size (sq ft) and designed for roughly the same cfm (heat loss/gain) then all 3 zones may be set to "Float with SP".

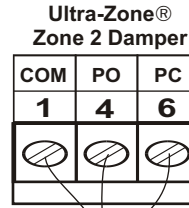

DAMPER DIAGRAM (3 zones)

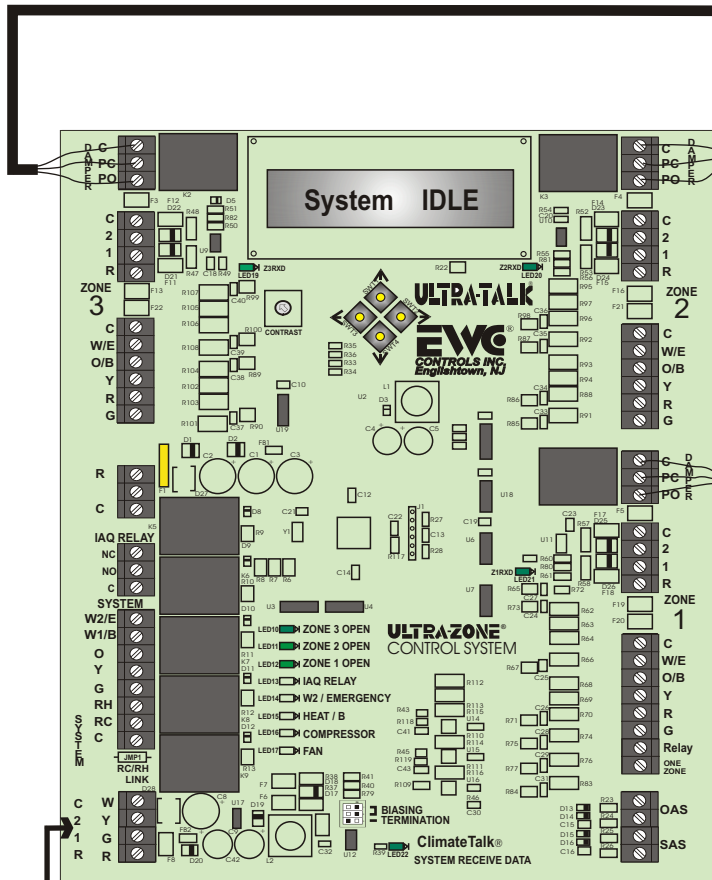
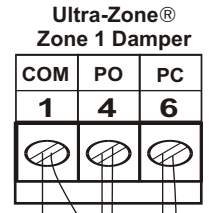
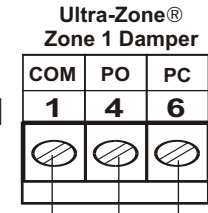

➔ **To FIT HVAC system**

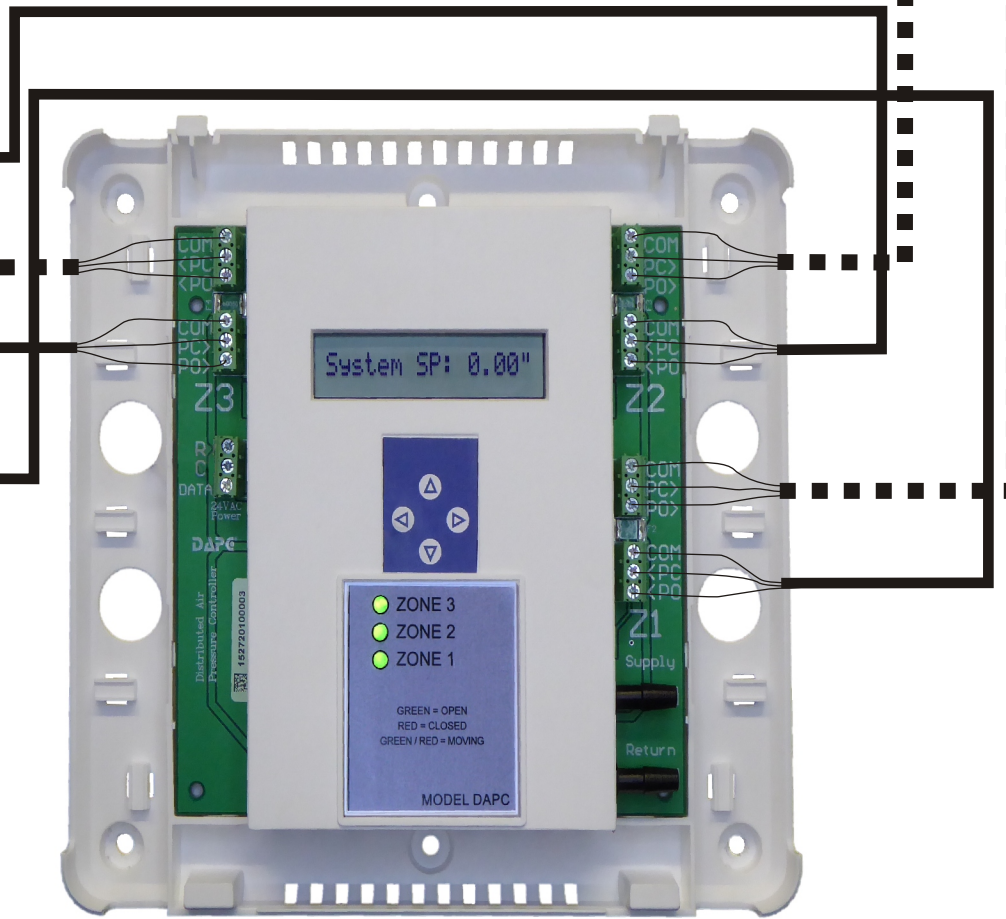

OTHER LOW VOLTAGE WIRING IS NOT SHOWN FOR CLARITY

Damper Cable Routing (Single Line)

This 3 zone graphic reflects that ONLY zone 1 & zone 2 damper wiring is routed thru the DAPC.

Zone 3 is a small zone (low cfm) when compared to zone 1 and zone 2 (high cfm).

This configuration is similar to Page 15, with the exception that zone 3 damper wiring was not physically routed thru the DAPC. Therefore, the DAPC cannot float zone 3, unless the damper wiring for zone 3 is re-routed thru the DAPC.

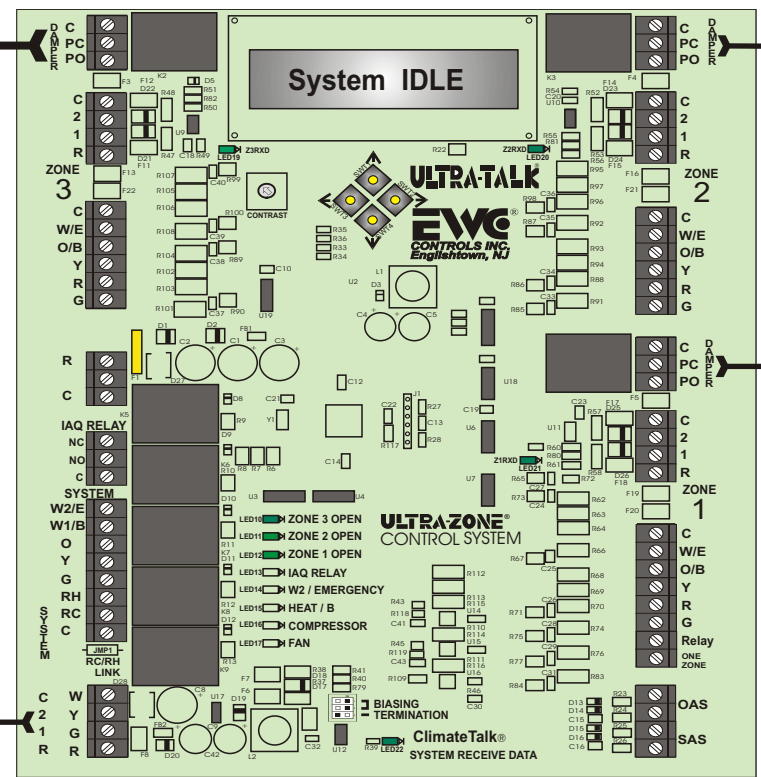
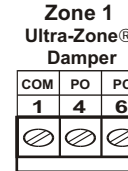
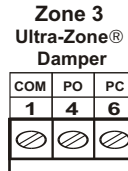
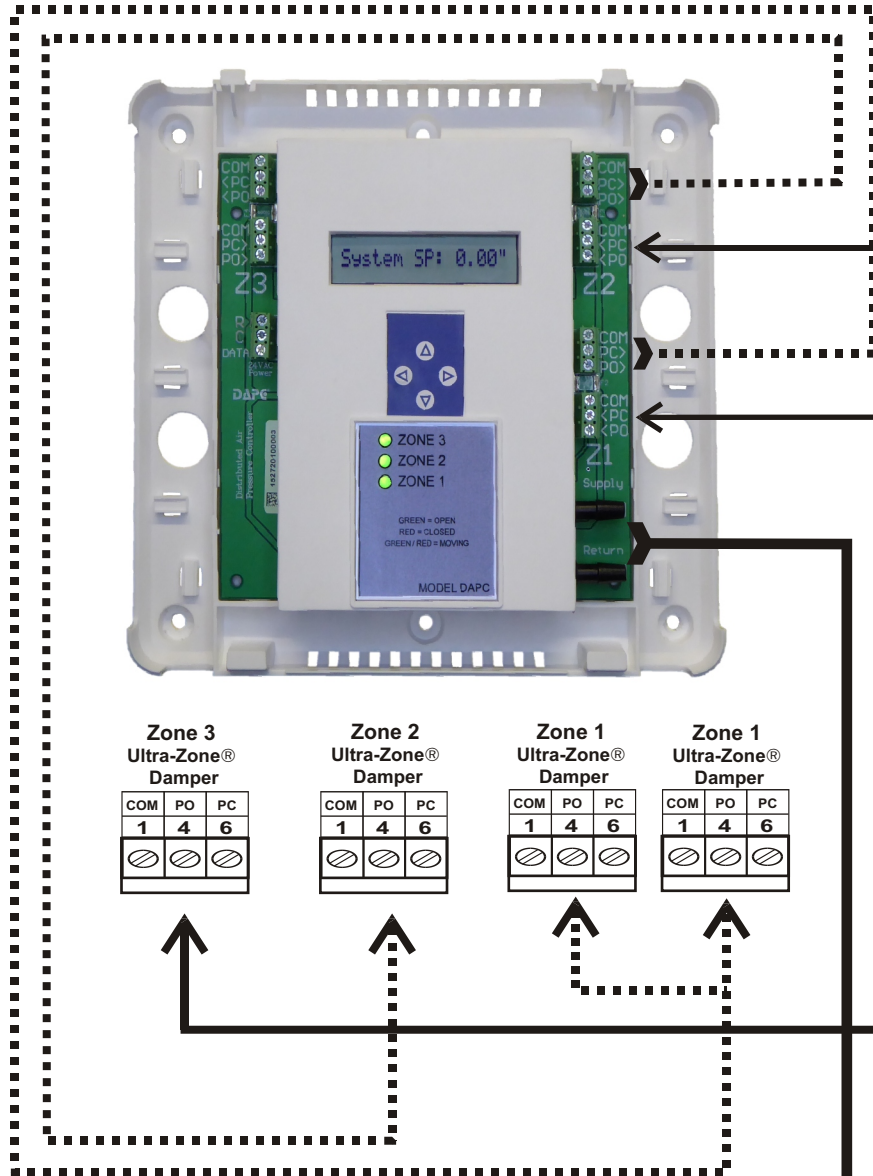

To Supply / Return Duct Pitot Tubes

To FIT HVAC system

DAMPER WIRING (5 zones)

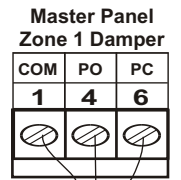
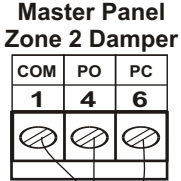
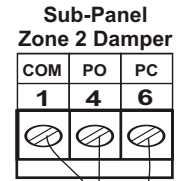
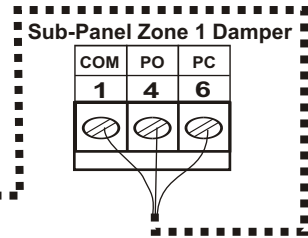
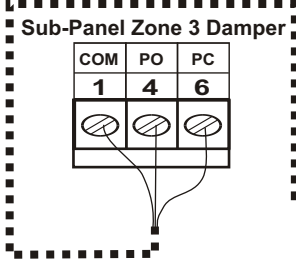
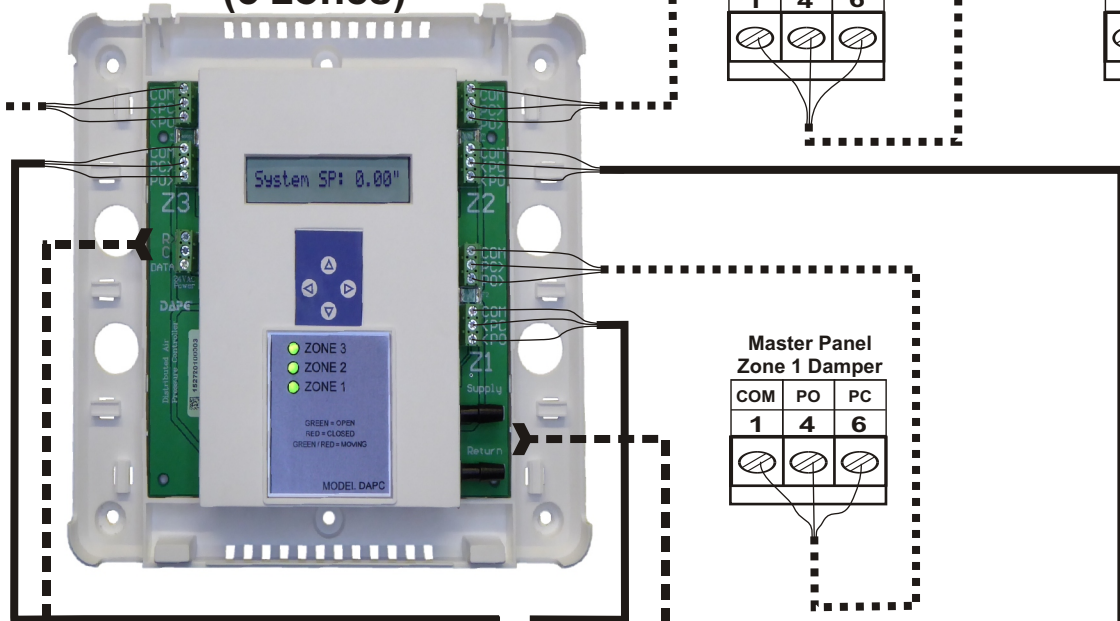

This "twinning" 5 zone graphic reflects three large zones routed thru the DAPC and two small zones bypassing the DAPC.

The two small zones are Zone 2 on the Master panel and Zone 2 on the Sub-Panel.

This configuration will achieve proper static pressure control by floating the 3 largest zone dampers, when only one or two zones demand airflow.

Other associated control wiring such as thermostats, HVAC system and/or ancillary devices are not shown for clarity.

To ZC 24vac supply

To Pitot Tubes

Twinning Circuit

To FIT HVAC system

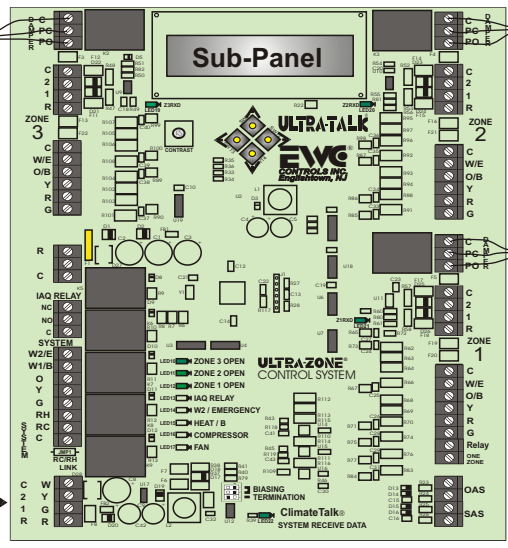
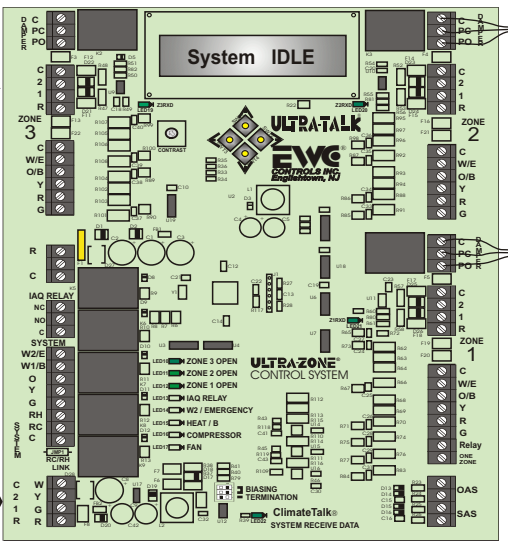

3 ZONE SYSTEM COMPLETE CONFIGURATION

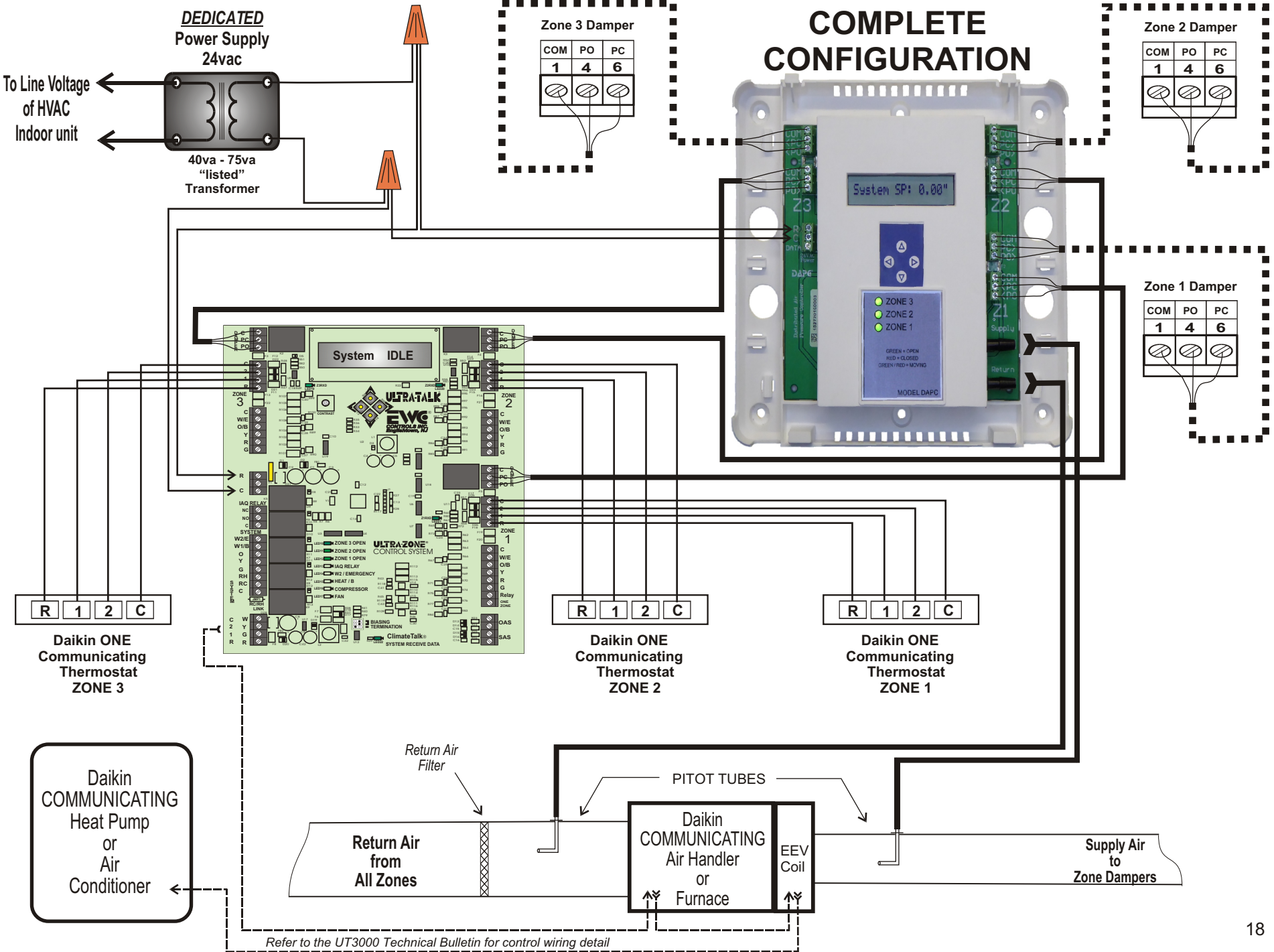

TROUBLESHOOTING

SYMPTOM	SOLUTIONS
DAPC will not power up. No LCD display and Zone LED's do not illuminate.	Check 24vac transformer power supply input (<i>R & C terminals</i>) with a voltmeter. If 24vac power is absent determine root cause and repair. The DAPC MUST be powered from the same 24vac source as the zone controller. This means the zone controller must be powered from a dedicated 24vac (40va - 75va) transformer.
DAPC will not operate(float) any zone dampers at all. DAPC will not operate (float) damper(s) on a single zone. <i>24vac power is not present at one or more damper motor terminal blocks.</i>	System static pressure is lower than DAPC set-point. Damper close commands are not detected or incompatible zone dampers are installed. Zone damper input or output wiring is incorrect or faulty. F2, F3 or F4 poly-fuses have tripped indicating shorted damper wires. Disconnect damper "output" wiring from the DAPC and the damper(s). Perform continuity test on all damper wiring for open & shorted wires. The DAPC is not powered from the same 24vac transformer that powers the new or existing Zone Controller. See page 13.
Excessive airflow into inactive (floating) zones. Zone dampers float but do not maintain synch with the DAPC. System airflow is loud & noisy.	Duct work is severely under-sized. The active zone(s) are taking too long to satisfy. Small (low CFM) zone(s) are set to "Float with SP" in addition to (or rather than) the highest CFM zone(s). Zone damper wiring is incorrect or faulty. Incompatible zone dampers are installed. Active and/or Inactive zone damper(s) are faulty and will not operate. Selected zone damper Stroke Time (<i>35second or 15second</i>) is incorrect for one or more zones. Selected zone Damper Type (<i>round, square, linear</i>) is incorrect for one or more zones. Perform a commissioning test via the DAPC, in order to confirm proper incremental damper movement. See page 8.

SYMPTOM/PROBLEM	SOLUTIONS: DETECTING 24vac SHORTED WIRING
No 24vac power on damper wires coming from the zone controller.	If there is a short in a damper "input" circuit between the DAPC and the Zone Controller, the zone controller will interrupt to protect that zone. Ohm out that wire set and repair as necessary.
No 24vac power on damper wires going to the dampers, from the DAPC.	If there is a short in a damper "output" circuit between the DAPC and the Damper Motors, the DAPC will interrupt to protect that zone. Ohm out that wire set and repair as necessary.
<i>140mA & 500mA circuit breakers protect the DAPC Data input circuit and Damper output circuits, reacting to short circuits in the field wiring.</i>	Disconnect the wiring from the "C/PC/PO" output terminals on the DAPC damper motor terminal blocks. Also disconnect those same wires from the damper motor. The 500mA breaker should reset and 24vac power can then be measured. Ohm out the PO & PC field wires for continuity to the 24vac common wire and to earth ground. If shorts are present, repair/replace wiring as necessary.

Detecting 24v shorts to common or shorts to earth ground

To reset an on-board breaker, locate the short by removing each hot wire connected to each terminal block, one wire at a time. When the shorted wire is removed, the breaker will reset and 24vac power is restored. Now you must repair or replace the shorted wire. If one or more 500mA breakers trip, only the device(s) connected to that block will be affected. Remove each hot wire connected to that block until the voltage is restored. Find and repair the shorted wires or device before re-connecting the wires. Find and repair the short using the methods described above.

TECHNICAL SUPPORT

EWC® Controls provides superior toll free Troubleshooting Support for the DAPC when you are on the job site!

Call 1-800-446-3110 Monday - Friday 8am to 5pm EST. Otherwise call 1-732-446-3110 for information on the DAPC and other ULTRA-ZONE® products. Visit our web site to [download this Technical Bulletin](#) and other related information at www.ewcccontrols.com

When calling for Technical Support from the job-site, please have a good quality multi-meter, pocket screwdriver, and wire cutters/strippers on hand.

PAY ATTENTION TO YOUR WIRING & MAINTAIN POLARITY!

Some zone controllers have damper output terminals *C, PC & PO*.

Some zone controllers have damper output terminals *M1, M4 & M6*.

The DAPC has Input and Output damper terminals *Com, PC & PO*.

Some damper motors have terminals 1, 4 & 6 or *C, PO, PC*.

These damper terminals are all the same and perform the same function, but they may not be in the same sequence, from the zone control to the DAPC or from the DAPC to the damper motor. So pay attention to your wiring!

M1 = 1 = C or COM (24v common)

M4 = 4 or PO (24v power to Open)

M6 = 6 or PC (24v power to Close)

The sequence (*Com, PC, PO*) on the DAPC, may not match the sequence on the Zone Controller (*M1, M4, M6*) or match the sequence on the Damper Motor (*Com, PO, PC*).

Pay attention to your wiring & maintain polarity!

Job Notes:

Log onto <https://ewcccontrols.com/warranty/> to register your DAPC for warranty!

If you have questions pertaining to this product, contact EWC Technical Support at 800-446-3110. You can also Email us at tech@ewcccontrols.com.