

# 2015 TOTALINE<sup>®</sup> HVAC/R PARTS CATALOG

---

# WHAT ARE YOU WORKING ON TODAY?<sup>™</sup>



**Universal HVAC/R  
Parts and Supplies**

# Table of Contents

## Categorized Listing

<b>Electrical</b>	<b>1</b>
TOTALINE® CAPACITORS	2
General Information	2
Oval Motor Run Capacitor - Dual	3
Oval Motor Run Capacitor - Single	4
Round Motor Run Capacitor - Dual	5
Round Motor Run Capacitor - Single	5
TOTALINE® CAPACITOR ACCESSORIES	6
Start Kit	6
Bracket, End Cap, Boot	6
Wire Kit	6
Start Thermister	6
Strap	6
TOTALINE® RELAYS	7
Relay Application Data - Control Relays	7
Fan & Power Relays	8
Two Pole Fan Relays	8
Heavy Duty Fan Relays	8
Start Relays	8
Fan Control Center Relays	8
TOTALINE® CONTACTORS	9
General Information	9
TOTALINE® CONTROL TRANSFORMERS	10
General Information	10
TOTALINE® PROTECTION CONTROLS	10
Head Pressure Control With Optional Heat Pump Override	10
Head Pressure Control With Optional Heat Pump Override-line Voltage	11
Monitors	12
Defrost Control	13
Timers And Delays	14
Timers And Delays	16
Start Kits	16
FUSES AND ACCESSORIES	17
Fuses	17
Littelfuse Fuse Accessories	20
TOTALINE® WIRING ACCESSORIES	22
Terminal Kits	22
Cable Ties - Natural Color	22
Cable Ties - Black	23
Other Wiring Accessories	24
Shrink Tubing	25
Tew Thermoplastic Equipment Wire	26
Terminals And Connectors	27
Kits And Application Tools	31

---

## Electrical Components

The following section contains information on common electrical components, including:

- Totaline® Capacitors
- Totaline® Capacitor and Accessories
- Totaline® Relays
- Totaline® Contactors
- Totaline® Control Transformers
- Totaline® Protection Controls
- Fuses and Accessories
- Totaline® Wiring Accessories

# TOTALINE® CAPACITORS

## General Information



This capacitor series is designed specifically for the motor run applications where the capacitors are used in conjunction with permanent split capacitor type motors. They may be used on either 50 or 60-Hertz systems but should not be used at higher frequencies or in applications where higher frequency harmonics are present. For those types of applications the General Purpose AC Capacitors should be used.

### Features And Benefits

- Reliability tested to meet 60,000 service hours, per United Technologies application parameters
- High grade metallized Polypropylene Film (5 to 12 microns thick)
- RoHS Compliant
- UL Approved with Pressure Sensitive interrupter of 1000 AFC
- Performance tested per United Technologies reliability requirements for capacitance ratings, power factor, dissipation factor and high voltage testing

### Product Range

- Capacitance: 5uF to 80uF
- Tolerance: +/- 6%
- Voltage: 370 to 440 VAC
- Op Temp: -29o to +68o C

**Note:** Distributors that have historically stocked 440 volt and 370 volt capacitors round and / or oval designs can standardize inventory to use a 440 volt capacitors as replacement for a 370 volt capacitor provided the capacitance in (Mfd.) stays exactly the same.

**Warning Note:** Under no circumstances are we recommending usage of a 370 volt capacitor to replace a 440 volt capacitor. Also our capacitor straps are designed to secure and ground the capacitor, so we don't recommend mixing oval or round capacitor designs.

# TOTALINE® CAPACITORS

## Oval Motor Run Capacitor - Dual

Part Number	Cap Grp	Voltage (VAC)	Capacitance (µF ) MFD	Dia	Height
P291-0553	Oval Dual	370	5/5	1.8	2.6
P291-0773	Oval Dual	370	7.5/7.5	1.8	3.1
P291-1013	Oval Dual	370	10/10	1.8	3.3
P291-1513	Oval Dual	370	15/10	1.8	3.3
P291-1543	Oval Dual	370	15/4	1.8	3.1
P291-1554	Oval Dual	440	15/5	1.8	3.1
P291-1573	Oval Dual	370	15/7.5	1.8	3.3
P291-2053	Oval Dual	370	20/5	1.8	3.3
P291-2054	Oval Dual	440	20/5	1.8	3.5
P291-2074	Oval Dual	440	20/7.5	1.8	3.9
P291-2513	Oval Dual	370	25/10	1.8	3.7
P291-2543	Oval Dual	370	25/4	1.8	3.5
P291-2553	Oval Dual	370	25/5	1.8	3.5
P291-2554	Oval Dual	440	25/5	1.8	3.9
P291-2573	Oval Dual	370	25/7.5	1.8	3.5
P291-2574	Oval Dual	440	25/7.5	1.9	3.7
P291-3013	Oval Dual	370	30/10	1.9	3.5
P291-3014	Oval Dual	440	30/10	1.9	4.1
P291-3053	Oval Dual	370	30/5	1.8	3.7
P291-3054	Oval Dual	440	30/5	1.9	4.1
P291-3073	Oval Dual	370	30/7.5	1.8	3.7
P291-3074	Oval Dual	440	30/7.5	1.9	4.1
P291-3514	Oval Dual	440	35/10	1.9	4.5
P291-3523	Oval Dual	370	35/12.5	1.9	3.7
P291-3543	Oval Dual	370	35/4	1.9	3.7
P291-3553	Oval Dual	370	35/5	1.9	3.7
P291-3554	Oval Dual	440	35/5	1.9	4.5
P291-3554S	Oval Dual	440	35/5	1.8	4.9
P291-3573	Oval Dual	370	35/7.5	1.9	3.7
P291-3574	Oval Dual	440	35/7.5	1.9	4.5
P291-4014	Oval Dual	440	40/10	1.9	4.7
P291-4053	Oval Dual	370	40/5	1.9	4.1
P291-4053S	Oval Dual	370	40/5	1.9	4.3
P291-4054	Oval Dual	440	40/5	1.9	4.5
P291-4073	Oval Dual	370	40/7.5	1.9	4.1
P291-4074	Oval Dual	440	40/7.5	1.9	4.7
P291-4513	Oval Dual	370	45/10	1.9	4.3
P291-4553	Oval Dual	370	45/5	1.9	4.3
P291-4554	Oval Dual	440	45/5	1.9	4.7
P291-4554S	Oval Dual	440	45/5	1.9	5.5
P291-4573	Oval Dual	370	45/7.5	1.9	4.3
P291-4574	Oval Dual	440	45/7.5	1.9	4.9
P291-5014	Oval Dual	440	50/10	1.9	5.1
P291-5053	Oval Dual	370	50/5	1.9	4.7
P291-5054	Oval Dual	440	50/5	1.9	4.9
P291-5074	Oval Dual	440	50/7.5	1.9	4.9
P291-5513	Oval Dual	370	55/10	1.9	5.3
P291-5553	Oval Dual	370	55/5	1.9	5.3
P291-5554	Oval Dual	440	55/5	1.9	5.3
P291-5574	Oval Dual	440	55/7.5	1.9	5.3
P291-6013	Oval Dual	370	60/10	1.9	5.5
P291-6014	Oval Dual	440	60/10	1.9	5.5

P291-6053	Oval Dual	370	60/5	1.9	5.3
<del>P291-7053</del>	<del>Oval Dual</del>	<del>370</del>	<del>70/5</del>	<del>1.9</del>	<del>5.7</del>
P291-8013	Oval Dual	370	80/10	1.9	6.3
P291-8053	Oval Dual	370	80/5	1.9	6.3
P291-8054	Oval Dual	440	80/5	1.9	6.3
P291-8073	Oval Dual	370	80/7.5	1.9	6.3

# TOTALINE® CAPACITORS

## Oval Motor Run Capacitor - Single

Electrical

Part Number	Cap Grp	Voltage (VAC)	Capacitance (µF ) MFD	Dia	Height
P291-0203	Oval Single	370	2	1.2	2.6
P291-0303	Oval Single	370	3	1.2	2.6
P291-0304	Oval Single	440	3	1.2	2.6
P291-0403	Oval Single	370	4	1.2	2.8
P291-0404	Oval Single	440	4	1.2	2.8
P291-0503	Oval Single	370	5	1.2	2.8
P291-0504	Oval Single	440	5	1.2	3.1
P291-0603	Oval Single	370	6	1.2	3.1
P291-0604	Oval Single	440	6	1.2	3.1
P291-0753	Oval Single	370	7.5	1.2	3.5
P291-0754	Oval Single	440	7.5	1.2	3.5
P291-1003	Oval Single	370	10	1.2	3.5
P291-1004	Oval Single	440	10	1.2	4.1
P291-1253	Oval Single	370	12.5	1.2	3.5
P291-1254	Oval Single	440	12.5	1.2	4.5
P291-1503	Oval Single	370	15	1.2	3.7
P291-1504	Oval Single	440	15	1.2	4.5
P291-1753	Oval Single	370	17.5	1.2	4.1
P291-1754	Oval Single	440	17.5	1.8	3.1
P291-2003	Oval Single	370	20	1.2	4.3
P291-2004	Oval Single	440	20	1.8	3.1
P291-2503	Oval Single	370	25	1.8	3.1
P291-2503S	Oval Single	370	25	1.2	4.9
P291-2504	Oval Single	440	25	1.8	3.5
P291-3003	Oval Single	370	30	1.8	3.3
P291-3003S	Oval Single	370	30	1.2	5.3
P291-3004	Oval Single	440	30	1.8	3.9
P291-3503	Oval Single	370	35	1.8	3.7
P291-3504	Oval Single	440	35	1.8	4.3
P291-4003	Oval Single	370	40	1.8	3.9
P291-4004	Oval Single	440	40	1.9	3.5
P291-4503	Oval Single	370	45	1.9	3.5
P291-4504	Oval Single	440	45	1.9	3.7
P291-5003	Oval Single	370	50	1.9	3.5
P291-5004	Oval Single	440	50	1.9	3.9
P291-5503	Oval Single	370	55	1.9	3.5
P291-5504	Oval Single	440	55	1.9	4.1
P291-6003	Oval Single	370	60	1.9	3.7
P291-6004	Oval Single	440	60	1.9	4.3
P291-6503	Oval Single	370	65	1.9	3.7
P291-6504	Oval Single	440	65	1.9	4.5
P291-7003	Oval Single	370	70	1.9	3.9
P291-7004	Oval Single	440	70	1.9	4.7
P291-8003	Oval Single	370	80	1.9	4.3
P291-8004	Oval Single	440	80	1.9	4.9

# TOTALINE® CAPACITORS

## Round Motor Run Capacitor - Dual

Part Number	Cap Grp	Voltage (VAC)	Capacitance (µF ) MFD	Dia	Height
P291-1553RS	Round Dual	370	15/5	2.0	3.5
P291-1554RS	Round Dual	440	15/5	2.0	4.3
P291-2053R	Round Dual	370	20/5	2.0	3.7
P291-2054RS	Round Dual	440	20/5	2.0	4.6
P291-2513R	Round Dual	370	25/10	2.5	4.3
P291-2534R	Round Dual	440	25/3	2.0	4.4
P291-2553RS	Round Dual	370	25/5	2.0	3.9
P291-2554R	Round Dual	440	25/5	2.5	4.3
P291-2554RS	Round Dual	440	25/5	2.0	4.8
P291-2573R	Round Dual	370	25/7.5	2.5	3.7
P291-2573RS	Round Dual	370	25/7.5	2.0	4.3
P291-3013RS	Round Dual	370	30/10	2.0	4.4
P291-3033R	Round Dual	370	30/3	2.0	4.1
P291-3053RS	Round Dual	370	30/5	2.0	4.1
P291-3054R	Round Dual	440	30/5	2.5	4.3
P291-3054RS	Round Dual	440	30/7.5	2.0	5.2
P291-3073R	Round Dual	370	30/7.5	2.5	3.7
P291-3073RS	Round Dual	370	35/10	2.0	4.4
P291-3513RS	Round Dual	370	35/3	2.0	4.8
P291-3533R	Round Dual	370	35/3	2.0	4.4
P291-3534R	Round Dual	440	35/5	2.5	4.3
P291-3553RS	Round Dual	370	35/5	2.0	4.4
P291-3554RS	Round Dual	440	35/7.5	2.0	5.2
P291-3573R	Round Dual	370	35/7.5	2.5	3.7
P291-3573RS	Round Dual	370	35/7.5	2.0	4.8
P291-3574RS	Round Dual	440	35/7.5	2.0	5.2
P291-4033R	Round Dual	370	40/3	2.0	4.6
P291-4034R	Round Dual	440	40/3	2.5	4.3
P291-4053RS	Round Dual	370	40/5	2.0	4.6
P291-4054RS	Round Dual	440	40/5	2.0	5.8
P291-4073RS	Round Dual	370	40/7.5	2.0	5.0
P291-4074RS	Round Dual	440	40/7.5	2.0	5.6
P291-4513RS	Round Dual	370	45/10	2.0	5.2
P291-4533R	Round Dual	370	45/3	2.0	4.8
P291-4553RS	Round Dual	370	45/5	2.0	4.8
P291-4554RS	Round Dual	440	45/5	2.5	4.4
P291-4573RS	Round Dual	370	45/7.5	2.0	5.2
P291-4574RS	Round Dual	440	45/7.5	2.5	4.8
P291-5053RS	Round Dual	370	50/5	2.0	5.2
P291-5054RS	Round Dual	440	50/5	2.5	4.8
P291-5073RS	Round Dual	370	50/7.5	2.0	5.4
P291-5513R	Round Dual	370	55/10	2.5	4.6
P291-5514RS	Round Dual	440	55/10	2.5	5.2
P291-5553RS	Round Dual	370	55/5	2.5	4.3
P291-5554RS	Round Dual	440	55/5	2.5	4.4
P291-5573RS	Round Dual	370	55/7.5	2.5	4.3
P291-5574RS	Round Dual	440	55/7.5	2.5	5.2
P291-6013R	Round Dual	370	60/10	2.5	4.8
P291-6053RS	Round Dual	370	60/5	2.5	4.6
P291-6054R	Round Dual	440	60/5	2.5	5.2
P291-6073RS	Round Dual	370	60/7.5	2.5	4.6
P291-6074R	Round Dual	440	60/7.5	2.5	5.2

P291-7013RS	Round Dual	370	70/10	2.5	5.2
P291-7053RS	Round Dual	370	70/5	2.5	4.8
P291-7054R	Round Dual	440	70/5	2.5	5.4
P291-7073RS	Round Dual	370	70/7.5	2.5	4.8
P291-7554R	Round Dual	440	75/5	2.5	5.6
P291-8013RS	Round Dual	370	80/10	2.5	5.4
P291-8053RS	Round Dual	370	80/5	2.5	5.2
P291-8054RS	Round Dual	440	80/5	2.5	5.8
P291-8073RS	Round Dual	370	80/7.5	2.5	5.2

## Round Motor Run Capacitor - Single

Part Number	Cap Grp	Voltage (VAC)	Capacitance (µF ) MFD	Dia	Height
P291-0503R	Round Single	370	5	1.8	2.9
P291-0753R	Round Single	370	7.5	1.8	2.9
P291-1003R	Round Single	370	10	1.8	2.9
P291-1004R	Round Single	440	10	1.8	2.9
P291-1253R	Round Single	370	12.5	1.8	2.9
P291-1503R	Round Single	370	15	1.8	3.3
P291-1504R	Round Single	440	15	1.8	3.3
P291-2003R	Round Single	370	20	1.8	3.5
P291-2004R	Round Single	440	20	1.8	3.5
P291-2503R	Round Single	370	25	1.8	3.5
P291-2503RS	Round Single	370	25	1.8	3.5
P291-2504R	Round Single	440	25	1.8	4.1
P291-3003R	Round Single	370	30	1.8	4.3
P291-3004R	Round Single	440	30	1.8	4.3
P291-3504R	Round Single	440	35	1.8	4.6
P291-4003R	Round Single	370	40	2.0	3.9
P291-4004R	Round Single	440	40	1.8	5.2
P291-4503R	Round Single	370	45	2.5	4.3
P291-4504RS	Round Single	440	45	2.0	4.8
P291-5003R	Round Single	370	50	2.5	4.3
P291-5004R	Round Single	440	50	2.5	4.3
P291-5504R	Round Single	440	55	2.5	4.4
P291-6004R	Round Single	440	60	2.5	4.4
P291-6503R	Round Single	370	65	2.5	4.3
P291-8003R	Round Single	370	80	2.5	5.2

# TOTALINE® CAPACITOR ACCESSORIES

## Start Kit

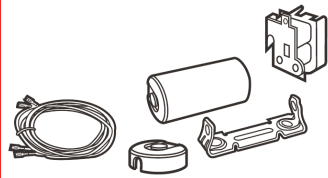

Totaline Start Kits are for use with PSC compressors requiring additional starting torque. Totaline Start Kits are available for the most popular Copeland, Tecumseh, Bristol, and Carlyle compressors.

**The Kit contains the following:**

- Start Capacitor
- Start Relay
- Wire Kit
- (1) Black Wire 54" Long
- (1) Brown Wire 16" Long
- (1) Blue Wire 38" Long
- (1) Brown Wire 30" Long
- End Cap
- Bracket
- Instruction Sheet

Part Number	Start Capacitor		Contact Rating	Start Relay		
	Mfd Range	Volts		Max Oper Volts	Pickup Volts	Dropout Volts
P296-0007	21-25	330	50 AMP	336	162-175	55-115
P296-0006	43-53	320	35 AMP	336	162-175	40-90
P296-0001	43-53	320	50 AMP	395	180-195	40-105
P296-0012	72-88	330	35 AMP	336	162-175	40-90
P296-0005	88-108	330	35 AMP	336	162-175	40-90
P296-0002	88-108	330	50 AMP	420	195-224	60-123
P296-0004	88-108	330	50 AMP	395	180-195	40-105
P296-0009	88-108	330	50 AMP	336	162-175	55-115
P296-0010	108-130	330	50 AMP	420	195-224	70-140
P296-0003	135-155	320	50 AMP	420	195-224	60-123
P296-0008	145-175	330	50 AMP	395	180-195	40-105
P296-0011	189-227	330	50 AMP	420	262-290	60-121

## Bracket, End Cap, Boot

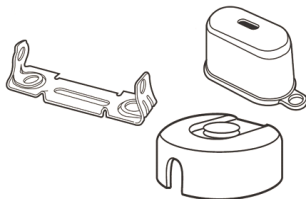

Part Number	Part Name	Use With Capacitor
P281-0017	Start Capacitor Bracket	3-3/8" Long
P281-0016	Start Capacitor Bracket	4-3/8" Long
P281-0011	Capacitor End Cap	1-13/16" Diameter
P281-0012	Capacitor End Cap	2-1/16" Diameter
P281-0013	Capacitor End Cap	2-9/16" Diameter
P281-0002	Terminal Boot	Single Oval Top Outlet
P281-0003	Terminal Boot	Single Oval (2) Side Outlets
P281-0006	Terminal Boot	Single Round
P281-0004	Terminal Boot	Dual Oval

## Wire Kit

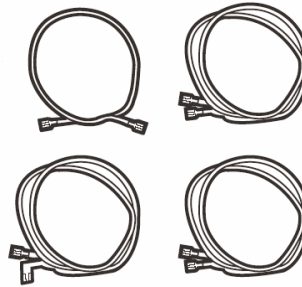

An assortment of wires to be used to connect a Start Relay and Start Capacitor to a unit for hard start capability.

Part Number	Description
P421-4012	(1) Black Wire 44 IN. Long, (1) Blue Wire 22 IN. Long, (1) Black Wire 14 IN. Long, (1) Yellow Wire 29 IN. Long
P421-4013	(1) Black Wire 54 IN. Long, (1) Brown Wire 16 IN. Long, (1) Blue Wire 38 IN. Long, (1) Brown Wire 30 IN. Long

## Start Thermistor

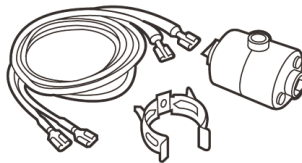

This 25 ohm PTC device provides additional starting torque for compressors. Connects in parallel to run capacitor.

Part Number	Part Name
P421-4006	Start Thermistor

## Strap

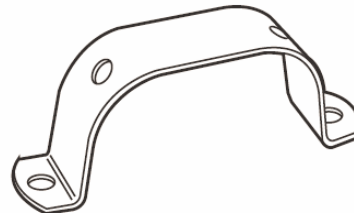

Part Number	Part Name	Use With Capacitor
P281-0031	Mounting Strap	1.21 x 2.06 Oval
P281-0021	Mounting Strap	1.81 x 2.81 Oval
P281-0028	Mounting Strap	1.87 x 3.56 Oval
P281-0025	Mounting Strap	15 Fit All



# TOTALINE® RELAYS

## Relay Application Data - Control Relays

The main function of any relay is switching electrical circuits. Selection depends on load characteristics which should be matched closely to the rating of the relay to avoid contact point deterioration. Relay ratings in amperes are listed in this brochure as inductive or resistive.

**Inductive Rating** - applies to switching of motors and coils for contactors and relays.

**Resistive Rating** - applies to switching of electric resistance heating elements. The relays shown on the following pages have been classified into two major categories, power rated relays for intermediate loads and pilot duty relays for low level switching.

**Pilot duty relays:** Contacts are made of a fine silver alloy and are shaped and sized for low level current switching. The fine silver alloy contact provides a very low surface resistance for the best possible contact life. Use on higher or intermediate loads would melt the relay points causing a welded contact.

**Power Rated Relays:** Contacts are generally made of silver cadmium oxide with a very high surface resistance. They are sized larger than pilot duty contacts to handle switching of intermediate loads during which a slight arc may occur. Due to being larger in size, they must operate with a lower unit pressure on the contacts and, for satisfactory performance, depend on the makebreak arc process to break down the resistance of deposits formed on the contacts. Use of this type relay to switch low level loads is not recommended by Carrier or its suppliers due to the lower contact pressure, the high surface resistance of the contacts and the absence of the slight arc during switching. A continuing build-up of deposits on contact points will cause a nonconductive surface and a failed relay. In some instances a power rated relay will fail to switch a pilot duty load on initial use. For reliable relay operation, it's advisable not to use a power rated relay for a pilot duty relay or vice versa.

### CONTACT ARRANGEMENT DIAGRAMS

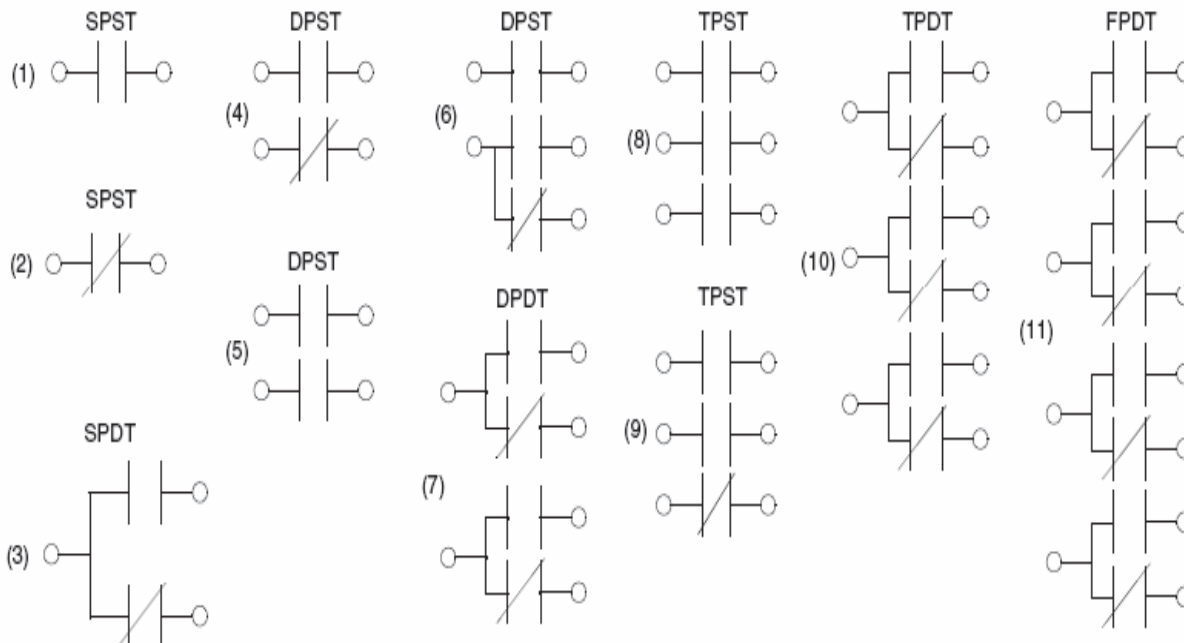

**DB** - Indicates contacts are Double Break type in which stationary contacts are connected by a bridging bar. Two examples of a double break arrangement are shown with contacts #1 and #2 stationary. Both are SPST, normally closed, double break arrangements.

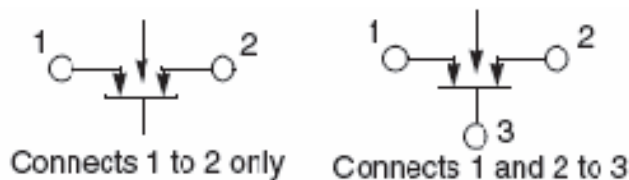

# TOTALINE® RELAYS

## Fan & Power Relays

### General Purpose Relay

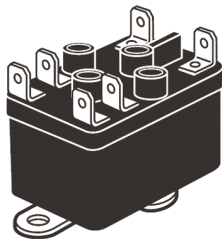

Dependable, low cost solution for air conditioning and heating switching.  
**Insulating Material** - Constructed of UL recognized Class B insulating material

**Temperature Range** - -40° to 150° Fahrenheit  
**Single Pole Fan Relays- Similar To Type 84 Fan Relays**

- Fan control
- Appliances
- Business Machines
- Photoelectric control and general purpose switching

Part Number	Contact Rating 125/250 Vac	Description
P283-0290	8 Amps (Ind.) 16 Amps (Res.)	SPST, 24 V Coil
P283-0291	Continuous	SPST, 110 V/120 V Coil
P283-0292	25 Amps Inrush	SPST, 208/240 V Coil
P283-0293	8 Amps (ind.) 8 Amps (res.)	SPDT, 24 V Coil
P283-0294	Continuous	SPDT, 110/120 V Coil
P283-0295	18 Amp Inrush	SPDT, 208/240 V Coil

### Two Pole Fan Relays

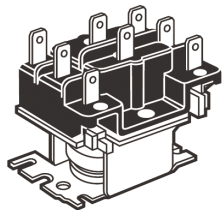

- Features:**
- Vending machines
  - Appliances
  - Safety control
  - Fan control
  - Heating
  - Air conditioning and general purpose switching

Part Number	Terminals		Description
	1-2-3	4-5-6	
P283-0340	Power	Power	24 V Coil
P283-0341	Power	Power	110 V/120 V Coil
P283-0342	Power	Power	208/240 V Coil
P283-0343	Power	Pilot	24 V Coil
P283-0344	Power	Pilot	110 V/120 V Coil
P283-0345	Power	Pilot	208/240 V Coil
P283-0346	Pilot	Pilot	24 V Coil
P283-0347	Pilot	Pilot	110 V/120 V Coil
P283-0348	Pilot	Pilot	208/240 V Coil

### Heavy Duty Fan Relays

Part Number	Contact Arrangement	Description
P283-0360	SPDT - NO	24 V Coil
P283-0370	SPDT - NO	24 V Coil
P283-0380	SPNO - SPNC	24 V Coil

## Start Relays

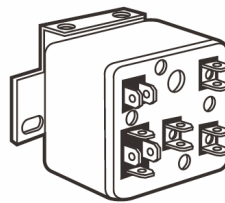

- Features:**
- Single pole, NC relays
  - Totally Enclosed
  - Contacts rated for a max. arc rupturing capacity at 600 vac and under.
  - 1/4" Quick connects
  - G.E. 3arr3 type & rbm 128000 type
  - 50/60 hz

Part Number	Contact Rating	Volts		
		Pickup	Dropout	Max Oper
P283-9924	35 Amp	162 -175	40 - 90	336
P283-9928	15 Amp	180 -195	40 - 105	375
P283-9926	25 Amp	111 -124	20 - 45	170
P283-9916	50 Amp	140 -152	33 - 77	253
P283-9917	50 Amp	162 -175	55 - 115	336
P283-9919	50 Amp	171 -184	40 - 90	336
P283-9921	50 Amp	180 -193	55 - 115	336
P283-9923	50 Amp	180 -195	40 - 105	395
P283-9915	50 Amp	195 -224	60 - 123	420
P283-9913	50 Amp	204 -233	60 - 121	420
P283-9922	50 Amp	223 -254	60 - 140	395
P283-9918	50 Amp	239 -268	60 - 135	495
P283-9914	50 Amp	262 -290	60 - 121	420
P283-9912	50 Amp	277 -305	75 - 150	495
P283-9911	50 Amp	295 -324	60 - 135	495

## Fan Control Center Relays

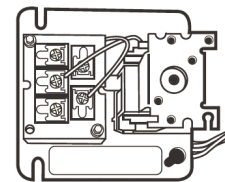

- Features:**
- 40 VA transformer
  - 24 volt secondary
  - Fits standard 4" Junction box.
  - Self-contained unit requires no additional closure.
  - Unit imprinted with wiring diagram
- Resistive contact rating:** 15a @ 277v  
**Relay coil volts:** 24  
**Inductive contact rating:** 3/4 h.p., 12a @ 120v; 3/4 h.p., 6a @ 240v

Part Number	Contact Arrangement	Transformer Primary	Plug-In Relay
P211-4010	DPDT	120/208/240	Semi-Enclosed
P211-4012	SPNO/SPNC	120	Semi-Enclosed
P211-4013	SPDT	120	Semi-Enclosed
P211-4014	SPST	120	Semi-Enclosed
P211-4015	SPDT	240	Semi-Enclosed
P211-4020	SPDT	120	Semi-Enclosed

# TOTALINE® CONTACTORS

## General Information

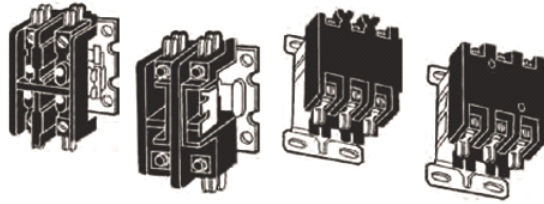

**Design Construction:** 50/60 Hz

Meets specifications for devices up to 600 VAC in accordance with U/L bulletin no. 508 "Industrial Control Equipment"

**Coil Insulation:** Standard Class B insulation.

**Terminals:**

Power #10-32 combination hex washer head screw, #10-32 combination hex head with pressure plate or box lug for 4 - 14 CU/AL wire.

**Quick Connects** - 2) 0.250 male push-ons available on each pole

**Coil** - (2) 0.250 male push-ons.

**Covers:** Standard on 40 amp and larger.

**Mounting** Panel mount and straight thru wiring.

**Application:** Designed for use in residential and commercial refrigeration, air conditioning, & heating applications.

**Also:**

- Water pump motors
- Blower or fans
- Compressor motors
- Resistance heating & other similar applications.

**UL / CSA recognized**

Part Number	Pole	Amps	Terminal Type	Coil Vac	Aux Contact	Length In	Height In
P282-0311	Single Pole	30	(Screw Term. & Shunt)	24	-	3.3 (8.38)	2.3 (5.84)
P282-0312	Single Pole	30	(Screw Term. & Shunt)	120	-	3.3 (8.38)	2.3 (5.84)
P282-0313	Single Pole	30	(Screw Term. & Shunt)	208/240	-	3.3 (8.38)	2.3 (5.84)
P282-0321	Two Pole	30	(Screw Terminals)	24	-	3.3 (8.38)	2.5 (6.35)
P282-0322	Two Pole	30	(Screw Terminals)	120	-	3.3 (8.38)	2.5 (6.35)
P282-0323	Two Pole	30	(Screw Terminals)	208/240	-	3.3 (8.38)	2.5 (6.35)
P282-0421	Two Pole	40	(Lug Terminals)	24	-	3.3 (8.38)	2.6 (6.60)
P282-0422	Two Pole	40	(Lug Terminals)	120	-	3.3 (8.38)	2.6 (6.60)
P282-0423	Two Pole	40	(Lug Terminals)	208/240	-	3.3 (8.38)	2.6 (6.60)-
P282-0331A	Three Pole	30	(Screw Terminals)	24	P282-X98220	3.4 (8.64)	2.6 (6.60)
P282-0332A	Three Pole	30	(Screw Terminals)	120	P282-X98220	3.4 (8.64)	2.6 (6.60)
P282-0333A	Three Pole	30	(Screw Terminals)	208/240	P282-X98220	3.4 (8.64)	2.6 (6.60)
P282-0431A	Three Pole	40	(Lug Terminals)	24	P282-X98220	3.4 (8.64)	2.6 (6.60)
P282-0432A	Three Pole	40	(Lug Terminals)	120	P282-X98220	3.4 (8.64)	2.6 (6.60)
P282-0433A	Three Pole	40	(Lug Terminals)	208/240	P282-X98220	3.4 (8.64)	2.6 (6.60)
P282-0531	Three Pole	50	(Lug Terminals)	24	P282-X34300	4.2 (10.67)	3.6 (9.14)
P282-0532	Three Pole	50	(Lug Terminals)	120	P282-X34300	4.2 (10.67)	3.6 (9.14)
P282-0533	Three Pole	50	(Lug Terminals)	208/240	P282-X34300	4.2 (10.67)	3.6 (9.14)
P282-0631	Three Pole	60	(Lug Terminals)	24	P282-X34300	4.2 (10.67)	3.6 (9.14)
P282-0632	Three Pole	60	(Lug Terminals)	120	P282-X34300	4.2 (10.67)	3.6 (9.14)
P282-0633	Three Pole	60	(Lug Terminals)	208/240	P282-X34300	4.2 (10.67)	3.6 (9.14)
P282-0731	Three Pole	75	(Lug Terminals)	24	P282-X34300	5	4.06
P282-0732	Three Pole	75	(Lug Terminals)	120	P282-X34300	5	4.06
P282-0733	Three Pole	75	(Lug Terminals)	208/240	P282-X34300	5	4.06
P282-0931	Three Pole	90	(Lug Terminals)	24	P282-X34300	5	4.06
P282-0932	Three Pole	90	(Lug Terminals)	120	P282-X34300	5	4.06
P282-0933	Three Pole	90	(Lug Terminals)	208/240	P282-X34300	5	4.06

# TOTALINE® CONTROL TRANSFORMERS

## General Information

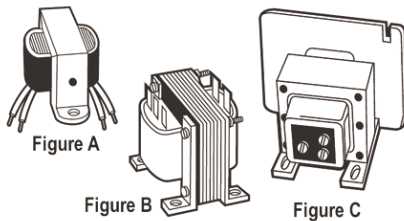

### Features:

- For low and medium VA requirements.
- Use to step down voltage for control circuits.
- Large selection of ratings and mounting.

Part Number	Fig	VA Rating	Primary Volts	Hz	Secondary Volts
P201-2201*	A	20	120	50/60	24
P201-3401*	A	40	120/208/240	50/60	24
P201-3402*	C	40	120/208/240	50/60	27/12/2.5
P201-3403*	C	40	120/208/240	50/60	24
P201-35150*	C	50	120/208/240	50/60	12/24
P201-4701	B	75	120/208/240/480	50/60	24
P201-4901	B	100	120/208/240/480	50/60	24

\*Supplied with 9 inch leads.

# TOTALINE® PROTECTION CONTROLS

## Head Pressure Control With Optional Heat Pump Override

**Head Pressure Controls** - Temperature sensitive fan motor control which regulates head pressure at low ambients by varying the air volume through the condenser. Its unique construction permits exceptionally quick response times to changes in liquid line temperatures.

### Application

Ideal for low ambient conditions found in:

- Supermarkets - Frozen Storage
- Computer rooms
- Temperature/ Humidity Sensitive Environments

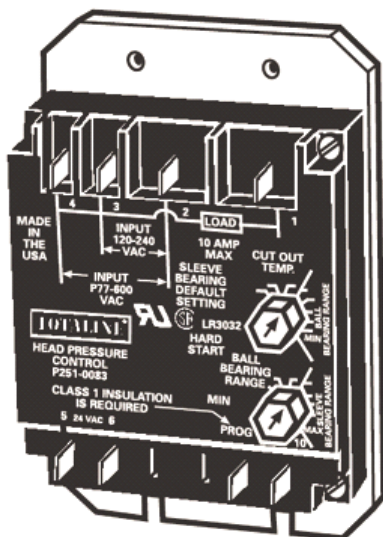

### FEATURES / APPLICATIONS

- Integral Heat Pump Bypass circuitry allows electronic bypass of speed control during heat pump operation.
- Eliminates overshoots common to on/off and pressure switch controls.
- Helps prevent evaporator freeze-ups, low pressure cut-outs and liquid-slugged compressors in low ambient conditions.
- One model covers 120-480 VAC
- Features: hard start, low temperature cutoff, high temperature bypass, isolated 24VAC supply.
- Controls up to 3 refrigerant circuits.
- Typical application: heat pumps.

### Specs

Input: Control: 18-30 VAC  
 Line Input: 120-480 VAC  
 Output: Triac  
 max: 10 amps  
 min: 100 ma  
 Output: Range: 120-480 VAC

### Replaces

Hoffman:  
 800/800A/800ASA/814-50  
 RANCO: E31 Series  
 Johnson Controls: P66  
 ACT: FM2000

Part Number	Volts	Description
P251-0083H	120-480 VAC	HPC w/optional,HP override

# TOTALINE® PROTECTION CONTROLS

## Head Pressure Control With Optional Heat Pump Override

### P251-0083C

Part Number	Volts	Description
P251-0083C	120-600 VAC	HPC (Canada)

## Head Pressure Control With Optional Heat Pump Override-line Voltage

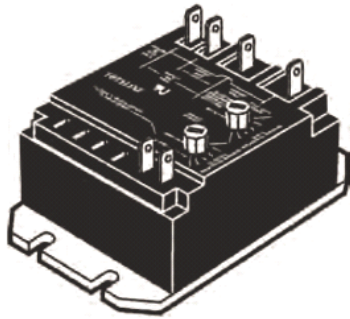

### P251-0094H, P251-0095H FEATURES / APPLICATIONS

- Built-in transformer eliminates cost, reduces installation time and simplifies wiring. Direct set up from line voltage.
- Helps prevent evaporator freezeups, low pressure cut-outs and liquid-slugged compressors in low ambient conditions.
- Features: hard start, low temperature cutoff, high temperature bypass, isolated 24 VAC supply is built into the control.
- Mechanical dimensions: 4.5" L x 3" W x 2" H.
- Ideal for heat pumps, line voltage, air conditioning and refrigeration

#### SPECS

Input: Frequency: 50/60 Hz  
 Power Consumption: 4 VA @ 24 VAC  
 Output Type: Triac  
 Output Voltage:  
 P251-0094H: 120 or 208/240 VAC  
 P251-0095H: 480 VAC  
 Output Current:  
 max: 10 amps  
 min: 100 ma

#### REPLACES

Hoffman:  
 800/800A/800ASA/814-50  
 RANCO: E31 Series  
 Johnson Controls: P66  
 Integral transformer reduces inventory

Part Number	Volts	Description
P251-0094H	120 or 240 VAC	Line Voltage,HPC w/Optional,HP Override
P251-0095H	480 VAC	Line Voltage,HPC w/Optional,HP Override

\*Supplied with 9 inch leads.

# TOTALINE® PROTECTION CONTROLS

## Monitors

### Three Phase Monitor

Electrical

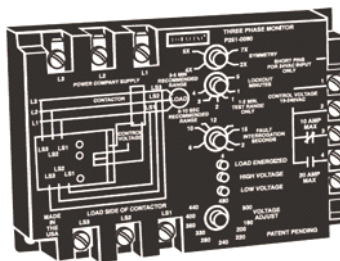

#### Features / Application

- Lower cost, full performance protection.
- Monitors front and back sides of system.
- 190-630 VAC operation.
- Bright LED indicators.
- Identifies front and back side faults.
- Knob-adjustable features.
- Reset-auto or manual (1 trial).
- Built-in short cycle protection.
- Monitors: voltage unbalance, high/low voltage, phase loss, reversal, incorrect sequencing, rapid short cycling.

#### Specs

##### Input:

Line Voltage: 190-630 VAC  
 Unbalance: adj. 2-25%  
 Control: 18-240 VAC  
 Frequency: 50/60 Hz

##### Output:

Relay, SPDT  
 n.o.: 10amps  
 n.c.: 6 amp

##### Replaces

Diversified: AC-2020 AC-301, 302  
 Motorsaver: 455  
 SSAC: QLM/QLV  
 TmeMark: 265  
 Wagoner: WPC-800  
 WATSCO: EAC-800, EAC-8000

Part Number	Volts	Control Voltage
P251-0090	190-630	18 - 240 VAC

### Three Phase Programmable Monitor

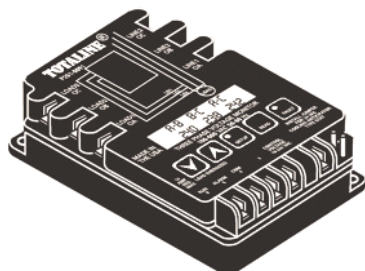

#### P251-0091 Features / Application

- Monitors front and back side of system.
- Programmable-25-fault memory storage.
- Independent high/low voltage settings for dual voltage compressor applications.
- Identifies front & back side faults.
- High temperature LCD to 167° F
- 190-630 VAC operation
- Simultaneous voltage display-no scrolling.
- Line voltage programmable.
- Reset-auto or manual.
- Non-volatile memory.
- Monitors: voltage unbalance, high/low voltage, phase loss, reversal, incorrect sequencing, rapid short cycling.
- Does not require control voltage for operation.

#### Specs

##### INPUT:

Voltage: 190-630VACI  
 Frequency: 50/60 Hz  
 Voltage Unbalance: adj. 2-25%  
 Control: 18-240 VAC

##### OUTPUT:

Relay, SPDT  
 n.o.: 10 amps  
 n.c.: 6 amps

##### Replaces

Diversified: AC-2020, AC-301, 302  
 Motorsaver: 455  
 SSAC: QLM / QLV  
 TimeMark: 265  
 Wagner: WPC-800  
 Watsco: EAC-800, EAC-8000

Part Number	Volts	Description
P251-0091	190-630	Programmable Three Phase 18-240VAC

# TOTALINE® PROTECTION CONTROLS

## Monitors

### Three Phase Line Voltage Monitor

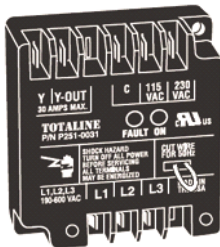
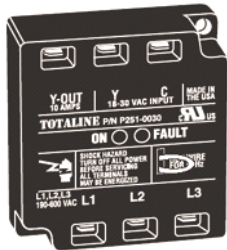

#### P251-0030 & P251-0031 Features / Application

- Low cost, single side 3-phase protection
- Bright LED indications for faults and loads energized
- Easy to install, no adjustments
- Wide operating range: 190-600 VAC
- Less than 1 second phase loss response
- Automatic reset from a fault condition
- Compact packaging: fits almost anywhere
- Rugged, epoxy-encapsulation for extreme conditions
- Works great with the Totaline P251-0091 for load side monitoring of part winding start and multiple compressor systems.

#### Specs

Line Voltage: 190-600 VAC  
 Frequency: 50/60 Hz  
 Control Voltage:  
 P251-0030: 18-30 VAC  
 P251-0031: 115- 230 VAC

#### Output:

Relay: SPST  
 P251-0030: N.O. 10 amps  
 P251-0031: N.O. 30 amps  
 Case Dimensions: 3.1" x 3.2" x 1.4" h

Part Number	Volts	Control Voltage	Description
P251-0030	190-600	18 - 30 VAC	Low Cost Three Phase
P251-0031	190-600	115 - 230 VAC	Low Cost Three Phase

### Single Phase Monitor

#### Features / Application

- Low cost single phase motor protection.
- Built-in anti-short cycle protection.
- Detects high/low voltage conditions.
- Helps prevent rapid system recycling.
- LED indicator: red for fault, green for normal conditions.
- Heavy duty SPDT, isolated relay output.
- 5-second interrogation delay prevents nuisance trips.

#### Specs

**Input:**  
 Line: 95-270 VAC  
**Output:**  
 Relay, SPDT  
 n.o.: 5 amps  
 n.c.: 5 amps  
**Time delay**  
 Range: adj. 0-600 sec.

#### Replaces

Diversified:  
 CV-100-RS  
 CV-200-RS15  
 CV-200-RS20  
 WATSCO:  
 EAC-401  
 EAC-402  
 EAC-403  
 EAC-404

Part Number	Volts	Description
P251-0092-B	95-270	95-270 VAC Single Phase Monitor

### Defrost Control

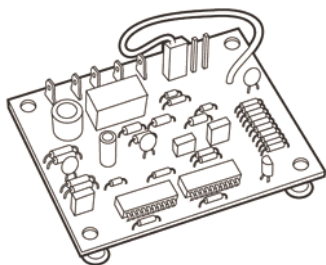

#### Features / Application

- Direct replacement for OEM type 621
- Low cost, time/temperature defrost.
- 24 VAC operation (18-30 VAC).
- 10 min. defrost interval. Pin-selectable interval times (30/60/90).
- Test pins reduce test time by 256x.
- HOLD input accumulates actual compressor run times.
- Sensor input for defrost terminate.
- Conformally coated.

#### Specs

18-30 VAC  
 50/60 Hz  
**Output:**  
 Relay, output  
 Form: SPDT  
 n.o.: 2 amps  
 Defrost: 10min. fixed  
**Time delay**  
 Interval times:  
 Pin selectable  
 30/60/90 min.

#### Replaces

Amana C6431001  
 ARCO 343214  
 Avion DFT100  
 Coleman 30130B3741  
 ICM DFOS  
 Intertherm 6208800  
 Janitrol B12260-06  
 Lennox 66G950  
 Ranco DT2-1000  
 Rheem/Ruud  
 47-21776-02-00  
 Snyder General  
 1052757, 1395-329  
 Weatherking 840-5548

Part Number	Description
P284-2590	18-30 Vac Defrost Control

# TOTALINE® PROTECTION CONTROLS

## Timers And Delays

### Bypass Timer

Electrical

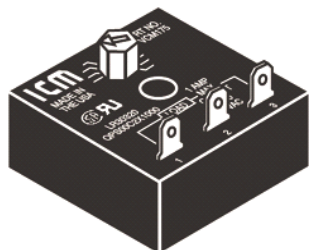

Designed to bypass a control or device during startup. Typically used to bypass a low pressure switch during compressor heat pump startup or to bypass an oil pressure switch upon startup. Helps to eliminate nuisance lockouts.

#### Features / Application

- Designed to bypass a low pressure switch or other device during startup.
- Ideal for low ambient startups. Integral component for “winter start” kits.
- Helps to reduce nuisance lockouts.
- Universal AC voltage operation.
- Knob-adjustable time delays. Epoxy-encapsulated circuitry.

#### Specs

18-240 VAC  
1 Amp  
10 Amp inrush  
Knob-adjustable time  
Delays: 10-1,000 sec.

#### Replaces

Mars: 32395  
Supco: TDP68

Part Number	Description
P284-2397	18-240 VAC, 1 Amp Bypass Timer

### Post Purge Fan Delay Timers

#### Model P284-2395

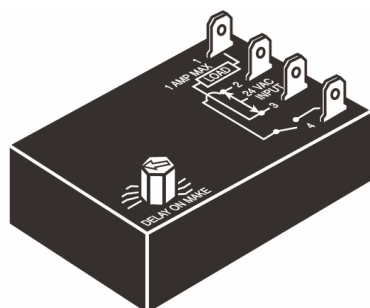

Controls the circulating fan in heat pump, air conditioning and forced air systems. OFF delay timing function continues to run the fan at the end of the heating/cooling cycle, thereby purging ducts of residual air and increasing system efficiency.

#### Features / Application

- Designed to bypass a low pressure switch and other device during startup
- Ideal for low ambient startups. Integral component for “winter start” kits
- Helps to reduce nuisance lockouts
- Universal AC voltage operation
- Knob-adjustable time delays
- Epoxy-encapsulated circuitry

#### Specs

Input: 18-30 VAC  
1 Amp, 10 Amp inrush  
SPST, N.O.  
Time Delays: fixed or adj  
ON: 1-180 sec  
OFF: 12-390 sec

#### Replaces

Mars: 32393  
Gemline: 1C216

Part Number	Description
P284-2395	18-30 VAC, 1 Amp, 10 Amp Inrush

#### Model P284-1216

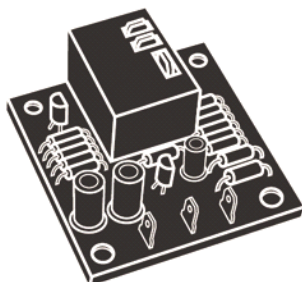

Controls the circulating fan in heat pump, air conditioning and forced air systems. OFF delay timing function continues to run the fan at the end of the heating/cooling cycle, thereby purging ducts of residual air and increasing system efficiency.

#### Features / Application

- Low cost open board design.
- High power, relay output.
- Dual function fan delay timer.
- Controls the circulating fan in heat pump and A/C and forced systems.
- OFF delay purges ducts of residual air.
- ON delay allows air to reach the proper comfort level prior to energizing the fan.

#### Specs

Input: 18-30 VAC  
N.O. -20 amps @240 VAC  
N.C. - 10 amps @240 VAC  
Time delays fixed at:  
ON: 1 sec.  
OFF: 60 sec.

#### Replaces

EMI  
WATSCO: AHBC-060, AHBC-090

Part Number	Description
P284-1216	18-240 VAC, 1 Amp Post Purge Fan Delay Timer



# TOTALINE® PROTECTION CONTROLS

## Timers And Delays

### Delay-On-Break Timer - Not Adjustable

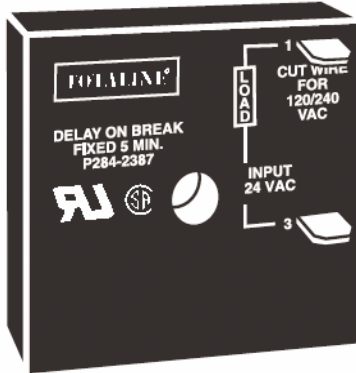

Helps to protect air conditioning, refrigeration and heat pump equipment from damage which may be caused by the rapid short-cycling of compressor.

#### Features / Application

- Higher 1.5 amp power rating.
- Compressor lockout/anti-short cycle timer.
- Helps to protect compressors from damage caused by rapid short cycling
- Simple, 2-wire hookup.
- Compact 2" x 2" package.

#### Specs

Input: 18-30 VAC  
1.5 amps  
15 amp inrush  
Voltage drop  
3.5 V typical  
4.5 V max

#### Replaces

Diversified:  
ASC-500, SC 501,  
SC 505-5  
Gemline: IC321, IC322  
WATSCO: EAC-500,  
EAC501-180-W,  
EAC501-300-W

Part Number	Description
P284-2387	18-30 VAC, 1.5 amps, Delay-On-Break Timers

### Delay-On-Break Timer - Adjustable Delay

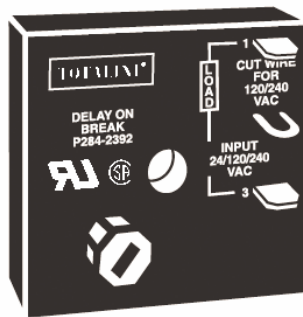

Helps to protect air conditioning, refrigeration and heat pump equipment from damage which may be caused by the rapid short-cycling of compressor.

#### Features / Application

- Universal voltage operation.
- Higher 1.5 amp power rating.
- Compressor lockout/anti-short cycle timer.
- Helps to protect compressors from damage caused by rapid short cycling.
- Simple, 2-wire hookup.
- Compact 2" x 2" package.

#### Specs

Input: 18-240 VAC  
1.5 amps  
15 amp inrush  
Voltage drop  
3.5 V typical  
4.5 V max  
knob adjustable  
delays .03-10 min

#### Replaces

Diversified: ASC-500,  
ASC 501 ASC502,  
ASC 505-5  
Gemline: IC320  
WATSCO: EAC501-ADJ,  
EAC501-ADJ-X  
MARS: 32392  
Robertshaw: 3310-072  
Supco: TD-73

Part Number	Description
P284-2392	18-30 VAC, 1.5 amps, Delay-On-Break Timers

### Delay-On-Break Timer - Fixed and Adjustable Delay

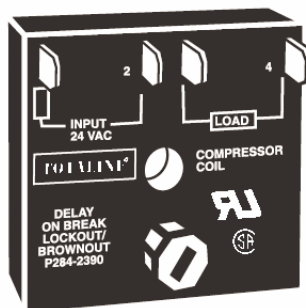

Helps to protect air conditioning, refrigeration and heat pump equipment from damage which may be caused by the rapid short-cycling of compressor.

#### Features / Application

- UL 873 recognition as compressor controller.
- Help to prevent scroll compressors from reversing.
- Fast response time: 16 ms.
- Compressor lockout/anti-short cycle timer.
- Prevents low voltage starts.
- Eliminates relay chatter due to thermostat bounce or tampering.
- Works with anticipator-type thermostats.

#### Specs

Input: 18-30 VAC  
1.5 amps  
15 amp inrush  
3 or 5 min. fixed or 10 min. adjustable time  
delays

#### Replaces

Gemline: IC243  
MARS: 32381 & 32382  
Robertshaw: 3310-183, 3310-305  
WATSCO: EAC-511, EAC-426-180, EAC-426-180, EAC-426-300, EAC-426-ADJ

Part Number	Description
P284-2390	18-30 VAC, 1.5 amps, Delay-On-Break Timers

# TOTALINE® PROTECTION CONTROLS

## Timers And Delays

### Delay-On-Make Timer

Electrical

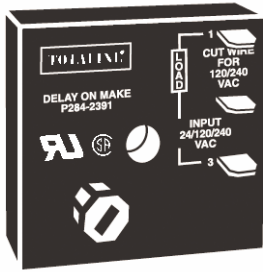

Helps to protect air conditioning, refrigeration and heat pump equipment from damage which may be caused by the rapid short-cycling of compressor.

#### Features / Application

- Universal voltage operation.
- Higher 1.5 amp power rating.
- Knob-adjustable time delays.
- Work with anticipator-type thermostats.
- One model replaces many in field. Ideal for compressor staging.
- Simple 2-wire hookup.
- Compact 2" x 2" package.

#### Specs

Input: 18-240 VAC  
 1.5 amps  
 15 amp inrush  
 SPST, N.O.  
 Adjustable delays  
 .03-10 min.(1.8-600 sec.)  
 Voltage drop:  
 2.5V @ 1.5 amps

#### Replaces

Diversified: AC-800 fixed  
 volt: ASC-00/601  
 Gemline: IC310/ICS213  
 Mars: 32391/32367  
 Robertshaw: 3310-068  
 Supco: TD-68 D-69  
 WATSCO: EAC-701-ADJ.,  
 X, EAC-700-A

Part Number	Description
P284-2391	18-240 VAC, 1.5 amps, Delay-On-Break Timers

## Start Kits

### Smart Start Kits - "Current Sensing"

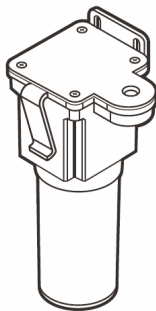

By monitoring the compressor "current" upon start-up, the Smart Start is able to engage the hard start capacitor for precisely the correct amount of time, ensuring maximum starting torque without the risk of supplying too much current into the start winding.

- A timed safety circuit is provided in the event the motor fails to start within 600ms.
- Current sensing Hard Start precisely increases starting torque.
- Operates from 95 - 288 VAC
- Max Input Voltage: 502 VAC
- Patented current sensing circuitry
- Self-Adjusting to voltage fluctuation
- Easy to install, 2 wires, clips or screws
- Bos starting torque
- Disengages upon start

Part Number	HP Rating	Replaces
P290-0803	1/2 - 3 HP	Supco : SPP-8 Kickstart : TO-5 A-1 : WSX-1
P290-0805	3 - 5 HP	Kickstart : KS1
P290-0810	5 - 10 HP	--

### Smart Start Kits - "Voltage Sensing"

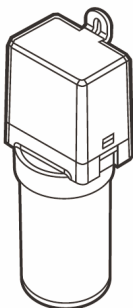

Products employ patented circuitry which monitors differential compressor auxiliary voltage, determines the state of the motor and precisely engages and disengages the start capacitor.

- Not Effected by Ambient temperature
- Recycles instantly (less than 1 second)
- Multi-voltage operation - either 115 or 230 VAC Ideally suited for:
- Water Coolers
- Vending Machines
- Household Refrigerators (115 or 230 VAC)
- Commercial Refrigeration (115 or 230 VAC)
- Air Conditioners and Heat Pumps

Part Number	Voltage	Replaces	Voltagages	MFD	Oper Temp Range	Max Input Voltage	Range	Recommended Range
P290-0850	90-277 VAC	Supco : SPP-5 MARS : 32701 A-1 : WSX-5	330 capacitor	44-52	-40° C to + 65° C	390 VAC	1/12 - 10 HP	1/12 - 1 HP
P290-0860	90-277 VAC	Supco : SPP-6 MARS : 32703 A-1 : WSX-6	330 capacitor	88-106	-40° C to + 65° C	390 VAC	1/12 - 10 HP	1/2 - 1 HP

# FUSES AND ACCESSORIES

## Fuses

### ATO TYPE - 32V AC



Part Number	Min Order	Description
0ATO003.V	100	Auto Blade3 AMP
0ATO004.V	5	Auto Blade4 AMP
0ATO005.V	100	Auto Blade5 AMP
ATO 7-1/2	5	Auto Blade7.5 AMP
0ATO010.V	5	Auto Blade10 AMP
0ATO015.V	5	Auto Blade15 AMP
ATO20	5	Auto Blade20 AMP
ATO25	5	Auto Blade25 AMP
ATO30	5	Auto Blade30 AMP

### FLNR-ID TYPE - 250V



Part Number	Min Order	Description RK5 Dual Elem.
FLNR035.TXID	10	35 AMP
FLNR040.TXID	10	40 AMP
FLNR045.TXID	10	45 AMP
FLNR050.TXID	10	50 AMP
FLNR060.TXID	10	60 AMP
FLNR 70 ID	5	70 AMP
FLNR 80 ID	5	80 AMP
FLNR 90 ID	5	90 AMP
FLNR100.VXID	5	100 AMP
FLNR 200 ID	0	200 AMP

### FLM TYPE - 250V



Part Number	Min Order	Description
FLM 3/10	10	Midget TD 3/10 AMP
0FLM.600T	10	Midget TD 6/10 AMP
FLM 1	10	Midget TD 1 AMP
FLM 2	10	Midget TD 2 AMP
FLM 3	10	Midget TD 3 AMP
FLM 5	10	Midget TD 5 AMP
0FLM008.T	10	Midget TD 8 AMP
0FLM010.T	10	Midget TD 10 AMP
0FLM015.T	10	FUSETRON 15A
0FLM020.T	10	Midget TD 20 AMP
0FLM030.T	10	Midget TD 30 AMP

### FLQ TYPE - 500V



Part Number	Min Order	Description Time Delay Midget
FLQ 1/2	10	1/2 AMP
0FLQ02.5T	10	2 1/2 A
0FLQ003.T	10	3 AMP
FLQ 4	10	4 AMP
0FLQ005.T	10	5 AMP
FLQ 7	10	7 AMP
0FLQ008.T	10	8 AMP
0FLQ010.T	10	10 AMP
0FLQ015.T	10	15 AMP
0FLQ020.T	10	20 AMP
FLQ 25	10	25 AMP
0FLQ030.T	10	30 AMP

### FLNR TYPE - 250V



Part Number	Min Order	Description RK5 Dual Elem.
FLNR3	10	3 AMP
FLNR04.5T	10	4 1/2 AMP
FLNR005.T	10	5 AMP
FLNR010.T	10	10 AMP
FLNR015.T	10	15 AMP
FLNR020.T	10	20 AMP
FLNR025.T	10	25 AMP
FLNR030.T	10	30AMP
FLNR035.T	10	35 AMP
FLNR040.T	10	40AMP
FLNR045.T	10	45 AMP
FLNR050.T	10	50 AMP
FLNR060.T	10	60 AMP
FLNR70	10	70 AMP
FLNR90	10	90 AMP
FLNR100.V	10	100 AMP

### 312 TYPE - 250V



Part Number	Min Order	Description
312.100	5	3AG Glass 1/10 AMP
312.250	5	3AG Glass 1/4 AMP
312.500	5	3AG Glass 1/2 AMP
312.750	5	3AG Glass 3/4 AMP
31201.5	5	3AG Glass 1.5 AMP
0312001.VXP	5	3AG Glass 1 AMP
031202.5VXP	5	3AG Glass 2.5 AMP
0312002.VXP	5	3AG Glass 2 AMP
0312004.VXP	5	3AG Glass 4 AMP
0312005.VXP	5	3AG Glass 5 AMP
0312006.VXP	5	3AG Glass 6 AMP
0312007.VXP	5	3AG Glass 7 AMP
0312008.VXP	5	3AG Glass 8 AMP
0312010.VXP	5	3AG Glass 10 AMP

# FUSES AND ACCESSORIES

## Fuses

Electrical

### 312 TYPE - 32V



P312FUSE

Part Number	Min Order	Description
312012	5	3AG Glass 12 AMP
0312015.VXP	5	3AG Glass 15 AMP
0312020.VXP	5	3AG Glass 20 AMP
031202.5VXP	5	3AG Glass 25 AMP
312030	5	3AG Glass 30 AMP

### 313 TYPE - 250V



P313FUSE

Part Number	Min Order	Description 3AG Glass
313.100	5	3AG Glass 1/10 AMP
0313.125VXP	5	3AG Glass 1/8 AMP
313.200	5	3AG Glass 2/10 AMP
313.250	5	3AG Glass 1/4 AMP
313.400	5	3AG Glass 4/10 AMP
313.600	5	3AG Glass 6/10 AMP
313.700	5	3AG Glass 7/10 AMP
313.750	5	3AG Glass 3/4 AMP
0313001.VXP	5	3AG Glass 1 AMP
031301.5VXP	5	3AG Glass 1.5 AMP
031302.5VXP	5	3AG Glass 2.5 AMP
313002	5	3AG Glass 2 AMP
0313003.VXP	5	3AG Glass 3 AMP
313004	5	3AG Glass 4 AMP
0313005.VXP	5	3AG Glass 5 AMP
313007	5	3AG Glass 7 AMP
313008	5	3AG Glass 8 AMP

### 313 TYPE - 32V



P313FUSE

Part Number	Min Order	Description
0313010.VXIDP	5	3AG Glass 10 AMP
313015	5	3AG Glass 15 AMP

### 314 TYPE - 250V



P314FUSE

Part Number	Min Order	Description
314001	5	3AB Ceramic 1 AMP
314002	5	3AB Ceramic 2 AMP
0314003.VXP	5	3AB Ceramic 3 AMP
0314004.VXP	5	3AB Ceramic 4 AMP
0314005.VXP	5	3AB Ceramic 5 AMP
0314006.VXP	5	3AB Ceramic 6 AMP
0314008.VXP	5	3AB Ceramic 8 AMP
0314010.VXP	5	3AB Ceramic 10 AMP
0314015.VXP	5	3AB Ceramic 15 AMP
0314020.VXP	5	3AB Ceramic 20 AMP

### 362 TYPE - 250V



P362FUSE

Part Number	Min Order	Description
362.250	5	8AG Glass 1/8 AMP
362.400	5	8AG Glass 3/16 AMP
362.500	5	8AG Glass 1/4 AMP
036201.5V	5	8AG Glass 1/2 AMP
MDA2	5	8AG Glass 1 AMP
036202.5V	5	8AG Glass 2.5 AMP
0362005.V	5	8AG Glass 3 AMP

### FLSR-ID TYPE - 600V



PFLSR-ID

Part Number	Min Order	Description RK5 Dual Elem.
FLSR 10 ID	10	10 AMP
FLSR015.TXID	10	15 AMP
FLSR020.TXID	10	20 AMP
FLSR025.TXID	10	25 AMP
FLSR030.TXID	10	30 AMP
FLSR035.TXID	10	35 AMP
FLSR040.TXID	10	40 AMP
FLSR045.TXID	10	45 AMP
FLSR050.TXID	10	50 AMP
FLSR060.TXID	10	60 AMP
FLSR070.VXID	5	70 AMP
FLSR080.VXID	5	80 AMP
FLSR090.VXID	5	90 AMP

# FUSES AND ACCESSORIES

## Fuses

### FLSR TYPE - 600V



PFLSRFUS

Part Number	Min Order	Description RK5 Dual Element
FLSR010.T	10	10 AMP
FLSR015.T	10	15 AMP
FLSR020.T	10	20 AMP
FLSR025.T	10	25 AMP
FLSR030.T	10	30 AMP
FLSR035.T	10	35 AMP
FLSR040.T	10	40 AMP
FLSR 45	10	45 AMP
FLSR050.T	10	50 AMP
FLSR060.T	10	60 AMP
FLSR070.V	5	70 AMP
FLSR 80	5	80 AMP
FLSR 100	5	100 AMP

### KLK TYPE - 600V



PKLKFUSE

Part Number	Min Order	Description
OKLK.300T	10	Midget 3/10 AMP
KLK 1/2	10	Midget 1/2 AMP
KLK 1	10	Midget 1 AM.
OKLK01.5T	10	Midget 1-1/2 AMP
KLK 2	10	Midget 2 AMP
OKLK02.5T	10	Midget 2-1/2 AMP
OKLK003.T	10	Midget 3 AMP
OKLK03.5T	10	Midget 3-1/2 AMP
OKLK004.T	10	Midget 4 AMP
OKLK005.T	10	Midget 5 AMP
OKLK007.T	10	Midget 7 AMP
OKLK008.T	10	Midget 8 AMP
OKLK010.T	10	Midget 10 AMP
OKLK020.T	10	Midget 20 AMP
KLK 25	10	Midget 25 AMP
OKLK030.T	10	Midget 30 AMP

### JLLS TYPE - 600V AC



PJLLSFUS

Part Number	Min Order	Description
JLLS015.T	10	15 AMP
JLLS025.T	10	25 AMP
JLLS030.T	10	30 AMP
JLLS035.T	10	35 AMP
JLLS050.T	10	50 AMP
JLLS060.T	10	60 AMP

### KLKR TYPE - 600 V



PKLKRFS

Part Number	Min Order	Description
KLKR 1-1/2	10	Midget 1-1/2 AMP
KLKR002.T	10	Midget 2 AMP
KLKR 3-1/2	10	Midget 3-1/2 AMP
KLKR 5	10	Midget 2 AMP
KLKR006.T	10	Midget 3-1/2 AMP
KLKR010.T	10	Midget 4 AMP
KLKR015.T	10	Midget 5 AMP
KLKR020.T	10	Midget 6 AMP
KLKR030.T	10	Midget 10 AMP

### KLDR TYPE - 600V



PKLDRFUS

Part Number	Min Order	Descriptionn UL Glass
KLDR.250T	10	1/4A
KLDR.500T	10	1/2A
KLDR 1	10	1A
KLDR 1-1/2	10	1.5A
KLDR002.T	10	2A
KLDR02.5T	10	2.5A
KLDR003.T	10	3A
KLDR03.5T	10	3.5A
KLDR 4	10	4A
KLDR005.T	10	5A
KLDR008.T	10	8A
KLDR010.T	10	10A

### LGR TYPE - 300V



PLGRFUSE

Part Number	Min Order	Description Knob Assm
0LGR003.V	5	3 AMP
0LGR004.V	5	4 AMP
LGR 10	5	10 AMP

### NLN TYPE - 250V



PNLNFUSE

Part Number	Min Order	Description UL Class K5
ONLN010.T	10	10 AMP
NLN 15	10	15 AMP
NLN030	10	30 AMP
NLN 40	10	40 AMP
ONLN060.T	10	60 AMP

# FUSES AND ACCESSORIES

## Fuses

### SLC TYPE - 600V



PSLCFUSE

Part Number	Min Order	Description Class G Medium TD
0SLC002.T	10	2 AMP
0SLC003.T	10	3 AMP
0SLC005.T	10	5 AMP
0SLC006.T	10	6 AMP
SLC 8	10	8 AMP
0SLC010.T	10	10 AMP
0SLC015.T	10	15 AMP
0SLC020.T	10	20 AMP

### SLC TYPE - 480V



PSLCFUSE

Part Number	Min Order	Description Class G Medium TD
0SLC025.T	10	25 AMP
0SLC030.T	10	30 AMP
0SLC035.T	10	35 AMP
0SLC040.T	10	40 AMP

### SLO TYPE

Part Number	Min Order	Description Medium Time Delay
0SLO015.Z	4	15 AMP

### SOO TYPE

Part Number	Min Order	Description Dual Element TD
0SOO010.Z	4	10 AMP
SOO 1-1/4	4	1 1/4 AMP
0SOO012.Z	4	12 AMP
0SOO015.Z	4	15 AMP
0SOO020.Z	4	20 AMP
SOO 30	4	30 AMP
SOO 5	4	5 AMP
0SOO6.25Z	4	6 1/4 A
SOO 8	4	8 AMP

### TLO TYPE

Part Number	Min Order	Description Medium Time Delay
TLO 15	4	20 AMP
TLO 20	4	25 AMP
TLO 30	4	15 AMP

### TOO TYPE

Part Number	Min Order	Description Dual Element TD
TOO 10	4	10 AMP
TOO 12	4	12 AMP
OTOO015.Z	4	15 AMP
OTOO020.Z	4	20 AMP
TOO 25	4	25 AMP
OTOO030.Z	4	30 AMP
TOO 3-1/2	4	3-1/2 AMP
TOO 5	4	5 AMP
TOO 6-1/4	4	6-1/4 AMP

### Littelfuse Fuse Accessories

#### Panel Mounted Fuse Holders

Standard For 1-13/32" - 1-1/2" Diameter Midget And Class CC Fuses

Part Number	Fuse Length Range	For Use With
057100CCL	1-1/2"	Class CC Fuses

Standard For 13/32" Diameter Midget And Class CC Fuses

Part Number	Fuse Length Range	For Use With
571027	1-5/16 - 1-3/8	Midget Fuses
571007	1-13/32 - 1-1/2	Midget Fuses

Standard For 3AG 1-1/4" x 1/4" Fuses With Low Profile Fingertip Knob

Part Number	AMPS	VOLTS
03453LF8X	15	250

#### In-Line Fuse Holders

Model 155 020U

For Type Sfe Fuses

Unassembled: For Assembly to #14 AWG Wire

Part Number	For Fuse Size
155020U	1/4 in. x 1-1/4 in. 20A

\*Comes with GLQ 10A fuse.

\*\*Comes with GMQ 3-1/2A fuse.

Model 01550020ZXA

ASSEMBLED: Includes SFE 20 and 19" LOOP of #14 AWG Red Vinyl Insulated Wire

Part Number	Fuse Installed
01550020ZXA	SFE 20

# FUSES AND ACCESSORIES

## Littelfuse Fuse Accessories

### Midget Fuse Blocks

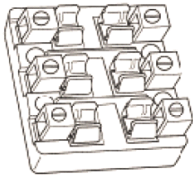

- 3 Poles
- Pressure plate/Q.C. terminals
- Max wire size of #10 CU
- Rated for 30 Amperes, 600 Volts (Amperage Range: 2/10–60)

Part Number	Amperage Range:
L60030M-3PQ	2/10–60

### Box Cover Units For Plug Fuses

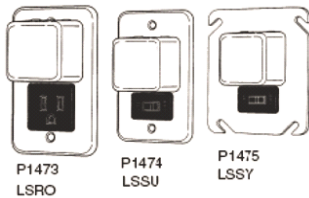

Part Number	Features	To Be Mounted On
LSRU	One Edison-Base Fuse Holder & Grounding Receptacle	2-1/4 in. Handy Box
LSSU	One Edison-Base Fuse Holder & Single Pole Switch	2-1/4 in. Handy Box
LSSY*	One Edison-Base Fuse Holder & Single Pole Switch	4 in. Square Box

\* Do not use on DC.

### Universal In-Line Fuseholder

Supplied with 15" loop of #14 AWG wire and 3 springs to accommodate SFE sized fuses.

Part Number
01500145Z

### Heavy Duty In-line Fuseholder For ATO Fuses

Use with ATO 25 and 30 amp fuses. Supplied with two 4" wire leads of 12 gauge orange wire.

Part Number	Description
FHA 2	Heavy Duty In-line Fuseholder

### Fuse Pullers Midget Fuse Pullers

For use with 3/16" to 1/2" diameter Fuses.

Part Number	Description
MFP	Midget Fuse Puller

### Pocket Fuse Puller

For use with:  
 0 – 200 A 250V  
 0 – 100 A 600V  
 (9/16" – 1-19/32" diameter Fuses)

Part Number	Description
LPFP	Pocket Fuse Puller

### Class T Fuse Blocks

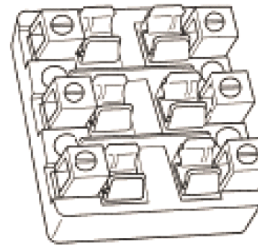

- For use with JLLS (600 V) type fuses
- 3 Poles
- Box lug connector type
- Max wire size of #2 CU-AL

Part Number	Amp rating
LT600303CR	30
LT600603CR	60

### 3 AG Omni Blok

- Molded base type fuse block
- 1 Pole
- NEMA Style 1/4" Q.C. terminal
- Anti-rotation boss
- Rated for 30 A, 300 V

Part Number	Description
354921BL	300V, 3 Ag Omni Blok

### Class H Fuse Blocks

- For use with NLN (600 V) Type uses
- 3 Poles

Part Number	Amp rating	Connecror Type	Max Wire Size
LH25030-3S	30	SCREW	#10 CU
LH25060-3S	60	SCREW	#10 CU
LH60060-3C	30	BOX LUG	#2 CU-AL

# TOTALINE® WIRING ACCESSORIES

## Terminal Kits

### Terminal & Tool Organizer



**A 21 compartment, metal box with a sturdy plastic tray insert and a metal latch.**

This Terminal Kit Box provides organized storage for solder less terminals, connectors and your crimping tool. The lid features a matrix chart for part number identification.

Part Number	Color	Size	Description
P298-TKBOX	Black	13.5" x 9.5" x 2"	Terminal Kit Box

### HVAC Electrical Repair Kit

**TOTALINE HVAC Electrical Repair Kit contains 400 of the most popular terminals & connectors as well as a crimping tool** for the 22-10 AWG wire ranges. The terminals are stored in a metal terminal box with a sturdy plastic 21 compartment insert and a metal latch for securing the lid. TOTALINE graphics appear on the label set, with a matrix chart on the inside lid describing the parts, including illustrations and individual TOTALINE re-order part numbers.

Part Number	Color	Size	Description
P298-HVACKIT	Black	13.75" x 9" x 2.25"	AC Electrical Repair Kit

## Cable Ties - Natural Color

### Standard Ties



- Versatile, multiple purpose
- Extra Strong For Move Demanding Application

Part Number	Minimum Tensile Unlocking Strength	Maximum Bundle Diameter	Width	Length	Qty/Pkg
P298-TF3	18 lbs. (8.2 kg)	7/8" (22.2 mm)	.095" (2.4 mm)	4.1" (10.4 cm)	100
P298-TF3B	18 lbs. (8.2 kg)	7/8" (22.2 mm)	.095" (2.4 mm)	4.1" (10.4 cm)	1000
P298-TF4	40 lbs. (18.1 kg)	1-7/16" (36.5 mm)	.140" (3.5 mm)	5.8" (14.8 cm)	100
P298-TF4B	40 lbs. (18.1 kg)	1-7/16" (36.5 mm)	.140" (3.5 mm)	5.8" (14.8 cm)	1000
P298-TF5	50 lbs. (22.7 kg)	1-7/8" (47.6 mm)	.180" (4.5 mm)	7.5" (19.2 cm)	100
P298-TF5B	50 lbs. (22.7 kg)	1-7/8" (47.6 mm)	.180" (4.5 mm)	7.5" (19.2 cm)	1000
P298-TF6	50 lbs. (22.7 kg)	3-1/16" (77.7 mm)	.180" (4.5 mm)	11.3" (28.5 cm)	50
P298-TF6B	50 lbs. (22.7 kg)	3-1/16" (77.7 mm)	.180" (4.5 mm)	11.3" (28.5 cm)	1000
P298-TF8	50 lbs. (22.7 kg)	4-1/8" (104.7 mm)	.180" (4.5 mm)	14.5" (36.9 cm)	50
P298-TF8B	50 lbs. (22.7 kg)	4-1/8" (104.7 mm)	.180" (4.5 mm)	14.5" (36.9 cm)	1000

### Heavy Duty Ties

Part Number	Minimum Tensile Unlocking Strength	Maximum Bundle Diameter	Width	Length	Qty/Pkg
P298-TF7	120 lbs. (54.4 kg)	4-1/16" (103.1 mm)	.300" (7.6 mm)	15" (38.3 cm)	25
P298-TF7B	120 lbs. (54.4 kg)	4-1/16" (103.1 mm)	.300" (7.6 mm)	15" (38.3 cm)	500



# TOTALINE® WIRING ACCESSORIES

## Cable Ties - Natural Color

### Heavy Duty Duct Straps



- For use with flexible air ducts and air connectors

Part Number	Minimum Tensile Unlocking Strength	Maximum Bundle Diameter	Width	Length	Qty/Pkg
P298-TF12	175 lbs. (79.3 kg)	11" (279.4 mm)	.340" (8.6 mm)	37.3" (94.6 cm)	25
P298-TF48	175 lbs. (79.3 kg)	14.5" (368.3mm)	.340" (8.6 mm)	48.5" (123.1 cm)	25
P298-TF488	175 lbs. (79.3 kg)	14.5" (368.3mm)	.340" (8.6 mm)	48.5" (123.1 cm)	(Gray)25

### Mounting Cable Ties One Piece

Part Number	Minimum Tensile Unlocking Strength	Maximum Bundle Diameter	Width	Length	Qty/Pkg
P298-TF3H	30 lbs. (13.6 kg)	1-1/4" (31.7 mm)	.138" (3.5 mm)	5.8" (14.9 cm)	100
P298-TF3HB	30 lbs. (13.6 kg)	1-1/4" (31.7 mm)	.138" (3.5 mm)	5.8" (14.9 cm)	1000
P298-TF5H	50 lbs. (22.7 kg)	1-3/4" (44.4 mm)	.177" (4.4 mm)	8.0" (20.3 cm)	50
P298-TF5HB	50 lbs. (22.7 kg)	1-3/4" (44.4 mm)	.177" (4.4 mm)	8.0" (20.3 cm)	1000
P298-TF7H	120 lbs. (54.4 kg)	4-1/16" (103.1 mm)	.298" (7.5 mm)	15.7" (39.8 cm)	50
P298-TF7HB	120 lbs. (54.4 kg)	4-1/16" (103.1 mm)	.298" (7.5 mm)	15.7" (39.8 cm)	500

## Cable Ties - Black

### Standard Ties



- Versatile, multiple purpose

Part Number	Minimum Tensile Unlocking Strength	Maximum Bundle Diameter	Width	Length	Qty/Pkg
P298-TF3X	18 lbs. (8.2 kg)	7/8" (22.2 mm)	.095" (2.4 mm)	4.1" (10.4 cm)	100
P298-TF3XB	18 lbs. (8.2 kg)	7/8" (22.2 mm)	.095" (2.4 mm)	4.1" (10.4 cm)	1000
P298-TF4X	40 lbs. (18.1 kg)	1-7/16" (36.5 mm)	.140" (3.5 mm)	5.8" (14.8 cm)	100
P298-TF4XB	40 lbs. (18.1 kg)	1-7/16" (36.5 mm)	.140" (3.5 mm)	5.8" (14.8 cm)	1000
P298-TF5X	50 lbs. (22.7 kg)	1-7/8" (47.6 mm)	.180" (4.5 mm)	7.5" (19.2 cm)	100
P298-TF5XB	50 lbs. (22.7 kg)	1-7/8" (47.6 mm)	.180" (4.5 mm)	7.5" (19.2 cm)	1000
P298-TF6X	50 lbs. (22.7 kg)	3-1/16" (77.7 mm)	.180" (4.5 mm)	11.3" (28.5 cm)	50
P298-TF6XB	50 lbs. (22.7 kg)	3-1/16" (77.7 mm)	.180" (4.5 mm)	11.3" (28.5 cm)	1000
P298-TF8X	50 lbs. (22.7 kg)	4-1/8" (104.7 mm)	.180" (4.5 mm)	14.5" (36.9 cm)	50
P298-TF8XB	50 lbs. (22.7 kg)	4-1/8" (104.7 mm)	.180" (4.5 mm)	14.5" (36.9 cm)	1000

### Heavy Duty Ties



- For use with flexible air ducts and air connectors

Part Number	Minimum Tensile Unlocking Strength	Maximum Bundle Diameter	Width	Length	Qty/Pkg
P298-TF7X	120 lbs. (54.4 kg)	4-1/16" (103.1 mm)	.300" (7.6 mm)	15" (38.3 cm)	25
P298-TF7XB	120 lbs. (54.4 kg)	4-1/16" (103.1 mm)	.300" (7.6 mm)	15" (38.3 cm)	500

# 2015 TOTALINE<sup>®</sup> HVAC/R PARTS CATALOG

# COMPRESSORS



**Universal HVAC/R  
Parts and Supplies**

# TOTALINE® WIRING ACCESSORIES

## Terminals And Connectors

### Compressor Terminal

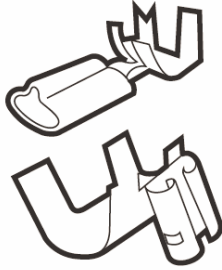

Part Number	Tab Width In (mm)	Wire Range AWG (mm2)	Qty/Pkg
P298-COM1208	.250 (6.35)	12-8 (4.0-6.75)	20

### Self-Stripping Tap Connectors

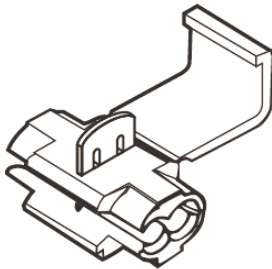

Part Number	Wire Range AWG (mm2)	Qty/Pkg
P298-SSTCR	22-16 (0.5-1.0) Red	25
P298-SSTCB	18-14 (.75-2.5) Blue	25
P298-SSTCY	12-10 (4.0-6.0) Yellow	20

### Compressor Hook-up Lead Kit

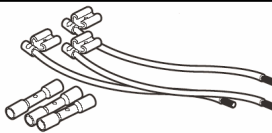

Part Number	Tab Width In (mm)	Wire Range AWG (mm2)	Qty/Pkg
P298-LEADS-10	.250 (6.35)	10 (6.0)	3-8" Leads With Flags 3-Heat Shrinkable Butt Connectors

### Closed End Connectors - Nylon Insulated

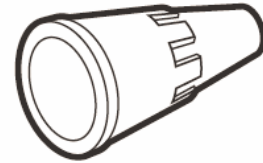

Part Number	Wire Range-AWG	Qty/Pkg
P298-CES2214	22-14 (0.5-2.5)	50
P298-CES1810	18-10 (1.0-6.0)	40

### Twist-On Wire Connectors

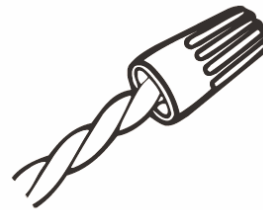

UL Listed/CSA Approved 221°F/105°C (Available in Blister Boxes, TOTALINE Boxes or Bulk Packs)

Part Number	AWG	(mm2)	Color/Voltage	Qty/Pkg
P298-WC/GREY	22-14 (0.5-2.5)	Min. 2 #22	Grey	100 (Blister Box)
P298-WC/GREY/M	22-14 (0.5-2.5)	Max. 2 #16	300 Volt	1,000 (Bulk Pack)
P298-29	22-14 (0.5-2.5)	Min. 2 #18	Blue	100 (Blister Box)
P298-29B	22-14 (0.5-2.5)	Max. 3 #16	300 Volt	100 (Totaline Box)
P298-WC/BLUE/M	22-14 (0.5-2.5)	--	--	1,000 (Bulk Pack)
P298-31	22-14 (0.5-2.5)	Min. 2 #18	Orange	75 (Blister Box)
P298-31B	22-14 (0.5-2.5)	Max. 2 #14	600 Volt	100 (Totaline Box)
P298-WC/ORANGE/D	22-14 (0.5-2.5)	--	--	500 (Bulk Pack)
P298-33	18-10 (1.0-6.0)	Min. 3 #18	Yellow	
P298-33B	18-10 (1.0-6.0)	Max. 4 #14 and 1 #18	600 Volt	100 (Totaline Box)
P298-WC/YELLOW/D	18-10 (1.0-6.0)	--	--	500 (Bulk Pack)
P298-35	18-8 (1.0-8.0)	Min. 2 #14	Red	35 (Blister Box)
P298-35B	18-8 (1.0-8.0)	Max. 4 #12	600 VOLT	100 (Totaline Box)
P298-WC/RED/D	18-8 (1.0-8.0)	--	--	500 (Bulk Pack)

# TOTALINE® WIRING ACCESSORIES

## Terminals And Connectors

P298-YS6	12-10 (4.0-6.0) Yellow	#6	-3.5	75
P298-YS8	12-10 (4.0-6.0) Yellow	#8	-4.16	75
P298-YS10	12-10 (4.0-6.0) Yellow	#10	-4.82	75

### Ring Terminals



- Vinyl Insulated

Part Number	Wire Range AWG (mm2)	In / Ga	(mm)	Qty/Pkg
P298-RR6	22-18 (0.5-1.0) Red	#6	-3.5	100
P298-RR8	22-18 (0.5-1.0) Red	#8	-4.16	100
P298-RR10	22-18 (0.5-1.0) Red	#10	-4.82	100
P298-RR0250	22-18 (0.5-1.0) Red	1/4"	-6.35	75
P298-RR0375	22-18 (0.5-1.0) Red	3/8"	-9.53	65
P298-BR6	16-14 (1.5-2.5) Blue	#6	-3.5	100
P298-BR8	16-14 (1.5-2.5) Blue	#8	-4.16	100
P298-BR10	16-14 (1.5-2.5) Blue	#10	-4.82	100
P298-BR0250	16-14 (1.5-2.5) Blue	1/4"	-6.35	75
P298-BR0315	16-14 (1.5-2.5) Blue	5/16"	-7.94	65
P298-BR0375	16-14 (1.5-2.5) Blue	3/8"	-9.53	65
P298-YR6	12-10 (4.0-6.0) Yellow	#6	-3.5	75
P298-YR8	12-10 (4.0-6.0) Yellow	#8	-4.16	75
P298-YR10	12-10 (4.0-6.0) Yellow	#10	-4.82	75
P298-YR0250	12-10 (4.0-6.0) Yellow	1/4"	-6.35	60
P298-YR0315	12-10 (4.0-6.0) Yellow	5/16"	-7.94	60
P298-YR0375	12-10 (4.0-6.0) Yellow	3/8"	-9.53	60
P298-YR0500	12-10 (4.0-6.0) Yellow	1/2"	-12.7	40

### Heavy Duty Ring Terminals

- Vinyl Insulated

Part Number	Wire Range Awg (mm2)	In / Ga	(mm)	Qty/Pkg
P298-8R0250	8 (8.0) Red	1/4"	-6.35	20
P298-8R0315	8 (8.0) Red	5/16"	-7.94	20
P298-8R0375	8 (8.0) Red	3/8"	-9.53	20
P298-8R0500	8 (8.0) Red	1/2"	-12.7	15
P298-6R0250	6 (14.0) Blue	1/4"	-6.35	15
P298-6R0315	6 (14.0) Blue	5/16"	-7.94	15
P298-6R0375	6 (14.0) Blue	3/8"	-9.53	15
P298-6R0500	6 (14.0) Blue	1/2"	-12.7	10

### Block Spade Terminals

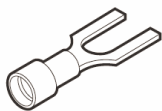

- Vinyl Insulated

Part Number	Wire Range Awg (mm2)	In / Ga	(mm)	Qty/Pkg
P298-RS6	22-18 (0.5-1.0) Red	#6	-3.5	100
P298-RS8	22-18 (0.5-1.0) Red	#8	-4.16	100
P298-RS10	22-18 (0.5-1.0) Red	#10	-4.82	100
P298-BS6	16-14 (1.5-2.5) Blue	#6	-3.5	100
P298-BS8	16-14 (1.5-2.5) Blue	#8	-4.16	100
P298-BS10	16-14 (1.5-2.5) Blue	#10	-4.82	100

### Butt Connectors

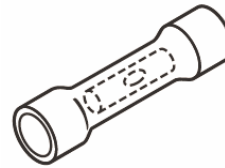

- Vinyl Insulated

Part Number	Wire Range Awg (mm2)	Qty/Pkg
P298-RBS	22-18 (0.5-1.0) Red	100
P298-BBS	16-14 (1.5-2.5) Blue	100
P298-YBS	12-10 (4.0-6.0) Yellow	75

### Heat Shrinkable Butt Connectors



- Environmentally Sealed

Part Number	Wire Range Awg (mm2)	Qty/Pkg
P298-HSRBS	22-18 (0.5-1.0) Red	10
P298-HSBBS	16-14 (1.5-2.5) Blue	10
P298-HSYBS	12-10 (4.0-6.0) Yellow	8

### Double Male-Female Adapters

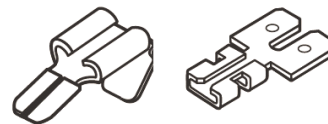

Part Number	Tab Width In (mm)	Qty/Pkg
P298-77250	.250 (6.35) (Piggyback)	30
P298-7MMF187	.187 (4.75) (Flat)	40
P298-7MMF250	.250 (6.35) (Flat)	40

### Multi-Stack Disconnects

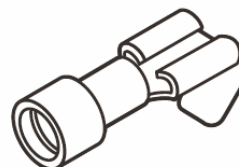

- Vinyl Insulated

Part Number	Tab Width In (mm)	Wire Range Awg (mm2)	Qty/Pkg
P298-RQDFM	.250 (6.35)	22-18 (0.5-1.0) Red	30
P298-BQDFM	.250 (6.35)	16-14 (1.5-2.5) Blue	30

# TOTALINE® WIRING ACCESSORIES

## Terminals And Connectors

P298-HTYR6	12-10 (4.0-6.0)	#6	-3.5	75
P298-HTYR10	12-10 (4.0-6.0)	#10	-4.82	75
P298-HTYR0250	12-10 (4.0-6.0)	1/4"	-6.35	60

### Double Male Quick Disconnects

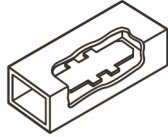

- Vinyl Insulated

Part Number	Tab Width In (mm)	Qty/Pkg
P298-DMD250	.250 (6.35)	10

### Female Flag Quick Disconnects

*Uninsulated*

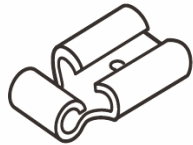

Part Number	Tab Width In (mm)	Wire Range AWG (mm2)	Qty/Pkg
P298-RF187	.187 (4.75)	22-18 (0.5-1.0)	50
P298-RF250	.250 (6.35)	22-18 (0.5-1.0)	50
P298-BF187	.187 (4.75)	16-14 (1.5-2.5)	50
P298-BF250	.250 (6.35)	16-14 (1.5-2.5)	50
P298-YF250	.250 (6.35)	12-10 (4.0-6.0)	40

*Fully Insulated Nylon*



Part Number	Tab Width In (mm)	Wire Range AWG (mm2)	Qty/Pkg
P298-RFFI187	.187 (4.75)	22-18 (0.5-1.0)	30
P298-RFFI250	.250 (6.35)	Red	30
P298-BFFI187	.187 (4.75)	16-14 (1.5-2.5)	30
P298-BFFI250	.250 (6.35)	Blue	30

### High Temperature Ring Terminals

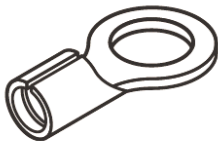

900°F / 482°C Continuous Temperature Rating. Steel Construction. Nickel Plating

Part Number	Wire Range AWG (mm2)	In / Ga	(mm)	Qty/Pkg
P298-HTRR6	22-18 (0.5-1.0)	#6	-3.5	100
P298-HTRR10	22-18 (0.5-1.0)	#10	-4.82	100
P298-HTBR6	16-14 (1.5-2.5)	#6	-3.5	100
P298-HTBR10	16-14 (1.5-2.5)	#10	-4.82	100
P298-HTBR0250	16-14 (1.5-2.5)	1/4"	-6.35	75

### High Temperature Butt Connectors

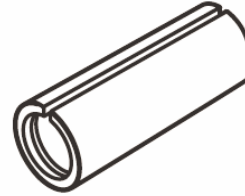

Part Number	Wire Range AWG (mm2)	Qty/Pkg
P298-HTRBS	22-18 (0.5-1.0)	100
P298-HTBBS	16-14 (1.5-2.5)	100
P298-HTYBS	12-10 (4.0-6.0)	75

### High Temperature Female Quick Disconnect

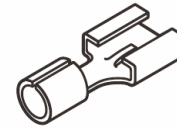

- Vinyl Insulated

Part Number	Wire Range AWG (mm2)	In / Ga	(mm)	Qty/Pkg
P298-HTBQDF250	16-14 (1.5-2.5)	0.25	-6.35	100

### Quick Disconnect Terminals

*Female*

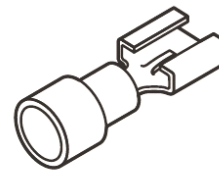

- Vinyl Insulated
- Female

Part Number	Tab Width In (mm)	Wire Range AWG (mm2)	Qty/Pkg
P298-RQDF110	.110 (2.79)	22-18 (0.5-1.0) Red	100
P298-RQDF187	.187 (4.75)	22-18 (0.5-1.0) Red	100
P298-RQDF250	.250 (6.35)	22-18 (0.5-1.0) Red	100
P298-BQDF110	.110 (2.79)	16-14 (1.5-2.5) Blue	100
P298-BQDF187	.187 (4.75)	16-14 (1.5-2.5) Blue	100
P298-BQDF250	.250 (6.35)	16-14 (1.5-2.5) Blue	100
P298-YQDF250	.250 (6.35)	12-10 (4.0-6.0) Yellow	75

# TOTALINE® WIRING ACCESSORIES

## Terminals And Connectors

### Quick Disconnect Terminals

Male

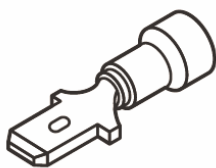

- Vinyl Insulated
- Male

Part Number	Tab Width In (mm)	Wire Range AWG (mm2)	Qty/Pkg
P298-RQDM187	.187 (4.75)	22-18 (0.5-1.0) Red	100
P298-RQDM250	.250 (6.35)	22-18 (0.5-1.0) Red	100
P298-BQDM187	.187 (4.75)	16-14 (1.5-2.5) Blue	100
P298-BQDM250	.250 (6.35)	16-14 (1.5-2.5) Blue	100
P298-YQDM250	.250 (6.35)	12-10 (4.0-6.0) Yellow	75

### Mating Fully Insulated Quick Disconnects

Female



- Nylon Insulated
- Female

Part Number	Tab Width In (mm)	Wire Range AWG (mm2)	Qty/Pkg
P298-RQDFI187	.187 (4.75)	22-18 (0.5-1.0) Red	40
P298-RQDFI250	.250 (6.35)	22-18 (0.5-1.0) Red	40
P298-BQDFI187	.187 (4.75)	16-14 (1.5-2.5) Blue	40
P298-BQDFI250	.250 (6.35)	16-14 (1.5-2.5) Blue	40
P298-YQDFI250	.250 (6.35)	12-10 (4.0-6.0) Yellow	30

### High Temperature Spade Terminals

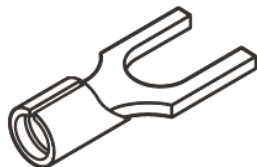

Part Number	Wire Range AWG (mm2)	In / Ga	(mm)	Qty/Pkg
P298-HTRS10	22-18 (0.5-1.0)	#10	-4.82	100
P298-HTBS10	16-14 (1.5-2.5)	#10	-4.82	100
P298-HTYS10	12-10 (4.0-6.0)	#10	-4.82	75

### High Temperature Female Flag Disconnect



Part Number	Wire Range AWG (mm2)	In / Ga	(mm)	Qty/Pkg
P298-HTBFF250	16-14 (1.5-2.5)	0.25	-6.35	75

### High Temperature Male Quick Disconnect

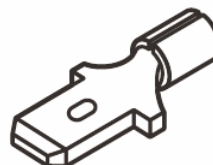

Part Number	Wire Range AWG (mm2)	In / Ga	(mm)	Qty/Pkg
P298-HTBQDM250	16-14 (1.5-2.5)	0.25	-6.35	100

### Mating Fully Insulated Quick Disconnects



- Nylon Insulated
- Male

Part Number	Tab Width In (mm)	Wire Range AWG (mm2)	Qty/Pkg
P298-RQDMFI187	.187 (4.75)	22-18 (0.5-1.0) Red	40
P298-RQDMFI250	.250 (6.35)	22-18 (0.5-1.0) Red	40
P298-BQDMFI187	.187 (4.75)	16-14 (1.5-2.5) Blue	40
P298-BQDMFI250	.250 (6.35)	16-14 (1.5-2.5) Blue	40
P298-YQDMFI250	.250 (6.35)	12-10 (4.0-6.0) Yellow	30

### Snap Plugs



- Vinyl Insulated

Part Number	Wire Range AWG (mm2)	in	(mm)	Qty/Pkg
P298-RBM157	22-18 (0.5-1.0) Red	0.157	3.99	80
P298-RBM176	22-18 (0.5-1.0) Red	0.176	4.47	80
P298-BBM157	16-14 (1.5-2.5) Blue	0.157	3.99	80
P298-BBM176	16-14 (1.5-2.5) Blue	0.176	4.47	80
P298-YBM157	12-10 (4.0-6.0) Yellow	0.157	3.99	60
P298-YBM176	12-10 (4.0-6.0) Yellow	0.176	4.47	60

# TOTALINE® WIRING ACCESSORIES

## Terminals And Connectors

### Snap Plug Receptacles

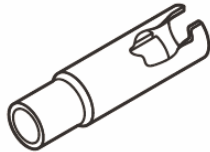

Part Number	Wire Range AWG (mm2)	in	(mm)	Qty/Pkg
P298-RBFFI157	22-18 (0.5-1.0) Red	0.157	3.99	40
P298-RBFFI176	22-18 (0.5-1.0) Red	0.176	4.47	40
P298-BBFFI157	16-14 (1.5-2.5) Blue	0.157	3.99	40
P298-BBFFI176	16-14 (1.5-2.5) Blue	0.176	4.47	40
P298-YBFFI157	12-10 (4.0-6.0) Yellow	0.157	3.99	30
P298-YBFFI176	12-10 (4.0-6.0) Yellow	0.176	4.47	30

### Double Female Snap Plug Receptacles

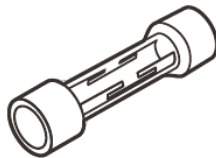

Part Number	Dia.in	(mm)	Qty/Pkg
P298-DBR157	0.157	3.99	40
P298-DBR176	0.176	4.47	40

## Kits And Application Tools

### Twist on Wire Connector Kit - 22-8 AWG



This six section kit is a convenient way to store the complete assortment of color coded twist on connectors and cable ties used daily by HVC/R technicians. Fixed square spring in the connector provides a more secure grip on conductors. CSA and UL approved.

Part Number	Description
P298-TWISTONKIT	22-8 AWG (.33 mm2 to 8.36 mm2) 375 pieces

### Solderless Terminal Kit - 22-10 AWG



An economical 18 compartment, plastic kit box contains 450 of the most popular TOTALINE solderless terminals and connectors.

TOTALINE graphics appear on the label set, with a matrix chart on the inside lid describing the parts, illustrations & individual TOTALINE re-order part numbers.

Part Number	Description
P298-TERMKIT450	22-10 AWG (.33 mm2 to 5.26 mm2) 450 pieces

### Ratchet Action Crimp Tool Kit With 4 Interchangeable Dies



This kit was designed for the professional that insists a high quality commercial grade full cycle crimp tool. System integrity is maintained when components are terminated with this tool. An ergonomic progressive pivoting design provides maximum crimping force with reasonable hand pressure. The ratcheted design eliminates variability from crimp to crimp. This kit includes four interchangeable dies to crimp a variety of solderless terminals.

- Crimp Die "A" for 22-16 AWG (.33 mm2 to 5.26 mm2) insulated Terminals
- Crimp Die "C" for 22-10 AWG (.33 mm2 to 5.26 mm2) insulated Quick Disconnected Terminals
- Crimp Die "22-18/8" for 22-8 AWG (.33 mm2 to 8.36 mm2) uninsulated and high temperature Terminals
- Crimp Die "F" for 22-14 AWG (.33 mm2 to 2.08 mm2) fully insulated flag Terminals

Part Number	Description
P298-25000	Ratchet Action Crimp Tool Kit With 4 Interchangeable Dies

### Repair and Maintenance of HVAC/R Electronic Wiring



This kit was designed as a sales tool for branch sales counters. The kit comes with three totaline application tool as well as solderless Terminals and 5" lengths of wire. Contractors at the sales counters can physically crimp a terminal on a wire or strip a wire to witness firsthand the quality of these tools. The kit includes:

- P298-WS Heavy Duty wire Stripper & Cutter
- P298-RACT Ratchet Action Crimp Tool for 22-10 AWG insulated Terminals
- P298-RACTF Ratchet Action Crimp Tool for 22-14 AWG insulated Flag Terminals

Part Number	Description
P298-DEMOKIT	Application Tool Kit for the Repair and Maintenance of HVAC/R Electronic Wiring

# TOTALINE® WIRING ACCESSORIES

## Kits And Application Tools

### Heavy Duty Tension Tool for installing Duct Straps

**Features:**

- 120 lb to 175 lb duct straps
- Manual tension control
- Neatly cuts off straps
- Metal construction
- Packaged individual box

Part Number	Description
P298-CT300	Manual Cut Off Heavy Duty Tension Tool For 120-175 lb Ties

### Crimping & Stripping Tool 22-12 AWG (.33 mm<sup>2</sup> to 3.308 mm<sup>2</sup>)

This economical crimp tool crimps 22-12 AWG (.33 mm<sup>2</sup> to 3.08 mm<sup>2</sup>) insulated and uninsulated terminals. It strips 22-8 AWG (.33 mm<sup>2</sup> to 8.36 mm<sup>2</sup>) solid or stranded wire; cuts and rethreads five common sizes of bolts. Adjustable machined nut and bolt for precise pivoting. Made from heat treated tool steel with cushioned grip handles.

Part Number
P298-CT

### Heavy Duty Wire Stripper Cutter & Crimping Tool

24-10 AWG (.204 mm<sup>2</sup> to 5.26 mm<sup>2</sup>)



Crimps insulated and uninsulated 22-10 AWG(.33 mm<sup>2</sup> to 5.26 mm<sup>2</sup>) terminals strips 24-10 AWG (.204mm<sup>2</sup> to 5.26 mm<sup>2</sup>) wire includes built in cutter adjustable stopper enables user to pre to pre-determine the required strip length and can be swiveled if user does not require this function.

Part Number	Description
P298-WS	24-10 AWG (.204 mm <sup>2</sup> to 5.26 mm <sup>2</sup> )

### Ratchet Action Crimp Tool for Insulated and Insulated Flag Terminals

Ratcheted design eliminates variability from crimp to crimp. System integrity is maintained when components are terminated with this tool.

Part Number	Description
P298-RACT	22-10 AWG (.32 mm <sup>2</sup> to 5.26 mm <sup>2</sup> )
P298-RACTF	22-14 AWG (.32 mm <sup>2</sup> to 2.08 mm <sup>2</sup> )



# 2015 TOTALINE<sup>®</sup> HVAC/R PARTS CATALOG

---

## MOTORS & ACCESSORIES



**Universal HVAC/R  
Parts and Supplies**

# Table of Contents

## Categorized Listing

<b>Oils &amp; Chemicals</b>	<b>1</b>
TOTALINE® OILS	1
Copeland Scroll Oil	1
Bristol R-410A Compressor oil	1
Solest 170 Polyol Ester Oil	1
Mineral Refrigeration Oils	1
Vacuum Pump Oil	1
Polyol-Ester Oils	1
Alkylbenzene Refrigeration Oils	1
Totaline® Oils Reference for Carlyle and Totaline® Compressors	2
TOTALINE® CHEMICALS	3
Chemicals - Coil Cleaners	3
Chemicals - Other Cleaners	4
Chemicals - Protectors, Inhibitors and Sanitizers	5
Other Chemicals	6
Totaline® Chemical Accessories	6
Touch-Up Paint	9

---

# TOTALINE® OILS

## Copeland Scroll Oil



These oils were specified by Copeland for the first generation scrolls in late 1990s.

Part Number	Size	Type	Duty
P903-1425	1 QT	EAL 22 CC	Refrigeration
P903-1601	1 GAL	3 MA POE	A/C
P903-1625	1 QT	3 MA POE	A/C

## Bristol R-410A Compressor oil

Part Number	Size	Type	Duty
P903-1812	12 OZ CAN	32 BC	A/C

## Solest 170 Polyol Ester Oil

Part Number	Size	Type	Description
SOLEST170-1G	1 GAL	POE	Solest 170 Polyol Ester Oil
SOLEST170-5G	5 GAL	POE	Solest 170 Polyol Ester Oil

## Mineral Refrigeration Oils



This is a refined oil used specifically for air conditioning and refrigeration. The low moisture content means less failure. A non-foaming, waxfree oil to prevent plugged capillaries and sticking expansion valves. OEM approved by most manufacturers.

Part Number	Size	Viscosity
P903-0101	1 GAL (3.8 liters)	150
P903-0105	5 GAL (18.9 liters)	150
P903-0125	1 QT (.95 liters)	150
P903-0155	55 GAL (208.2 liters)	150
P903-0201	1 GAL (3.8 liters)	300
P903-0205	5 GAL (18.9 liters)	300
P903-0255	55 GAL (208.2 liters)	300
P903-0301	1 GAL (3.8 liters)	500
P903-0305	5 GAL (18.9 liters)	500
P903-0355	55 GAL (208.2 liters)	500

## Vacuum Pump Oil

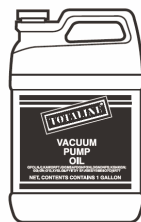

A highly purified purpose vacuum pump oil that cleans and lubricates. The quart bottle (9.5 liters) has a convenient flip-top-cap.

Part Number	Size
P903-0632	1 QT (.95 liters)
P903-0601	1 GAL (3.8 liters)
P903-0605	5 GAL (18.9 liters)
P903-0655	55 GAL (208.2 liters)

## Polyol-Ester Oils



These environmentally friendly products are specifically formulated to use with the non-CFC refrigerant R-134a. The base fluids have been engineered to be totally miscible with R134a over a very wide temperature range while maintaining excellent lubricating properties.

Part Number	Size
P903-1001	1 GAL (3.8 liters)
P903-1005	5 GAL (18.9 liters)
P903-1025	1 QT (.95 liters)
P903-1101	1 GAL (3.8 liters)
P903-1125	1 QT (.95 liters)
P903-1201	1 GAL (3.8 liters)
P903-1205	5 GAL (18.9 liters)
P903-1225	1 QT (.95 liters)
P903-1501	1 GAL (3.8 liters)
P903-1505	5 GAL (18.9 liters)
P903-1525	1 QT (.95 liters)
P903-1701	1 GAL (3.8 liters)
P903-1705	5 GAL (18.9 liters)
P903-1725	32 OZ

## Alkylbenzene Refrigeration Oils



The Z-Series are high quality synthetic Alkylbenzene Refrigeration fluids for use with HCFC, CFC and ammonia refrigerants in refrigeration and air conditioning applications. Due to superior miscibility, Totaline Z-Series lubricants are excellent for systems utilizing environmentally sound refrigerants MP39, MP60, HP80 or HP81. Totaline Z-Series are superior products for all R-22, R-123 and R-502 Systems, particularly at low temperatures. Z-200CX is formulated with a unique additive package providing extreme pressure (EP) lubricity and foam control at operating conditions.

Part Number	Size
P903-2025	1 QT (.95 liters)
P903-2001	1 GAL (3.8 liters)
P903-2005	5 GAL (18.9 liters)
P903-2125	1 QT (.95 liters)
P903-2101	1 GAL (3.8 liters)
P903-2105	5 GAL (18.9 liters)
P903-2225	1 QT (.95 liters)
P903-2201	1 GAL (3.8 liters)
P903-2205	5 GAL (18.9 liters)

# TOTALINE® OILS

## Totaline® Oils Reference for Carlyle and Totaline® Compressors

COMPRESSOR MODEL	REFRIGERANT R-12, R-22 (L & H TEMP.)		REFRIGERANT R-507, R-404A (MED. TEMP)		REFRIGERANT R-507, R-404A (LOW. TEMP)		REFRIGERANT R-134AH (M & H TEMP)	
	OIL MODEL	TOTALINE PART NO.	OIL MODEL	TOTALINE PART NO.	OIL MODEL	TOTALINE PART NO.	OIL MODEL	TOTALINE PART NO.
Carlyle 06D, E semi-hermetic	Z-150	P903-2001	SW68	P903-1001	E68 (Do not use	P903-1725	SW68	P903-1001
		P903-2005		P903-1025	SW-68 for	P903-1701		P903-1025
		P903-2025		P903-1005	Low	P903-1705		P903-1005
					Temp)			
	RO 15	P903-0101						
		P903-0105						
Carlyle 5F/H open	Z-150	P903-2001	SW68	P903-1001	E68 (Do not use	P903-1725	SW 68	P903-1001
		P903-2005		P903-1025	SW-68 for	P903-1701		P903-1025
		P903-2025		P903-1005	Low	P903-1705		P903-1005
					Temp)			
	RO 15	P903-0101						
		P903-0105						
	P903-0155							
		P903-1501		P903-1501		P903-1501		P903-1501
Carlyle 05T/06T Screw (74)	E-100 Solest 170	P903-1505 P903-1525	E-100 Solest 170	P903-1505 P903-1525	E-100 Solest 170	P903-1505 P903-1525	E-100 Solest 170	P903-1505 P903-1525
Carlyle 06N Screw (104 mm Global Chiller)	N/A	N/A	N/A	N/A	N/A	N/A	SW-220 (R-134a Only)	P903-1201 P903-1225 P903-1205
		P903-2001					Mobil Arctic	
Millennium Scroll Technologies		P903-2005					68 Model now	
	Z-150	P903-2025	N/A	N/A	N/A	N/A	obsolete	

### FLUID ANALYSIS

Totaline's Fluid Analysis Service is a cost-effective method of assessing the condition of internal fluids used in all types of HVAC & R equipment and system applications. Sample Kits include the supplies needed to sample, store and ship the fluids to the lab for analysis.

	Description	Available Options
<b>P915-0001</b>	Lithium Bromide Analysis Kit: Uninhibited Nitrate inhibited Chromate inhibited molybdate Aresenite Inhibited Refrigerant Water	Octyl Alcohol Ammonia Arsenite Molybdate & Nitrate Purge Gas
<b>P915-0002</b>	Lithium Chloride Analysis kit: Chromate Inhibited Molybdate Inhibited	GCMS test for volatile arganic Contaminants Molybdate only Chromate Only Dissolved Fe Dissolved Cu"
<b>P915-0003</b>	Brine Analysis Kit (Glycol) – Freeze Pt & Concentration Only	Total Condition Analysis BrineServe™ Energy Analysis"
<b>P915-0004</b>	Fluid Loop Inventory Kit	Glycol Fluid Analysis Glycol Fluid & Energy Analysis
<b>P915-0005</b>	Inorganic Brine Analysis	
<b>P915-0006</b>	Cooling Tower Water Analysis	Ammonia Other Element "
<b>P915-0007</b>	Standard Oil Analysis Kit	Chlorides/Fluorides Ion Activity Viscosity Mixed Oil Percentage
<b>P915-0009</b>	Refrigerant Analysis Kit – Includes DOT – Approved Sample Cylinder, Shipping And Labeling Instruction.	Other refrigerant contamination Non-Condensables
<b>Standard Service</b>	5-7 days turnaround	Oil lib r, refrigerant water & glycol samples
<b>RUSH Service</b>	24-48 hours turnaround	Oil lib r, refrigerant water & glycol samples

# TOTALINE® CHEMICALS

## Chemicals - Coil Cleaners

### Condenser Cleaner Non-Acid Concentrate



**Features:**

- Foams out stubborn deposits from coils.
- Very effective on heavy grease accumulations.
- Ideal for cleaning grease contaminated refrigeration coils and condensers.
- USDA accepted

Part Number	Size
P902-0118	18 OZ AEROSOL
P902-0101	1 GAL (3.8 liters)
P902-0105	6 GAL (22.7 liters)
P902-0135	35 GAL (133 liters)
P902-0155	55 GAL (208.2 liters)

### Indoor Coil Cleaner Concentrate



**Features:**

- Cleans and treats air-conditioning systems for maximum efficiency
- Retards future dirt accumulation
- Eliminates slime in condensate areas
- Easy to use, non-toxic and deodorizes
- Only equipment required is hand-type sprayer.
- USDA accepted.

Part Number	Size
P902-1001	1 GAL (3.8 liters)
P902-1005	6 GAL (22.7 liters)
P902-1055	55 GAL (208.2 liters)
P902-1018	18 oz. Aerosol

### Indoor Coil Cleaner Self-Rinsing Super Concentrate



**Features:**

- No foaming action - only attacks dirt buildup, not metal.
- Dilutes with 24 parts water - 1 quart makes over 6 gallons evaporator cleaner.
- Rinsing not required - normal condensation will carry away dirt and contamination.
- Contains no toxic petroleum solvents, & the surfactants used are biodegradable.

Part Number	Size
P902-1001A	1 GAL (3.8 liters)

### Internal Coil Cleaner



**Features:**

- Cleans interior lines in air conditioning and refrigeration systems after compressor burnout or prior to new installation.
- Breaks down carbon deposit, tar sludge, oil, grease & neutralizes acids in systems.
- Environmentally sound replacement for R11, R12 and chlorinated solvents.
- Does not contaminate refrigerant or oil, contains no CFCs, leaves no residue.
- Biodegradable.

Part Number	Size
P902-1601	1 GAL (3.8 liters)

### Condenser Cleaner Non-Acid Super Concentrate



**Features:**

- Non-acid super concentrate is formulated with twice the active ingredients insuring a much more versatile cleaner with multiple dilution rates for cleaning applications.
- Non-acid super concentrate is non acid for improved user safety and yet produces excellent foaming action, superior cleaning, even on greasy surfaces and effectively brightens aluminum this one versatile product allows the user to efficiently and economically clean virtually any component of the a/c system.

Part Number	Size
P902-0101B	1 GAL (3.8 liters)

### Non-Acid Total Bright Condenser Cleaner And Brightener



**Features:**

- Brightens better than typical alkaline products.
- Foams out stubborn deposits from air cooled condensers.
- Ideal for cleaning and brightening grease contaminated air conditioning condensers.

Part Number	Size
P902-0101A	1 GAL (3.8 liters)

# TOTALINE® CHEMICALS

## Chemicals - Coil Cleaners

### Environmentally Sound Coil Cleaner



Safely cleans both evaporator and condenser coils without potential damage to equipment, personnel or the environment. Unlike strong acid or highly alkaline cleaners that actually eat away a thin layer of aluminum to remove contamination, it attacks only the dirt build up and leaves metal surfaces clean and free of corrosion.

Part Number	Size
P902-0301	1 GAL (3.8 liters)
P902-0305	6 GAL (22.7 liters)
P902-0355	55 GAL (208.2 liters)

### Outdoor Condenser Cleaner Concentrate



**Features:**

- Foams out stubborn deposits from air cooled condensers
- Reduces head pressure
- Increases system capacity
- Only equipment required is plastic or other acid-resistant hand-type sprayer

Part Number	Size
P902-0501	1 GAL (3.8 liters)
P902-0505	6 GAL (22.7 liters)
P902-0555	55 GAL (208.2 liters)

### Outdoor Coil Cleaner Base, Super Concentrated



No extra water added...100% cleaning ingredients. Non-acid formula with foaming action to clean even the most greasy surfaces. Dilute with water for use on air-cooled condensers, evaporators, and electronic filters.

Part Number	Size
P902-0104	32 oz. (.95 liters)
P902-0104-55	55 GAL (208.2 liters)

### Indoor Coil Cleaner Base, Super Concentrated



This self-rinsing base effectively cleans evaporators, removes mold, dust, and greasy residue. Concentrated, you just add water. No rinsing required.

Dilution Rate = 24 parts water

Part Number	Size
P902-1004	32 oz. (.95 liters)

## Chemicals - Other Cleaners

### Electronic Air Cleaner Concentrate



Easily removes grease, soot, grime, oil, tobacco tars, wax, carbon, gummy dust, and many other stubborn deposits.

- Electronic air filters
- Permanent filters
- Air ducts and grills
- Heating parts
- Fan blades and blowers
- Refrigeration parts
- USDA accepted

Part Number	Size
P902-2001	1 GAL (3.8 liters)

### Scale Remover (Low Foaming)



**Features:**

- Safely removes scale, heavy slime and algae from: cooling towers, condensers, and pipes
- Reduces head pressure
- Increases system capacity
- Reduces power consumption
- Labor saving

Part Number	Size
P902-2501	1 GAL (3.8 liters)
P902-2505	6 GAL (22.7 liters)
P902-2555	55 GAL (208.2 liters)

### Scale Remover With pH Indicator



Eliminates the tedious and time consuming necessity of constantly checking the activity of the cleaning solution with ph paper.

Part Number	Size
P902-2601	1 GAL (3.8 liters)
P902-2605	6 GAL (22.7 liters)

# TOTALINE® CHEMICALS

## Chemicals - Other Cleaners

### Ice Machine Cleaner (Metal Safe)



A non-foaming metal safe ice machine cleaner. safe to use on all types of ice machines including those with nickel plated drums.

- Meets Manitowoc's specification GES-6.
- USDA accepted.

Part Number	Size
P902-1508	8 OZ (.24 liters)
P902-1501	1 GAL (3.8 liters)

### Degreasing Solvent



Non-chlorinated full strength that combines cleaning effectiveness with personal safety and environmental concerns. Slow evaporating. Contains no toxic substances as defined by SARA Title III, Section 313.

Part Number	Size
P902-3002	1 GAL (3.8 liters)
P902-3002-055	55 GAL (208.2 liters)

### Solvent Cleaner And Degreaser



Removes oil, grease and grime from mechanical parts, sheet metal, switches, motor armatures, etc. Spray, soak or brush parts. Controlled evaporation ensures deep soil penetration for effective cleaning. Non-chlorinated, high flash point (140° F), pleasant citrus scent.

Part Number	Size
P902-1301	1 GAL (3.8 liters)
P902-1325*	32 oz. (.95 liters)

\*Spray Bottle

### Total 9 Buffered ph Cleaner, Concentrate



Concentrated all purpose cleaner, formulated to quickly remove grease and heavy soils. Cleans any washable, nonporous surface. Environmentally friendly, safer to use alternative to bleaches, solvents and toxic cleaners. Excellent in parts washers. Ideal formulation for use on HVAC equipment, appliances, boat, truck, RV exteriors. Easily cleans glass and stainless steel.

Part Number	Size
P902-1701	1 Gal (3.8 liters)

## Chemicals - Protectors, Inhibitors and Sanitizers

### Winter Corrosion Protector



Protects interior of chilled water systems that have been drained for winter lay-up. Spring start-up labor and equipment deterioration are greatly reduced by the prevention of corrosion and rust in the system.

Part Number	Size
P902-5005	6 GAL (22.7 liters)

### One Shot Scale And Corrosion Inhibitor



#### Features:

- Multifunctional liquid cooling water treatment
- Keeps recirculation cooling water in a buffered alkaline state.
- Inhibits microbiological growth and maintains water quality

Part Number	Size
P902-5501	1 GAL (3.8 liters)
P902-5505	6 GAL (22.7 liters)
P902-5555	55 GAL (208.2 liters)

### Coil And Duct Sanitizer Spray



EPA registered as a bacteriostat, fungistat, germistat and all purpose deodorizer for use on HVAC systems (including duct work and evaporator coils). Controls microorganism growth and eliminates odors caused by their growth. Easy to use. Clean the area and thoroughly spray all parts. Environmentally safe.

Part Number	Size
P902-3601	1 GAL (3.8 liters)
P902-3632*	32 oz. (.95 liters)

\*Spray Bottle

### Algeacide

A quaternary ammonium chloride formulation that quickly destroys algae and slime to improve cooling system performance. Noncorrosive, safe on wood, metal and plastics. Non-foaming, non-volatile.

Part Number	Size
P902-3501	1 GAL (3.8 liters)

# TOTALINE® CHEMICALS

## Chemicals - Protectors, Inhibitors and Sanitizers

### System Sanitizer, Concentrated



EPA registered specifically for HVAC and air duct sanitation and deodorization. Concentrated and easily applied with the use of a hand held fogger or air driven sprayer to mist through a pre-cleaned system. No rinsing is required. Effective against a broad spectrum of microorganisms. No toxic chemical residue or odors.

Part Number	Size
P902-3704	3.25 oz. (96ml)

### Fin Protectant



FIN Protectant is a specially formulated coating containing acrylic polymers and anti-corrosion agents designed to protect painted or unpainted metals from rust and corrosion. FIN Protectant seals and protects aluminum, copper, brass, bronze, chrome, galvanized metal, titanium, and stainless steel. It is ideally suited for use on air cooled condensers located in corrosive environments such as airports, adjacent to freeways, and salt air areas. Recommended for use with P902-0101 Condenser Cleaner.

Part Number	Size
P902-5101	1 GAL (3.8 liters)
P902-5116	16 oz (454 gr) aerosol can

### Other Chemicals

#### Flame Retardant



Inhibits the spreading of flames on natural fiber materials. Non-hazardous and easy to use, it will not retard and synthetic, metal, plastic, or other man-made or previously treated material.

Part Number	Size
P902-3232	32 oz (.95 liters)

### Leak Reactant



Totaline Leak Reactant provides a quick and easy way to pinpoint gas leaks from any pressurized gas system. Thick, tacky fluid clings to surfaces — even the underside of pipes, and instantly produces an easy to see, long lasting stream of bubbles.

- Quart size spray bottles include heavy duty adjustable trigger sprayer
- Available in one gallon size refills non-clogging, non-hazardous, non-corrosive, biodegradable formulation.

Part Number	Size
P902-1432	1 QT (.95 liters)
P902-1401	1 GAL (3.8 liters)

### Gas Leak Locator



#### Features:

- Large leaks bubble up immediately
- Slow, small leaks bubble up within a few seconds

Part Number	Size
P902-4508	8 OZ. (.24 liters)
P902-4501	1 GAL (3.8 liters)

### Wasp And Hornet Spray



#### Features:

- Dielectric strength over 40,000 v/cm
- long spray pattern up to 20 feet aid in reaching nests
- 16 oz. Can (454 grams)

Part Number
P902-4016

### Totaline® Chemical Accessories

#### Trigger Spray With Extension Tube

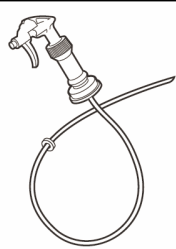

A heavy duty trigger sprayer with a 24" extension tube and cap.

- Easily attaches directly to a one gallon bottle

Part Number
P902-9000



# TOTALINE® CHEMICALS

## Totaline® Chemical Accessories

### One Quart Spray Bottle

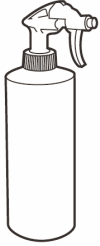

Designed especially for smaller jobs. Heavy duty, handy trigger

Part Number
P902-9001

### Tank Sprayer

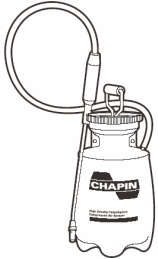

High quality plastic pressure sprayer with funnel top for easy filling. Reinforced 36" (91 cm) hose and 12" (30 cm) poly/brass wand with adjustable spray head.

Part Number	Size	Operating Capacity
P902-9002	2 GAL (7.56 liters)	1-1/2 GAL (5.67 liters)
P902-9015	1-1/2 GAL (5.67 liters)	1 GAL (3.8 liters)

### Foam Cleaning Fluid & Foam Cleaning Gun



#### Features:

- Formulated to clean coils
- Gun attached to garden hose and applies cleaning solution at proper dilution

Part Number	Size
P902-0201	1 GAL (3.8 liters)
P902-0206	6 GAL (22.7 liters)
P902-0255	55 GAL (208.2 liters)
P902-9003	Foam Fluid Gun

### Chemical Fogger

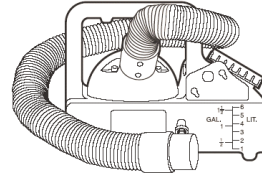

The Totaline P902-9016 Chemical Fogger is used for applying sanitizers, disinfectants, and deodorizers. Excellent for these effective

Totaline products:

Totaline Coil and Duct Spray: (P902-3601, P902-3632)

Totaline System Sanitizer: (P902-3704)

Total Fresh Odor Neutralizer: (Liquid P902-39004, P902-39008)

- 1-1/2 gallon, durable, one-piece, seamless tank
- 3-1/2" opening for easy filling
- Versatile 48" Flex hose
- Adjustable flow from 0-18 oz/min
- 110v/60Hz, 2-stage motor
- Constructed entirely of corrosion-resistant materials
- Dispenses materials (water based, room temperature) at average droplet size from 20 to 80 microns
- Easy clean-up

Part Number
P902-9016

### Totaline® Condensate Drip Pan Cleaner



#### Features:

- EPA registered.
- Water Activated.
- Time released control of microbial contaminants.
- Reduces foul odors, drain stoppages, corrosion and promotes system hygiene.
- Kills mold, algae, fungus, legionella bacteria and other micro-organisms.
- High capacity lasts up to 6 months.

Part Number	Size	Unit Application
P902-38001	4 x 3/4 x 1/4	Window / Fan and Coil (Bulk Pkg. 20 Strips)
P902-38002	4 x 3/4 x 1/4	Window / Fan and Coil
P902-38003	5 x 1-1/4 x 1/4	Up to 2.5 Tons
P902-38004	12 x 1-1/2 x 1/4	3 - 5 Tons
P902-38005	12 x 1-1/2 x 5/8	6 - 10 Tons
P902-38006	12 x 3 x 5/8	Up to 20 Tons
P902-38007	24 x 3 x 5/8	40 - 50 Tons

# TOTALINE® CHEMICALS

## Total Tabs For Condensate Drain Pans



**Features:**

- Safe, easy to use, and completely soluble.
- Formulated with the compound at-8, are non-toxic and noncorrosive.
- Clean sludge, scum, and other accumulations in condensate pans preventing odors caused by these accumulations.

Part Number	Size
P902-42001	100 TABS

## Totalfresh II Odor Neutralizer



- New pleasant scent, white colored.

Part Number	Description
P902-39009	1/2 lb tub
P902-39010	1 lb tub
P902-39011	3 lb tub

## Totalfresh Odor Neutralizer

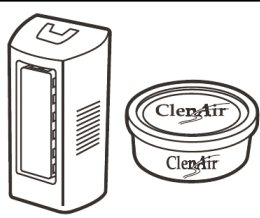

**Features:**

- Eliminates odors and air contamination.
- Inhibits the growth of certain molds and bacteria.
- Solid gel which is basically odorless after 12 hours.
- Draws the smell out of the air to give you a clean and healthful atmosphere.
- Light odor—1/2 to 1 lb/400 sq ft.
- Medium odor — 2 lbs/400 sq ft.
- Heavy odor — 3 to 4 lbs/400 sq ft.
- Aqua color. Use 3 lb tubs in central air return ducts.

Part Number	Description
P902-39001	1/2 lb tub
P902-39002	1 lb tub
P902-39003	3 lb tub
P902-39004	16 oz spray bottle (citrus scent)
P902-39005	30 lb pail
P902-39006	1 lb blocks for wall unit
P902-39007	Wall unit with 6 blocks
P902-39008	16 oz spray bottle (unscented)

# TOTALINE® CHEMICALS

## Touch-Up Paint



Touch-up Spray Paint comes in 16 ounce cans, ideal for various touch-up jobs. All paint labels meet O.S.H.A. requirements and Federal Safety Codes.

Part Number	Paint Color	Series Used On
PH23JA012	Gloss Ivory	Misc.
PH23WL012	Alpine Mist	28, 400B, OH
PH23GH018	Parchment	36R,S, 42A,B, 50BQ
PH23ZS016	Silver Sage	28, 34, 58, 40, 31. 49, 350, 355, 58MXA, 58MVP, 394C, 58WAV, 376C, 58ZAV
PH23GH019	Fawn Beige	51
PH23FS010	Sand Beige	50BT, BU
PH23NB015	Malibu Beige	58ES
PH23PE023	Silver Grey	38CQ, EC, UE, TO, HO, TE, RQ, RE, QW, QF, VE, VH, VJ, VT, QB
313974-751	Dark Grey	TECH 2000
313974-752	Light Grey	TECH 2000
313974-754	Sand Piper Beige	Reliant/Endura S/S
313974-755	Kona Black	Cond Coils
313974-756	Swiss Mosha Brown	Cobra, Eventemp S/S
313974-757	Gray Mist	Furnace Prod after 9/95 Models 373LAV, 383KAV, 58RAV, 58PAV, GB1AAV, GB3AAV
PH23GL012	Sea Spray Green	Misc. 38, 48, 50, 58, 38GR, CB, CC
PH23VS016	Vista Green (Dull Finish)	CE,EA,EB,SE, EE
PH23VS017	Vista Green (High Gloss)	38GR, CB, CC, CE
PH23GH020	Pale Green	38GF, 40GC
PH23PC016	Medium Green	38CU
PH23GH017	Horizon Green	19D,C
PH23TZ150	Midnight Blue	58SE
38UE680007	Blue (for coils)	38VE, VH, VJ, VT,UE
PH23US016	Burgundy (for coils)	38CO, RQ
PH23RZ016	Chocolate Brown	58SE
PH23FH010	Chocolate Brown	58HK, HM, HS, HW
PH23RZ010	Chocolate Brown	50BT, BU
PH23SS012	Chestnut Brown	38EC, ED
38LE680001	Light Green	--
42CA680215	Parchment Beige	--
48KH33178DP23	Dark Green	--
PH23SG016	Grey Metallic	--
42CA680221	Champagne Beige	--
37AE680001	White Acrylic Enamel	--