

## C165+

Residential/Commercial Combustion Analyzer

INSTRUCTION MANUAL

ENGLISH

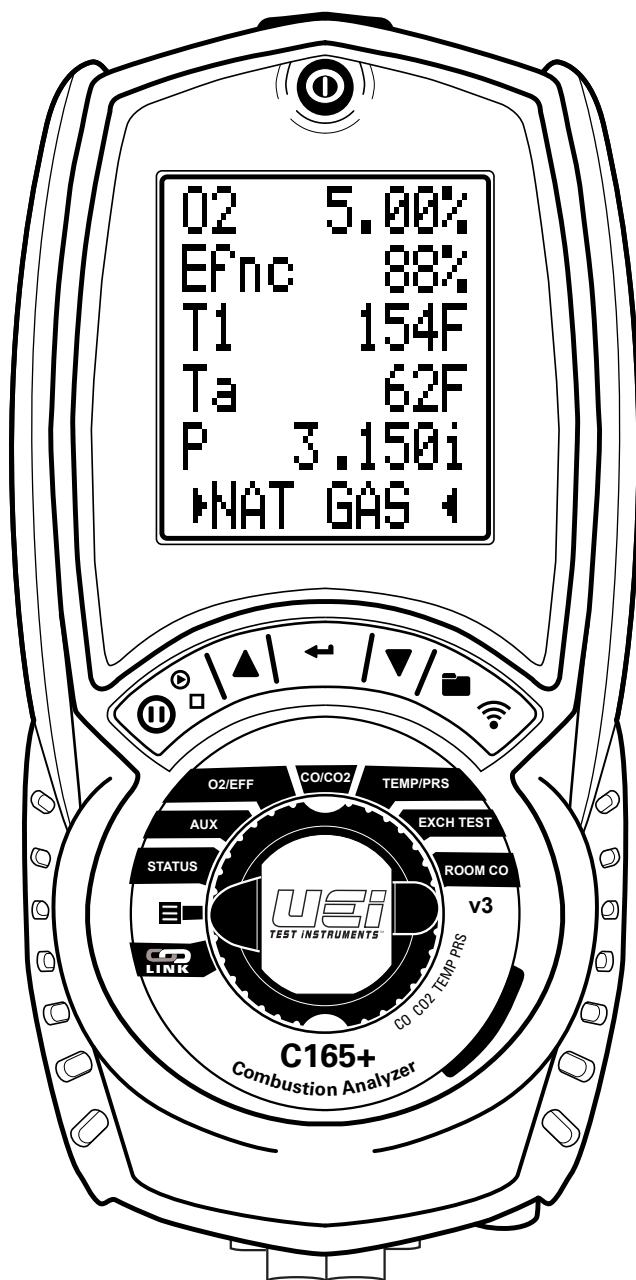

BACKED BY

UEI  
SERVICE+

**10**  
YEAR  
WARRANTY



RoHS  
Compliant

REACH  
Compliant



## TABLE OF CONTENTS

<p><b>Functions</b> ..... 2</p> <p><b>Features</b> ..... 2</p> <p><b>General Specifications</b> ..... 3</p> <p><b>Important Safety Warnings</b> ..... 3</p> <p><b>Symbols</b> ..... 4</p> <p><b>Analyzer Overview</b> ..... 4-5</p> <p><b>Overview</b> ..... 6</p> <p><b>Pre Test Checklist</b> ..... 7</p> <p><b>Setting Inlet Temperature</b> ..... 7</p> <p><b>Analyzer Connections</b> ..... 7</p> <p><b>Emptying &amp; Cleaning the In-Line Water Trap</b> ..... 7</p> <p><b>Changing The Particle Filter</b> ..... 7</p> <p><b>Quick Start</b> ..... 7</p> <p><b>Fresh Air Purge</b> ..... 8</p> <p><b>CO Over-range Protection Pump</b> ..... 8</p> <p><b>Measuring Flue Gases</b> ..... 8</p> <p><b>Using The Menu</b> ..... 9-11</p> <p><b>Combustion Test</b> ..... 11-12</p> <p style="padding-left: 20px;"><b>- Optional Nitric Oxide Sensor</b> ..... 11</p> <p><b>Heat Exchange Integrity Test</b> ..... 12</p> <p><b>Room CO Test</b> ..... 12</p> <p><b>Printing</b> ..... 14</p> <p><b>Printouts</b> ..... 14</p> <p><b>iOS App Guide</b> ..... 15</p> <p style="padding-left: 20px;">Kane Wireless Printer App Home iOS Screen ..... 15</p> <p style="padding-left: 20px;">Kane Wireless Printer App Settings Screen ..... 15</p> <p><b>Android App Guide</b> ..... 16</p> <p style="padding-left: 20px;">Kane Wireless Printer App iOS Settings Screen ..... 16</p> <p style="padding-left: 20px;">Kane Wireless Printer App Android Settings Screen ..... 16</p> <p style="padding-left: 20px;">Kane Wireless Printer App Android Personal Details Screen ..... 16</p> <p><b>Temperature Testing</b> ..... 17</p>	<p><b>Temperature/Pressure Testing</b> ..... 17</p> <p><b>Pressure Measurement Good Practice</b> ..... 17</p> <p><b>Large Bore Tubing Issues</b> ..... 17</p> <p><b>Analyzer Specification</b> ..... 18-19</p> <p><b>Certification</b> ..... 19</p> <p><b>Electromagnetic Compatibility</b> ..... 19</p> <p><b>Where To Test</b> ..... 20-21</p> <p><b>What Results Are Generally Acceptable</b> ..... 21</p> <p><b>Powering Off</b> ..... 22</p> <p><b>Post Test</b> ..... 22</p> <p><b>General Maintenance</b> ..... 22</p> <p><b>Cold Weather Precautions</b> ..... 22</p> <p><b>Replacing The Batteries</b> ..... 23</p> <p><b>Annual Recertification</b> ..... 23</p> <p><b>Recertification Services</b> ..... 24</p> <p><b>Returning Your Analyzer</b> ..... 24</p> <p><b>Where To Send Your Analyzer</b> ..... 24</p> <p><b>Other Important Factors Relating To Combustion</b> ..... 25</p> <p><b>Combustion Measurement Terms</b> ..... 25</p> <p><b>Disposal</b> ..... 26</p> <p><b>Storage</b> ..... 26</p> <p><b>End Of Life Disposal</b> ..... 26</p> <p><b>Warranty</b> ..... 26</p>
---	---

### FUNCTIONS

- |  |  |
|--|--|
| <ul style="list-style-type: none"> <li>• <b>Flue temperature:</b> 32° to 1112°F</li> <li>• <b>Inlet temperature:</b> Internal/ External sensor 32° to 112°F</li> <li>• <b>O<sub>2</sub>:</b> 0 - 21%</li> <li>• <b>CO:</b> 10,000ppm</li> <li>• <b>CO<sub>2</sub>:</b> 0 - 20 %</li> </ul> | <ul style="list-style-type: none"> <li>• <b>Efficiency:</b> Nett/Gross 99.9%</li> <li>• <b>Efficiency:</b> High (calculated) 119.9%</li> <li>• <b>Excess air:</b> 250%</li> <li>• <b>CO/CO<sub>2</sub> ratio:</b> 0.99%</li> <li>• <b>Differential pressure</b></li> </ul> |
|--|--|

### FEATURES

- |   |   |
|---|---|
| <ul style="list-style-type: none"> <li>• <b>EOS Technology</b></li> <li>• <b>Pre-programmed fuels:</b> Nat Gas, H Oil, Pellets, L Oil, LPG, Butane, Propane, Town Gas, Coke Gas, Bio Gas, Bio Fuel</li> <li>• <b>Memory Positions:</b> 45</li> <li>• <b>6 line backlit display</b></li> </ul> | <ul style="list-style-type: none"> <li>• <b>High altitude compensation</b></li> <li>• <b>User customizable parameter views</b></li> <li>• <b>Individual report printouts</b></li> <li>• <b>Real-time clock</b></li> </ul> |
|---|---|

## GENERAL SPECIFICATIONS

- **Operating Temperature:** 32° to 112°F (0° to 45°C)
- **Storage Temperature:** 0° to 120°F (-18° to 50°C)
- **Operating Humidity:** 10% to 90% R.H.
- **Back light:** Yes
- **Dimensions:** 7.87 x 1.77 x 3.5 inch
- **Item Weight:** 1.375 lbs
- **Calibration:** Recommended Annually
- **Certification:** CE Conformity, RoHS, REACH Compliant, AHRI 1260 standard, FCC
- **Battery Size:** Alkaline or NiMH AA 3
- **Accuracy:** ± (% of reading + # of least significant digits)

## IMPORTANT SAFETY WARNINGS

 Read entire Safety Notes section regarding potential hazard and proper instructions before using this analyzer. In this manual the word “**WARNING**” is used to indicate conditions or actions that may pose physical hazards to the user. The word “**CAUTION**” is used to indicate conditions or actions that may damage this instrument.

### **WARNING**

To ensure safe operation and service of the tester, follow these instructions. Failure to observe these warnings can result in severe injury or death.

### **WARNING**

- Do not use this analyzer during electrical storms or in wet weather.
- To avoid false readings, charge batteries if a low battery indicator appears.
- Always adhere to national and local safety codes. Use proper personal protective equipment (PPE)

### **WARNING**

This analyzer extracts combustion gases that may be toxic in relatively low concentrations. These gases are exhausted from the back of the analyzer.

***This analyzer must only be used in well-ventilated locations by trained and competent persons after due consideration of all potential hazards.***

Users of portable gas detectors are recommended to conduct a “bump” check before relying on the unit to verify an atmosphere is free from hazard. A “bump” test is a means of verifying that an instrument is working within acceptable limits by briefly exposing to a known gas mixture formulated to change the output of all the sensors present.

***NOTE: This is different from a calibration where the instrument is also exposed to a known gas mixture but is allowed to settle to a steady figure and the reading adjusted to the stated gas concentration of the gas of the test gas.***

## SYMBOLS

	Low Battery	°F	Degrees Fahrenheit
°C	Degrees Celsius		Menu
	LINK		Pump Off & Pump On
	Pump Start		Pump Stop
	Navigate Down		Navigate Up
	Enter Key		Wireless/Store/Print

## ANALYZER OVERVIEW

### A. Infrared Printer Port

### B. On/ Off (Power) Button

### C. 6 Line Backlit Display

- Press any button to turn Back light on.

### D. Pump Toggle Button: short press is data hold, long press turns pump on and off

### E. UP Button

- Short press to navigate "UP"

### F. Wireless/Store/Print Button: short press print, long press store

### G. Down Button:

- Short press to navigate "DOWN"

### H. ENTER Button: short press works as enter, long press turns on work light

### I. Rotary Dial

### J. Particle Filter (inside water trap)

### K. Water Trap

### L. LED Water Trap Indication

### M. Protective Rubber Boot with Magnets

### N. Serial Number QR Code: (Serial Number viewable under Protective Boot)

### O. Sensors Fitted: (label under Protective Boot) Sensors that can be fitted in unit when shipped (CO-H2, CO, CO2, NO, O2)

### P. Battery Compartment: (under Protective Boot)

### Q. Grip Indentation: Indentation for fingers to grip analyzer

### R. Water Trap Drain Plug (Red plug; take caution NOT to damage plug when removing protective boot)

### S. Battery Charge USB Adapter Connection

### T. Temperature Connections

- Flue Probe Temperature: T1
- Inlet Temperature: T2

### U. Flue Gas Inlet Connection

### V. Pressure Connections

- Pressure: P1
- Differential Pressure: P2

### W. Infrared Printer Port

**ANALYZER OVERVIEW (CONT.)**

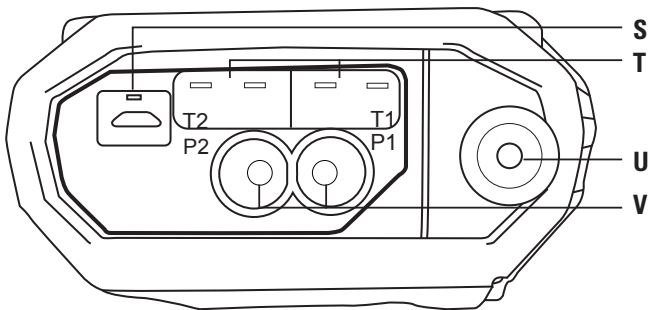
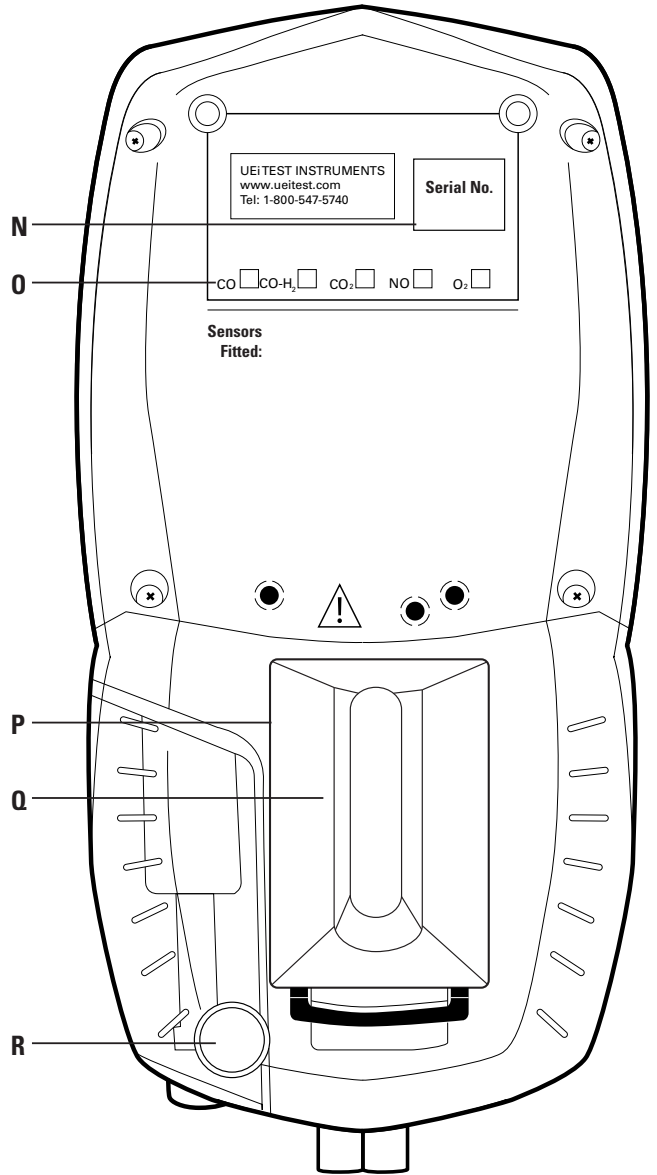
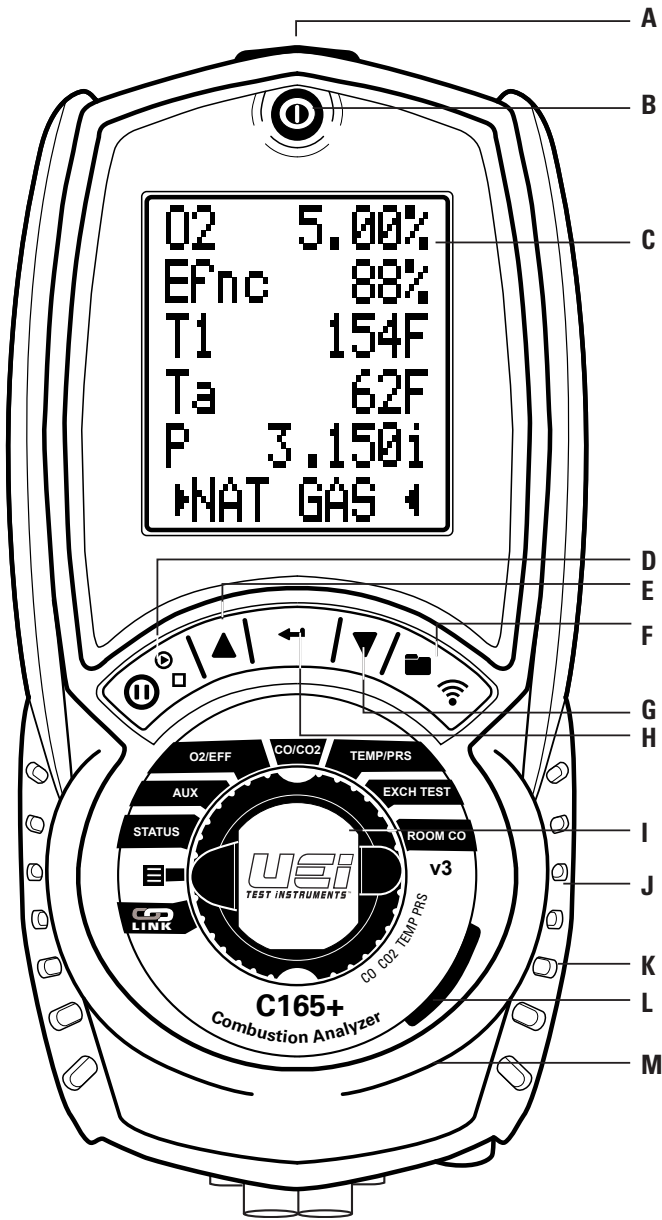

[BOTTOM]

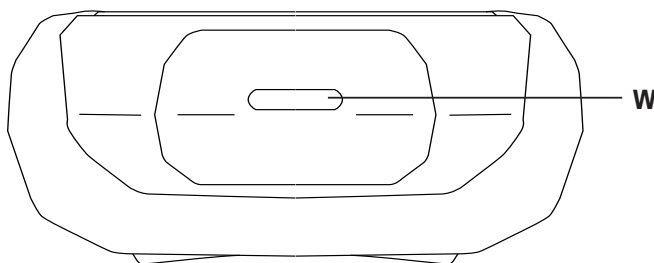

[TOP]

*Narrow Pin MUST be on the Right hand side.  
Flue Probe Temperature Plug*

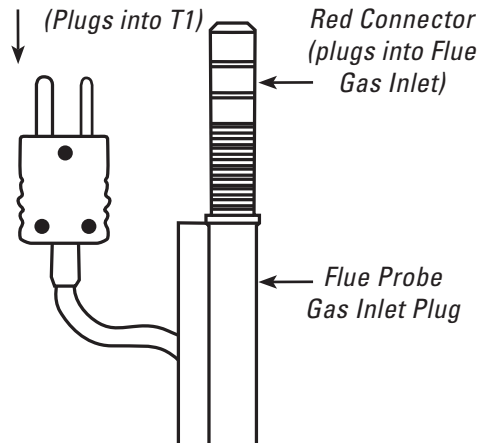

## OVERVIEW

The C165+ Combustion Analyzer measures CO, CO<sub>2</sub>, differential temperature and differential pressure.

CO<sub>2</sub> is set to zero in fresh air automatically after the initial countdown.

It is important that re-zeroing is done in outside fresh air as indoor CO<sub>2</sub> levels are affected by human breath. It calculates oxygen (O<sub>2</sub>), CO/CO<sub>2</sub> ratio, Losses, Combustion Efficiency (Gross, Nett, Gross Condensing, or Nett Condensing).

The C165+ Combustion Analyzer can also measure CO levels in ambient air - useful when a CO Alarm is triggered. It can also perform a Room CO Test for 30 minute duration.

A low flow detection system warns of low flow and switches the pump off. This also helps to prevent water ingress from overfilled water traps.

The analyzer has a protective rubber boot with magnets for hands-free operation and is supplied with a probe with an integral temperature sensor.

A large 6 line display provides the user with relevant information. All data can be printed via the infrared printer or Wireless Printer App.

The C165+ uses a new data storage system allowing the user to store the maximum number of logs of interest to them, rather than be restricted to an allowance of particular logs.

The memory can store up to 45 logs of any combination of Combustion, AUX, Temperature, Heat Exchange, Room CO.

## PRE TEST CHECKLIST

- Clean particle filter
- Water trap and probe line are empty of water
- Power on and zero
- All hose and thermocouple connections are properly secured
- Flue gas probe is sampling ambient FRESH air
- Water trap is fitted correctly to the instrument
- Flue temperature plug is connected
- Ensure water trap plug is inserted correctly

## SETTING INLET TEMPERATURE

- Turn on and zero the analyzer, without the flue probe connected, to use ambient temperature
- Connect the flue probe thermocouple to T1 during zero countdown use for inlet ducted system
- Connect a thermocouple to T2 to measure second temp source

## ANALYZER CONNECTIONS

### ⚠ WARNING

Turning the pump off while the probe is in the flue will leave toxic gases inside the analyzer. Once data has been printed or copied, it is advisable to purge the unit with fresh air as soon as possible. To do this remove the probe from the flue and turn ON pump. Always allow the readings to return to zero (20.9% for O<sub>2</sub>) prior to shutting the unit off. The meter will not switch off until the CO reading is below 20 ppm.

### ⚠ CAUTION

The probe will be hot from flue gases. Remove the probe from the flue and allow it to cool naturally. Do not immerse the probe in water, as this will be drawn into the analyzer and damage the flue probe and the pump and sensors.

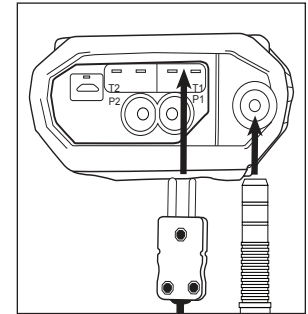

**NOTE:** Take care when inserting the temperature probes as the pins are polarized. Insert with the smaller pin (+) to the right.

## EMPTYING & CLEANING THE IN-LINE WATER TRAP

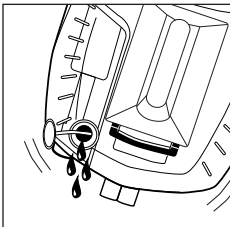

- Remove the rubber plug
- Allow the water to drain out
- Re-insert the rubber plug

## CHANGING THE PARTICLE FILTER

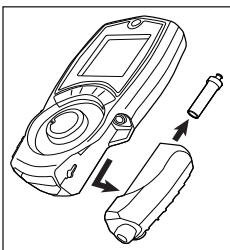

- Remove the protective rubber boot
- Slide the water trap unit from the analyzer
- Remove the particle filter from its' spigot and replace
- Slide the water trap back into position and replace the protective rubber boot

## QUICK START

Turn on the analyzer by pressing the On/Off Button for 2 seconds until the unit activates. As described the analyzer will perform a 60 second turn on purge. Once completed simply select the reading desired by the position of the rotary dial.

## FRESH AIR PURGE

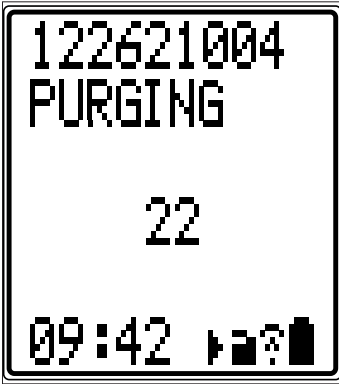

### NOTE

Each time the analyzer is turned on it will perform a 60 second air purge, this is to clear the gas sampling path (including probe, if connected). For these reasons it is very important that the analyzer be in **outside fresh air** when powered on.

## CO OVER-RANGE PROTECTION PUMP

The analyzer's intelligent protection system will automatically activate the protection pump once an over-gas condition is detected (see specification table for detection limits). When activated the main sampling pump will be shut down, allowing the sample system to be purged with fresh air. Once readings have returned to a safe level, the protection pump will shut down and the main pump will reactivate.

## MEASURING FLUE GASES

After the initial countdown is finished and the analyzer is properly setup, put its' flue probe in the appliance's sampling point. The tip of the probe should be at the center of the flue. Use the flue probes depth stop cone to set the position. With balanced flues, make sure the probe is positioned into the flue so no air can "back flush" into the probe.

**CAUTION!:** Ensure the flue probe handle does not get hot!

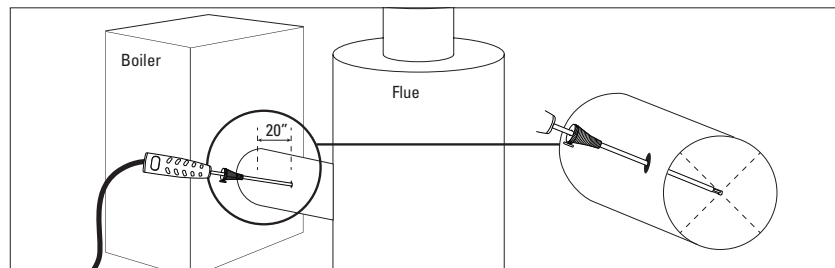



## USING THE MENU

Select "Menu" on the rotary switch and navigate using the function buttons:

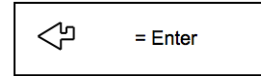
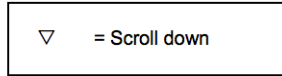
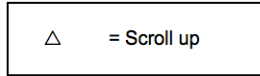

**NOTE:** To "EXIT" the "MENU" at any time simply move the rotary switch to any position other than "Menu". Any changes that have not been "entered" will be ignored.

MENU SCREEN		
	MENU	OPTIONS/COMMENTS
	LOGS	VIEW, EXIT, DELETE ALL
	CODE	000000 (PASSWORD PROTECTED FOR AUTHORIZED SERVICE PERSONAL ONLY)
	TIME	HH:MM:SS
	DATE	MM:DD:YY
	HEADER	LINE 1, LINE 2, BACK
	IR PRINT	KMIRP, IRP-2/3
	°C/°F	°C or °F
	GAS UNIT	ppm, mg/kWh, mmg/m3
	LANGUAGE	ENGLISH, FRANCAIS, ESPANOL
	EFF	GROSS, NETT
	O2 REF	CO %

The Menu position on the Rotary Dial allows for the customization of the default settings for the analyzer as per the user's requirements. Navigation through the Menu system is via the dedicated user's interface buttons (Up, Down, Enter).

As you navigate up or down through the Menu, the items will scroll accordingly, eventually back to the beginning.

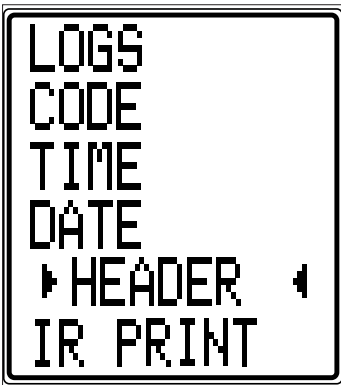

Rotate Selector Dial to **MENU** to set up or customize your settings.

Selected parameter are centered, highlighted with arrow icons on either side.

Use ▲ and ▼ buttons to scroll menu options.

Press ← to a select a parameter to edit. Press ← button to scroll fields to change.

Press ▲ and ▼ buttons to change field contents.

Press → to enter content selected.

The analyzer will perform a 60 second purge in Rotary Dial setting of AUX, O2/Eff, CO/CO2. This should be done in fresh air.

## COMBUSTION TESTS

Insert the tip of the flue probe into the center of the flue. The readings will stabilize within 60 seconds assuming the system conditions are stable.

The rotary switch can be used to display the following information:

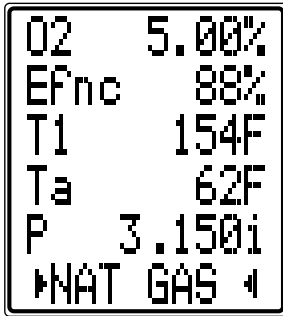

### O2/Eff



O2 5.00%  
EFnc 88%  
T1 154F  
Ta 62F  
P 3.150i  
▶NAT GAS◀

Fuel type can be changed via "STATUS" setting.  
Carbon Dioxide (%)  
Oxygen (%) left after combustion. Should be 20.9% ± 0.3% in fresh air.  
Gross efficiency  
Flue temperature (°F).  
Inlet temperature (°F). Normally set by flue probe during fresh air purge.

Press   to print a full combustion test, (or send to Smart Device via optional Wireless module).

Hold   for 2+ seconds to log a full combustion report.

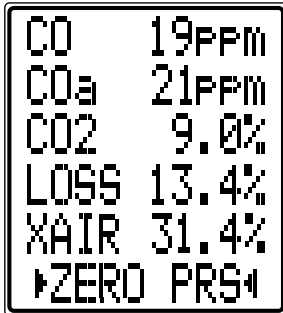

### CO/CO2



CO 19PPM  
COa 21PPM  
CO2 9.0%  
LOSS 13.4%  
XAIR 31.4%  
▶ZERO PRS◀

Fuel type can be changed via "STATUS" setting.  
Carbon monoxide (ppm).  
COa is CO Air Free  
Losses calculated  
Excess air %  
Pressure reading

Press   to print a full combustion test, (or send to Smart Device via optional Wireless module).



Hold   for 2+ seconds to log a full combustion report.

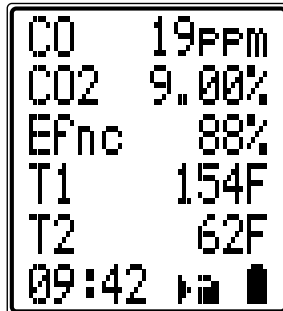

### AUX display



CO 19PPM  
CO2 9.00%  
EFnc 88%  
T1 154F  
T2 62F  
09:42 ▶ 

The AUX (auxiliary) display can be customized via "MENU" / "SCREEN" / "AUX".  
The parameters displayed on lines 1, 2, 3, 4 and 5 can be set by the user.  
They remain the AUX parameters until changed by the user.

Press   to print a full combustion test, (or send to Smart Device via optional Wireless module).

Hold   for 2+ seconds to log a full combustion report.

## COMBUSTION TEST - OPTIONAL NITRIC OXIDE SENSOR

### Instructions for C165+ Analyzers fitted with optional Nitric Oxide (NO) sensors

#### Displaying the Nitric Oxide (NO) reading

Select "Menu" on the rotary switch and navigate using the function buttons:

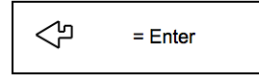
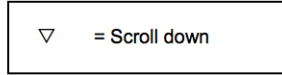
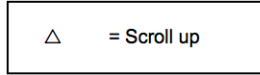

Select SCREEN and then select AUX

Choose a line to display the required readings as below

#### AUX display

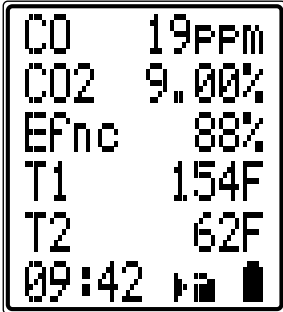

The AUX (auxiliary) display can be customized via MENU / SCREEN / AUX. The parameters displayed on lines 1, 2, 3, 4, 5 and 6 can be set by the user. They remain the AUX parameters until changed by the user.

**NOTE:** To EXIT the MENU at any time simply move the rotary switch to any position other than MENU. Any changes that have not been "entered" will be ignored.

Use ▲ and ▼ to navigate to the main menu option SCREEN Press ←.

Use ▲ and ▼ to navigate to the sub menu option AUX Press ←.

#### PRINTING and STORING

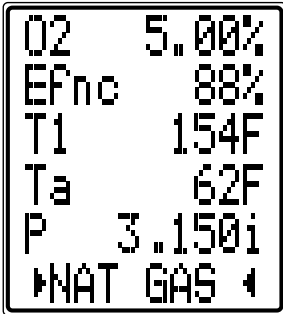

The NO readings are printed and stored in the same way as the other combustion gas readings. On the printouts the NO readings appear directly below the flue CO readings or AUX

The dial needs to be in O2/Eff, CO/CO2 or AUX position to print or store. When the dilution pump is operating to protect the CO sensor the NO readings are also affected by an unspecified amount. The screen typically will show: ----

## HEAT EXCHANGE INTEGRITY TEST

There are many methods to test heat exchange integrity. One of these is to observe the Excess Air, O<sub>2</sub> and CO readings both before and after the blower turns on. If the heat exchanger is sealed, your O<sub>2</sub> and CO readings should remain fairly stable. A breach in the heat exchanger may allow fresh air to be forced into the flue after the blower turns on due to pressure increase in the plenum. The result may be a rise in the measured O<sub>2</sub> in the stack gas and an increase in Excess Air. In some sealed systems the fresh air drawn in through the breach may reduce the combustion air available leading to an increase in the CO reading. If either of these situations are present it is probable there is a problem with the Heat Exchanger which may require additional testing and inspections.

**NOTE:** Many cracks are invisible to borescopes or the naked eye, and only open or separate from pressure or temperature changes during operations. Rotate dial to "EXCH TEST" Rotate test selector to "EXCH TEST". Call for heat on the system. Observe and wait for O<sub>2</sub> readings to stabilize.

```
EXCHANGE
MEM. 1/30
▶ RUN ◀
```

```
EXCHANGE
TEST
▶ START ◀
```

```
SETUP
FUEL TYPE
▶ NAT GAS ◀
```

```
CO 19PPM
COa 21PPM
CO2 9.0%
LOSS 13.4%
XAIR 31.4%
▶ ZERO PRS◀
```

```
CO 19PPM
COa 21PPM
CO2 9.0%
LOSS 13.4%
XAIR 31.4%
▶ ZERO PRS◀
```

```
PRINTING
==
09:42 ■ ?■
```

## ROOM CO TEST

No probes or hose connections are required for this test.

Rotate selector dial to Room CO

Press Enter Button to select GENERAL test type

CO readings will be logged every minute for 30 minutes.

Readings will be saved once the 30 minute test is completed.

Test results and LOG number will be displayed.

Press Print Button to Print the test results.

This LOG will be saved in the LOGS/ROOM CO MENU screen.

```
ROOM CO
MEM. 1/25
▶ RUN ◀
```

```
TEST TYPE
▶ GENERAL ◀
```

```
ROOM CO
▶ START ◀
```

```
ROOM CO
MEM. 1/25
▶ RUN ◀
```

## PRINTING

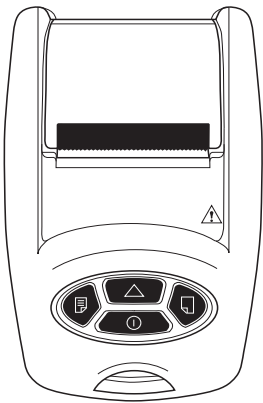

[IRP2]

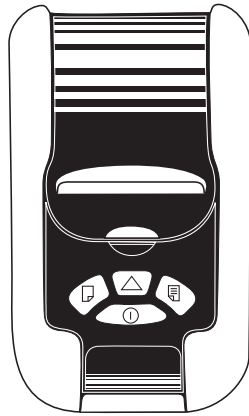

[KMIRP2]

Rotate selector Dial to **Menu** Position.

Use **▲** or **▼** **Arrow Buttons** to select Printer.

Press **←** button.

Use **▲** or **▼** **Arrow Buttons** to select Printer type (KMIRP, IRP-2/3)

### Wireless Printer App

Please see pages 15 and 16

To Go to LINK setting on Rotary Dial

Use Up or Down arrows

Select App to print

## PRINTOUTS

O2/Eff

CO/CO2

AUX

PRS/TEMP

HEAT EXCHANGE

```

UEI
C165
SN00182 2.00.rc16
NAME
NUMBER
SERIAL NO. 122621005
DATE 07/15/21
TIME 22:23:13
-----
CAL DUE 06/28/22
-----
COMBUSTION
FUEL NAT GAS
O2 REF % 3.0
CO2 % 0.00
O2 % 21.0
CO PPM 0
CO/CO2 PPM 0.0000
T1 °F ---
T2 °F ---
T3 °F 78.1
NETT °F ---
EFF9C % ---
LOSS % ---
XAIR % 02++
PRS inH2O -0.000
-----
CUSTOMER
:
:
:
-----
APPLIANCE
:
:
:
-----
REFERENCE
:
:
:
    
```

```

UEI
C165
SN00182 2.00.rc16
NAME
NUMBER
SERIAL NO. 122621005
DATE 07/15/21
TIME 22:24:48
-----
CAL DUE 06/28/22
-----
COMBUSTION
FUEL NAT GAS
O2 REF % 3.0
CO2 % 0.00
O2 % 21.0
CO PPM 0
CO/CO2 PPM 0.0000
T1 °F ---
T2 °F ---
T3 °F 78.9
NETT °F ---
EFF9C % ---
LOSS % ---
XAIR % 02++
PRS inH2O 0.000
-----
CUSTOMER
:
:
:
-----
APPLIANCE
:
:
:
-----
REFERENCE
:
:
:
    
```

```

UEI
C165
SN00182 2.00.rc16
NAME
NUMBER
SERIAL NO. 122621005
DATE 07/15/21
TIME 22:22:42
-----
CAL DUE 06/28/22
-----
AUXILIARY
FUEL NAT GAS
O2 % 21.0
CO PPM 0
PRS inH2O 0.000
Ta °F 77.8
NETT °F ---
-----
CUSTOMER
:
:
:
-----
APPLIANCE
:
:
:
-----
REFERENCE
:
:
:
    
```

```

UEI
C165
SN00182 2.00.rc16
NAME
NUMBER
SERIAL NO. 122621005
DATE 07/15/21
TIME 22:25:42
-----
CAL DUE 06/28/22
-----
PRS/TMP
T1 °F ---
T2 °F ---
NETT °F ---
PRS inH2O 0.000
-----
CUSTOMER
:
:
:
-----
APPLIANCE
:
:
:
-----
REFERENCE
:
:
:
    
```

```

UEI
C165
SN00182 2.00.rc16
NAME
NUMBER
SERIAL NO. 122621005
LOG DATE 07/15/21
DATE 22:26:37
TIME
-----
CAL DUE 06/28/22
-----
EXCHANGE TEST
FUEL NAT GAS
BLOWER OFF % 21.0
CO PPM 0
XAIR % 02++
BLOWER ON
O2 % 21.0
CO PPM 0
XAIR % 02++
DURATION SEC 60
DELTA
O2 % 0.0
CO PPM 0
XAIR % 02++
-----
CUSTOMER
:
:
:
-----
APPLIANCE
:
:
:
-----
REFERENCE
:
:
:
    
```

PRINTOUTS (CONT.)

WPC2

DTHA2

-----  
UEI  
C165  
SN00182 2.00,rc16  
NAME  
NUMBER  
SERIAL NO. 122621005  
DATE 07/15/21  
TIME 10:57:54  
-----  
CAL DUE 06/28/22  
-----  
PRS/TMP  
WT1 \*F 81.1  
WT2 \*F 81.5  
NETT \*F -0.4  
PRS inh20 0.000  
-----  
CUSTOMER  
.....  
.  
.  
.  
-----  
APPLIANCE  
.....  
.  
.  
.  
-----  
REFERENCE  
.....  
.  
.  
-----

-----  
UEI  
C165  
SN00182 2.00,rc16  
NAME  
NUMBER  
SERIAL NO. 122621005  
DATE 07/15/21  
TIME 11:03:20  
-----  
CAL DUE 06/28/22  
-----  
AUXILIARY  
-----  
DTHA2  
V n/s 0.0  
T \*F 77.4  
RH % 50.2  
-----  
CUSTOMER  
.....  
.  
.  
.  
-----  
APPLIANCE  
.....  
.  
.  
.  
-----  
REFERENCE  
.....  
.  
.  
-----



Install the App

- Free download from Apple® App store
- Search for “Kane Wireless Printer” and install

Upon opening App the first time, it will ask you a series of questions:

- Allow access to device location (GPS)
- Allow access to contacts (for emailing)

**Kane Wireless Printer App Home iOS Screen**

Pairing the Kane Wireless Printer app with your Analyzer

Turn on your analyzer allowing a complete startup

In the App Press **PRINTOUT**

Select **CONNECT TO ANALYZER**

- Your Analyzer’s serial number, preceded by a “K”, should appear
- Select your analyzer to pair

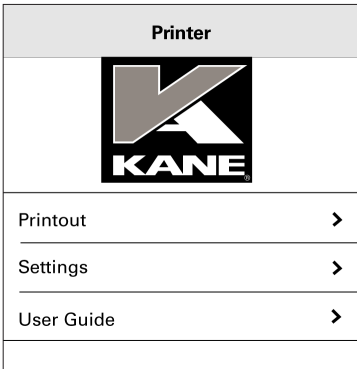

**Kane Wireless Printer App Settings Screen**

Print to App from Analyzer

- When testing in the AUX, O2/Eff, CO/CO2, PRS/TEMP, HEAT EXCH screen
- Press **FILE (Wireless) Button** to enter print menu
- Scroll **ARROW Button** to select Wireless
- Press **Button** to print to App

To Disconnect an analyzer

- Select disconnect from Printout screen

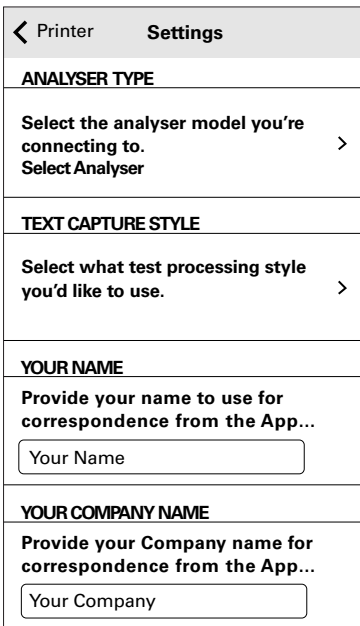

Adding Notes & Emailing from the Kane Wireless Printer App

In PRINTOUT screen, Select EMAIL PRINTOUT

- A message window will open
- Enter email address
- Add message/notes to Printout
- Send message

Select CLEAR CONSOLE to delete a Printout

- Press to Confirm deletion

To print Saved LOGS from Analyzer to App

To print Saved LOGS from Analyzer to App

- Rotate Selector dial to MENU
- Press **▲ or ▼ Arrow Buttons** to select LOGS. Press **Button**
- In the LOGS screen. Press **Button** to VIEW.
- Press **▲ or ▼ Arrow Buttons** to select LOGS VIEW you want. Press **Button**

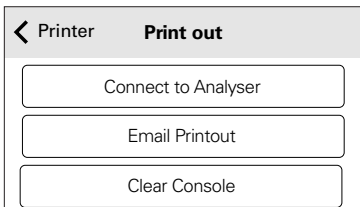

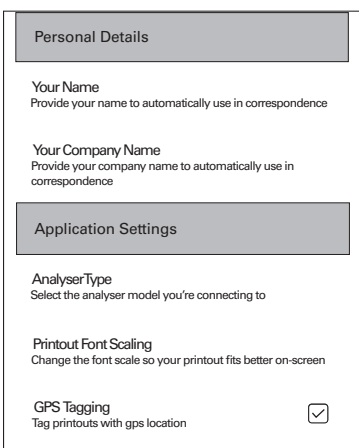
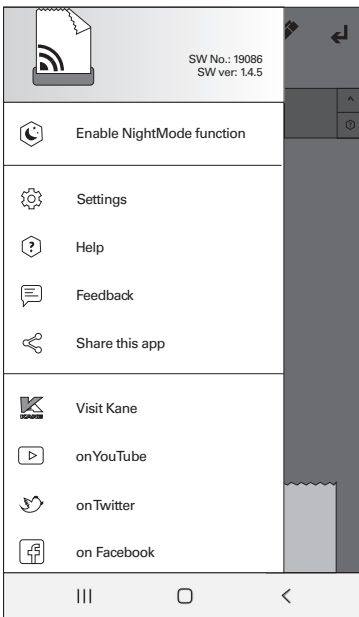
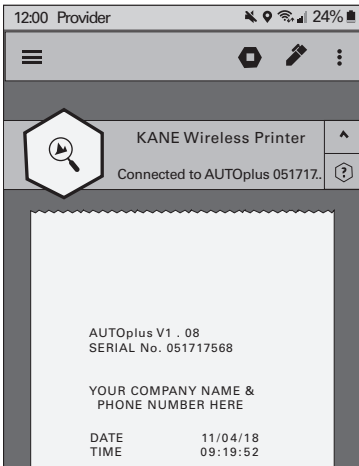

Installing the App

- Free download from Google Play
- Search for “Kane Wireless Printer” and install

Upon opening App the first time, it will ask you a series of questions:

- Allow access to device location (GPS)
- Allow access to contacts (for emailing)

**Kane Wireless Printer App Home Android Screen**

Start up

- Press the **Menu icon** in top left of screen
- Press Settings
  - A. Select “Your Name”, enter name and Press “OK”
  - B. Select “Your Company Name”, enter name and Press “OK”
  - C. Select “Analyser Type” select “Other Kane Analyser”

**Kane Wireless Printer App Android Settings Screen**

Pairing the Kane Wireless Printer app with your Analyzer

- Turn on your analyzer and allow it to complete its startup
- Touch the Kane Wireless Printer banner of the home page
- From the “Pick a device” screen, touch “Scan For Devices” at the bottom of the page
- Your Analyzer’s serial number, proceeded by a “K”, appears of the list. Select it to pair

Print to App from Analyzer

- When testing in AUX, O2/Eff, CO/CO2, PRS/TEMP, HEAT EXCH screen
- Press **FILE (Wireless) Button** to enter print menu
- Scroll **Arrow Button** to select Wireless
- Press **Button** to print to App

To Disconnect an analyzer

- Select disconnect from Printout screen

Adding Notes & Emailing from the Kane Wireless Printer App

- After a report is on the app, Press the **Pen icon** on the top right of the app screen.
- Press “Write your note here” and you can type your notes for the report. Press “OK” **icon** when done and it will save the note under the report.
- Press the **“3 vertical dots” icon** on the right side of the screen
- From that drop-down menu, Press **“Email” icon**
- Find and select your email app from the list. The email app will open to a new message and your report will be attached

**Kane Wireless Printer App Android Personal Details Screen**

To print Saved LOGS from Analyzer to App

- Rotate Selector dial to MENU
- Press or **Arrow Buttons** to select LOGS. Press **Button**
- In the LOGS screen. Press **Button** to VIEW.
- Press or **Arrow Buttons** to select LOGS VIEW you want. Press **Button**



## PRESSURE/TEMPERATURE TESTING

Select the Temperature Rotary Dial position.

Use the T1 connection for the Flue Probe temperature sensor

Use the T2 connection for the Inlet temperature sensor

Use the P1 connection for pressure

Use the P2 connection for differential pressure

Real time temperature difference

Real time pressure reading



### **WARNING**

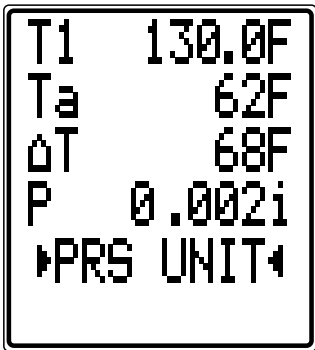

NEVER ATTEMPT TO TAKE A PRESSURE READING WITHOUT KNOWING THE MAXIMUM PRESSURE THAT MIGHT BE PRESENT. THIS INSTRUMENT'S PRESSURE TRANSDUCER IS **RATED AT 1.1 PSI WITH A MAXIMUM OVER RANGE OF 5.8 PSI**.



Select "TEMP/PRS". The pump stops automatically. Using the black connectors and manometer hose.

Pressure units can be selected via "MENU".

Press   to print a full pressure test, (or send to Smart Device via optional Wireless module).

Hold   for 2+ seconds to log a pressure report.

## PRESSURE MEASUREMENT GOOD PRACTICE

### **WARNING**

*Before using the UEi C165+ to measure the pressure of a gas/air ratio valve, read the manufacturer's manual thoroughly. If in doubt, contact the manufacturer.*

**After adjusting a gas/air ratio valve, it is essential the CO, CO<sub>2</sub> are within the manufacturer's specified limits.**

## LARGE BORE TUBING ISSUES

If using larger bore tubing when performing pressure tests:

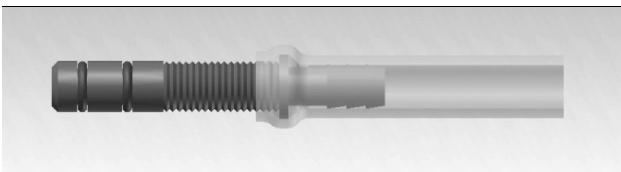

 Push tubing over the rim of the spigot to ensure a gas tight seal.

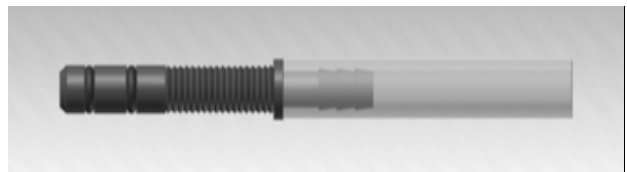

 This may not produce a gas tight seal.

Connecting WPC2 or DTHA2 to FGA  
 Select Menu option with Rotary Dial in LINK position  
 Options are APP or LINK  
 In LINK option  
 Press ENTER button to select choice  
 ADD, REMOVE, STATUS, BACK use Up or Down arrow button to select option  
 Select a device (WPC2, DTHA2) use Up or Down arrow button to select device  
 Enter WPC2 or DTHA2 serial number

Serial Number if more than 10 digits, use only last 10 digits  
 Serial Number if less than 10 digits add 000 (i.e., 0002001228)  
 All WPC2 serial number start with 01AF2

NOTE: WPC2 will require adding serial number for each clamp

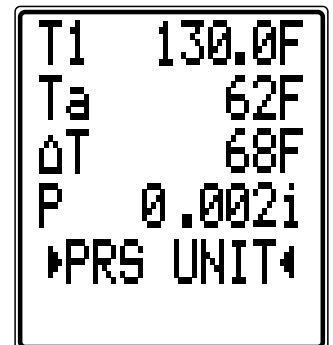

## ANALYZER SPECIFICATIONS

PARAMETER	RANGE	RESOLUTION	ACCURACY
<b>Temp Measurement</b>			
Flue Temperature	32°-1112°F	0.1°F	±3.6°F ±0.3% reading
Inlet Temperature (Internal sensor)	32°-122°F	0.1°F	±3.6°F ±0.3% reading
Inlet Temperature (External sensor)	32°-1112°F	0.1°F	±3.6°F ±0.3% reading
<b>Flue Gas Measurement</b>			
Oxygen* <sup>2</sup>	0-21%	0.1%	±0.3%
Carbon monoxide* <sup>1</sup>	0 to 2000ppm 2000 to 9999ppm Above 9999ppm Purge pump operates	1ppm	±3ppm or ±5% of rdg ±10% of rdg unspecified
Carbon dioxide* <sup>1</sup>	0-20%	0.1%	±0.3% volume
Efficiency (Net or Gross)* <sup>2</sup>	0-99.9%	0.1%	±1.0% reading
Efficiency High (C)* <sup>2</sup>	0-119.9%	0.1%	±1.0% reading
Excess Air* <sup>2</sup>	0-250%	0.1%	±0.2% reading
CO/CO <sub>2</sub> ratio* <sup>2</sup>	0-0.999	0.0001	±5% reading
<b>Nitric Oxide Sensor</b> (optional)	0 to 100ppm  Overrange to 1500ppm	1ppm	+ 2ppm <30ppm* <sup>1</sup> +5ppm <100ppm* <sup>1</sup>  +5% reading >100ppm
<b>Pressure (differential)</b>	±80mbar	0.1mbar	±0.5% FSD
<b>Pre-programmed Fuels</b>	NAT GAS, H OIL, PELLLETS,OIL, LPG, BUTANE, PROPANE		
<b>User programmed Fuels</b>	5 user defined fuels		
<b>Storage Capacity</b>	45 Total Tests		

\*1 Using dry gases at STP

\*2 Calculated

## ANALYZER SPECIFICATIONS CONT.

**Carbon Dioxide resolution is 0.01% below 1% measured value.**

<b>Ambient Operating Range</b>	32° to 113°F (0° to 45°C) 10% to 90% RH
<b>Storage Temperature Range</b>	0° to 120°F (-18° to 50°C)
<b>Battery Type / Life</b>	3 AA cells >8 hours using Alkaline AA cells
<b>Chargers (optional)</b>	100-240v charger, for NiMH batteries only
<b>Dimensions</b> Probe:	7.87 x 1.77 x 3.5 in (200 x 45 x 90mm) 11.8 in (300mm) long including handle. 2.3 dia. x 9.4 in (6mm dia. x 240mm) long stainless-steel shaft with 6.5ft (2m) long neoprene hose. Type K thermocouple
<b>CO Protection Pump:</b>	Operates at 20,000ppm measured CO.

The C165+ is in conformity with the relevant Union harmonization legislation listed below:

Directive	Title
201430EU	Electromagnetic Capability
201165EU	Restriction of use of certain hazardous substances in electrical and electronic equipment (RoHS)

The following harmonized standards and technical specifications have been applied:

### CERTIFICATION

The UEi C165+ is TUV-tested and certified to EN 50379, Parts 1, 2 & 3 in accordance to 1st German Federal Emission Control Ordinance (BlmSchV)

**EMC**

EN507270:2015

**Safety**

EN61010-1:2010

**RoHS**

IEC62321-2:2013, IEC62321-1:2013; IEC62321-3-1:2013, IEC63321-5:2013, IEC623321-4:2013, IEC62321-7-2:2017, IEC62321-7-1:2015, IEC62321-6:2015, AHRI 1260

**FCC**

### ELECTROMAGNETIC COMPATIBILITY

European Council Directive 89/336/EEC requires electronic equipment not to generate electromagnetic disturbances exceeding defined levels and have adequate immunity levels for normal operation. Specific standards applicable to this analyzer are stated below.

As there are electrical products in use pre-dating this Directive, they may emit excess electromagnetic radiation levels and, occasionally, it may be appropriate to check the analyzer before use by:

- Use the normal start up sequence in the location where the analyzer will be used.
- Switch on all localized electrical equipment capable of causing interference.
- Check all readings are as expected. A level of disturbance is acceptable.
- If not acceptable, adjust the analyzer's position to minimize interference or switch off, if possible, the offending equipment during your test.

At the time of writing this manual (November 2020) UEi Test Instruments is not aware of any field-based situation where such interference has occurred, and this advice is only given to satisfy the requirements of the Directive. This product has been tested for compliance with the following generic standards and is certified to be compliant.

EN 61000-6-3 : 2011  
EN 61000-6-1 : 2007

Specification EC/EMC/KI/C165+ details the specific test configuration, performance and conditions of use.

## Air Conditioning / Heat Pump

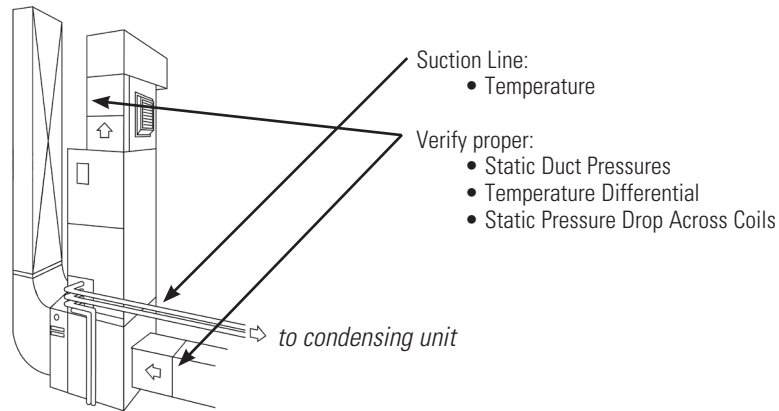

## Boiler & Water Heaters & High Efficiency Modulating Hot Water Systems

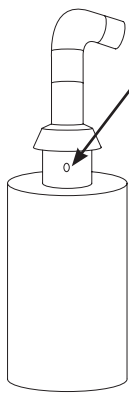

- Boiler**
- Verify proper combustion:
- O<sub>2</sub>
  - CO<sub>2</sub>
  - CO Air Free
  - Stack Temp
  - Stack Draft

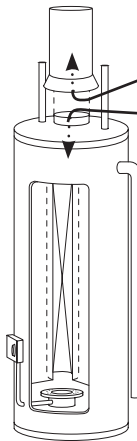

- Water Heater**
- Draft
- Verify proper combustion:
- O<sub>2</sub>
  - CO<sub>2</sub>
  - CO
  - Stack Temp
  - Efficiency

### HE Boiler Instant Water Heaters

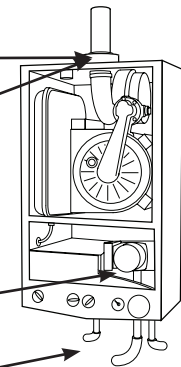

- Draft
- Verify proper combustion:
- O<sub>2</sub>
  - CO<sub>2</sub>
  - CO
  - Stack Temp
  - Efficiency
- Hi / Low fire Gas Pressure
- Supply and Return Water temp

## Furnaces: 80%

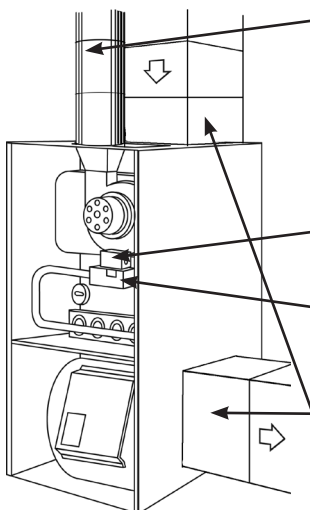

- 80% Furnace**
- Verify proper combustion:
- O<sub>2</sub>
  - CO<sub>2</sub>
  - CO
  - Stack Temp
  - Vent Pressure
  - Efficiency
- Verify/Set Up
- Gas Pressure
- Test
- Limit Switch
  - Pressure Switch
- Verify proper operation:
- Static Duct Pressure
  - Temperature Rise
  - AC side Static Pressure Drop across coils

## Furnaces: 90%

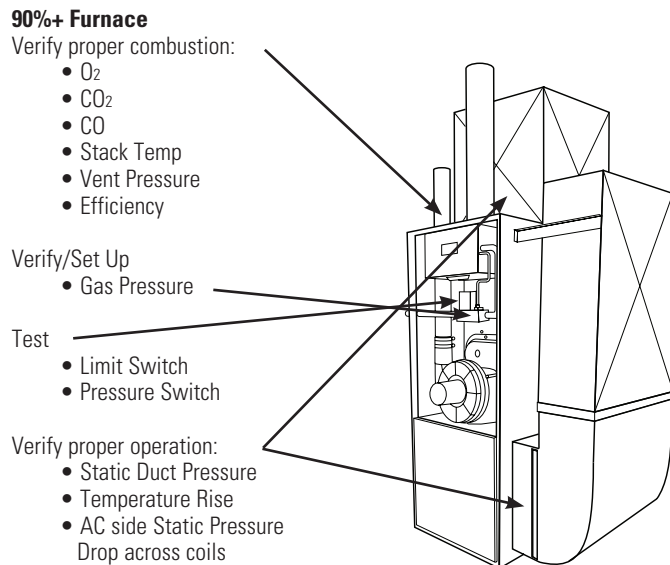

- 90%+ Furnace**
- Verify proper combustion:
- O<sub>2</sub>
  - CO<sub>2</sub>
  - CO
  - Stack Temp
  - Vent Pressure
  - Efficiency
- Verify/Set Up
- Gas Pressure
- Test
- Limit Switch
  - Pressure Switch
- Verify proper operation:
- Static Duct Pressure
  - Temperature Rise
  - AC side Static Pressure Drop across coils

**Furnaces (continued): Atmospheric, Gas & Oil**

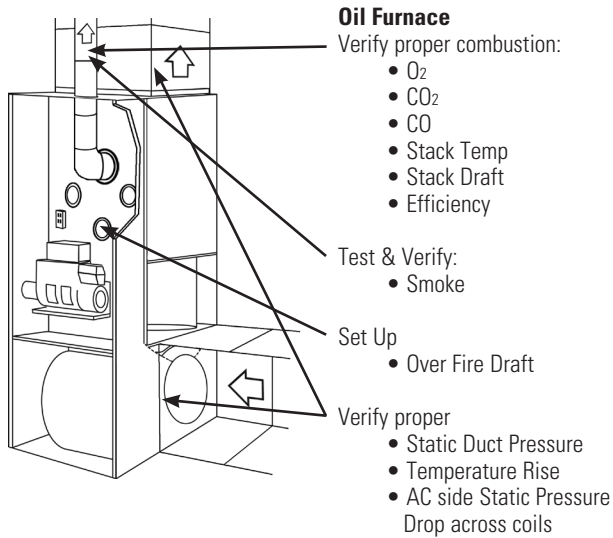
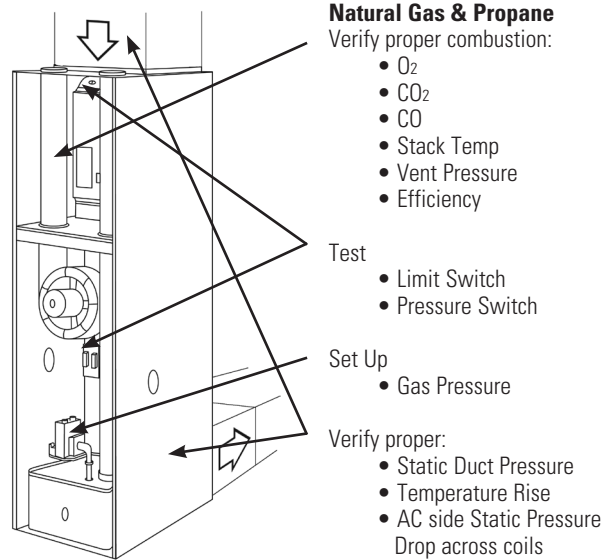
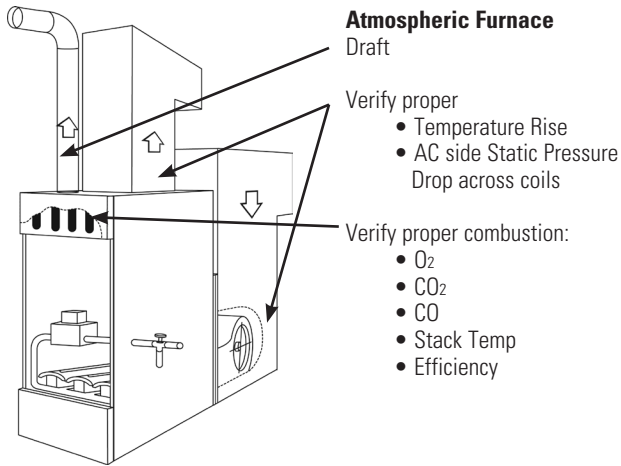

**WHAT RESULTS ARE GENERALLY ACCEPTABLE**

	<b>Atmospheric Gas Fixed Burners</b>	<b>Gas Fired Burners</b>	<b>Oil Fired burners (#2 Oil Fuel)</b>	<b>Positive Overfire Gas &amp; Oil</b>
Oxygen	7 to 9% O <sub>2</sub>	3 to 6% O <sub>2</sub>	4 to 7% O <sub>2</sub>	3 to 9% O <sub>2</sub>
Stack temperature	325° to 500°F	275° to 500°F	325° to 600°F	
Draft (Water Column Inches)	-.02 to -.4 InWC	-.02 to -.4 InWC	-.04 to -.6 InWC	-.02 to -.4 InWC
Carbon Monoxide (parts per million)	<100 ppm	<100 ppm	<100 ppm	<100 ppm
Overfire Draft (Water Column Inches)		-.02 InWC	-.2 InWC	0.4 to 0.6 InWC
Smoke			0 (manufacturer's recommendation)	

**NOTE:** Follow manufacturer guidelines for the specific equipment being serviced

**Typical Excess Air Levels**

	O <sub>2</sub> % (measured)	Excess Air %
Natural Gas	3%	16.7%
LIGHT Oil	5%	31%
Coal	8%	62%

## POWERING OFF

When you power off the C165+, there is a 45 second purge when in O2/Eff, CO, CO2, AUX screens.

Make sure you do not exceed the analyzer's operating specifications. In particular:

- Do not exceed the flue probes maximum temperature (1112°F)
- Do not exceed the analyzer's internal temperature range
- Do not put the analyzer on a hot surface
- Do not exceed the water trap's level
- Do not let the particle filter become dirty and blocked

View the displayed data to ensure that the stable operating conditions have been achieved and the readings are within the expected range.

## POST TEST

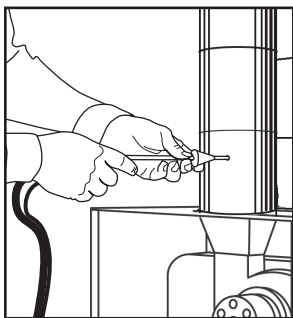

O2	5.00%
EFnc	88%
T1	154F
Ta	62F
P	3.150i
▶NAT GAS 1	

Remove the probe from the flue and allow analyzer to purge with fresh air until readings return to zero. O2 to 20.9%, CO to Zero (Be careful the probe tip will be HOT).

## GENERAL MAINTENANCE

- Re-certify your instrument annually to ensure it meets original performance specification
- Keep your instrument dry, if it gets wet, wipe dry immediately. Liquids can degrade electronic circuits
- Whenever practical, keep the instrument away dust and dirt that cause premature wear
- Although your instrument is built to withstand the rigors of daily use, it can be damaged by severe impacts.
- Use reasonable caution when using and storing this meter

## PERIODIC SERVICE



### WARNING

Repair and service of this instrument is to be performed by qualified personnel only. Improper repair or service could result in physical degradation of the instrument. This could alter the protection from personal injury this meter provides to the operator. Perform only those maintenance tasks that you are qualified to do.

## COLD WEATHER PRECAUTIONS

It is important you keep your flue gas analyzer in a warm and dry place overnight

Electronic devices that become really cold, by being left in a vehicle overnight, suffer when taken into a warm room the next morning. Condensation may form which can affect the analyzer's performance & cause permanent damage. See operating and storage temperature specifications.

Electrochemical sensors used in flue gas analyzers can be affected by condensation or water being sucked into the analyzer, as the small apertures on top of sensors can become blocked with water, stopping sensors seeing flue gas. When this happens, oxygen or carbon dioxide reading will display as "—" & sensors may be permanently damaged

If you think that your analyzer is affected by condensation or water ingress, it may be possible to rectify the problem yourself. Simply leave the analyzer running in a warm place, with the pump 'ON' sampling fresh air for a few hours (use mains adapter/battery charger if needed). If, after doing this, you still experience problems please contact our Service Center.

## REPLACING THE BATTERIES

This meter has been designed for use with both Alkaline or rechargeable Nickel Metal Hydride (NiMH) batteries. No other types are recommended and will void warranty. The analyzer is supplied with 3 (AA) size NiMH rechargeable batteries. These should be installed into the instrument.

### CAUTION

Take great care when installing the batteries to observe correct polarity. Always check the meter for operation immediately after installing new batteries.

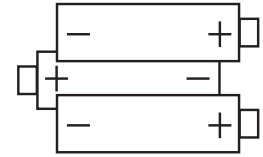

### Using Rechargeable Batteries

The battery charger must only be used when NiMH batteries are fitted. Alkaline batteries are not rechargeable. Attempting to recharge alkaline batteries may result in damage to the product and create a fire risk.

When changing the batteries, the time and date will need setting.

### WARNING

Do not try and charge the unit with Alkaline batteries fitted. Do not mix NiMH cells of different capacities from different manufacturers, all cells must be identical.

Turn over the analyzer, remove the protective rubber boot and fit 3 “AA” batteries in the battery compartment. **Take great care to ensure they are fitted with the correct battery polarity.** Replace the battery cover and the protective rubber boot.

### Time and Date

When changing the batteries, the time and date will need setting.

### Battery Disposal

Always dispose of depleted batteries using approved disposal methods that protect the environment.

### Battery Charging

Ensure that you use the correct charger. This unit uses a 5V regulated charger. Ensure the batteries are fitted in the correct manner, and charge for at least 16 hours. Subsequent charges should be overnight. NiMH batteries may be charged at any time, even for short periods to conduct testing.

### WARNING

Under NO circumstances should you expose batteries to extreme heat or fire as they may explode and cause injury. Always dispose of old batteries promptly in a manner consistent with local disposal regulations.

## CANADIAN ANNUAL RECERTIFICATION SERVICES

### KANE CANADA MEASUREMENT SOLUTIONS

All Canadian customers needing annual recertification services should...



**Complete Care for Your Combustion Analyzer.**

BACKED BY



When you:

***Request Recertification or Service Online  
Within 1 Year of Purchase or Last Service***

UEi will:

**10 Year Warranty:** All UEi combustion analyzers have a standard 1-year warranty. Each recertification extends the warranty for 1 more year for up to **10 years** from the date of purchase.

*Contractors who book recertification of a C160 series analyzer at [www.ueitest.com/service](http://www.ueitest.com/service) within 12 months from either the date of purchase or the date of the last recertification will receive reduced service pricing<sup>1</sup> that lowers the cost of ownership and 2 additional benefits:*

**Same Day Service:** All qualifying analyzers received for recertification through UEi Service+ are returned on the same business day, **GUARANTEED.**<sup>2</sup>

**Free Shipping:** UEi Service+ offers free shipping both to and from our service center. When customers book their recertification, they receive a prepaid UPS Ground shipping label.



<sup>1</sup>Pricing subject to change without notice.

<sup>2</sup>Analyzers that include the additional NO (Nitric Oxide) sensor requires 48-hour turnaround.

**PRODUCT REGISTRATION**

**Register Online**

Registering you analyzer online is quick and easy. Just log in or setup an account, it only takes a couple of minutes. Once logged in you can register you analyzer by providing some product information and uploading a proof-of-purchase.

When it's time to request recertification, just log into your account, select the analyzer, select the service and place your order.



## OTHER IMPORTANT FACTORS RELATING TO COMBUSTION

### The three T's of combustion

- **Time:** Amount of time that the fuel and oxygen are together in the combustion chamber
- **Temperature:** How high the temperature is determines the rate of oxidation, or spread of combustion
- **Turbulence:** How well the fuel and air are mixed

These three factors are all interrelated and will move your results along the combustion curves.

## COMBUSTION MEASUREMENT TERMS

Other parameters measured include Net temperature, draft and efficiency.

### Net Temperature

Net temperature is the difference between the combustion air entering the combustion chamber and the flue gas temperature past the heat exchange. This is used to determine how efficient the system is extracting heat from the combustion process in addition to the performance of the combustion process. On sealed systems that have ducted inlet air for combustion air, the Net temperature must compare this air stream temperature with the flue gases. If the appliance simply uses room air for the combustion air, our analyzers have an internal temperature sensor, so it will use this temperature when calculating Net temperature. The most accurate results for efficiency are obtained when measuring flue gases at the point where flue temperature (not flame temperature) is the highest.

### Draft

Draft is the difference between the ambient pressure level and the pressure level in the flue.

This is created either by the natural buoyancy of the hot gases created in combustion lifting, or by an inducer fan that assists the flow of flue gases up the stack. Most combustion equipment will specify the amount of draft that is required for proper operation. Draft helps draw combustion air into the combustion chamber, and also helps in mixing the fuel and oxygen. Without proper draft, the combustion process can spill poisonous by-products into the space where the appliance is located. This can be a risk to those in the area, or create a danger to residents or employees working near the combustion equipment.

### Efficiency

Efficiency is a measure of how well the fuel is burned to create heat, and how well the generated heat is captured for the intended use. The information used to create this value are based on the fuels heating value, the heat lost up the flue and the gas components in the flue gas. The original method to determine efficiency included many manual methods and lookup charts. As an example you would measure the CO<sub>2</sub> level and the stack temperature and then reference a slide scale that would give you the relative efficiency number. UEI's electronic combustion analyzers perform the measurements on a continuous basis, and can calculate the efficiency as adjustments are being made. Combine this with a printout and you are able to provide a before and after comparison of the combustion equipment in relatively little time as part of normal servicing. **Combustion efficiency is not the same as AFUE (annual fuel usage efficiency). AFUE is not measurable with any portable flue gas analyzer.**

### Combustion Efficiency Calculations

This identifies three sources of loss associated with fuel burning:

- Losses due to flue gases:  
Dry Flue gas loss, moisture and hydrogen,  
Sensible heat of water vapor, Unburned gas
- Losses due to refuse:  
Combustible in ash, riddling and dust
- Other losses:  
Radiation, convection, conduction other unmeasured losses

Net efficiency calculations assume that the energy contained in the water vapor (formed as a product of combustion and from wet fuel) is recovered and the wet loss term is zero. Gross efficiency calculations assume that the energy contained in the water vapor is not recovered. Since the fuel air mixture is never consistent there is the possibility of unburned/partially unburned fuel passing through the flue. This is represented by the unburned carbon loss. Losses due to combustible matter in ashes, riddling, dust and grit, radiation, convection and conduction are not included.

### CO Air Free

Certain standards (ANSI Z21.1) for Carbon Monoxide are stated in terms of air-free. Air-free refers to the concentration of CO in combustion gases undiluted with flue, or other gases containing little CO. This value is computed using an equation that takes into account the O<sub>2</sub> concentration of the flue gas.

- If 5% O<sub>2</sub> is measured (O<sub>2m</sub>) in the flue then the CO gas value will be recalculated as if 0% were measured. The equation for air-free is as follows:  $CO_{af} = CO \text{ PPM} \times [(20.9) / (20.9 - O_{2m})]$
- In our example if a reading of 325 PPM were measured then the air-free value would be calculated as follows:  
 $CO_{af} = 325 \text{ PPM} \times [(20.9) / (20.9 - 5)]$   $CO_{af} = 325 \text{ PPM} \times [(20.9) / (15.9)]$   $CO_{af} = 427$

We may be given a limit on our gas range by the local authority, which stated that we must not emit more than 400-PPM Carbon Monoxide air-free. In the example we would be breaking the limit and corrective action should be taken to reduce the level of CO. Air-free values prevent false readings being submitted, e.g. allowing more air into the boiler will increase the oxygen level in the flue and dilute any toxic gas reading. Air-free referencing gives readings as if they were undiluted.

## DISPOSAL



**Caution:** This symbol indicates that equipment and its accessories shall be subject to separate collection and correct disposal.

## STORAGE

Remove the batteries when instrument is not in use for a prolonged period of time. Do not expose to high temperatures or humidity. After a period of storage in extreme conditions exceeding the limits mentioned in the General Specifications section, allow the instrument to return to normal operating conditions before using it.

## END OF LIFE DISPOSAL

The Waste Electrical or Electronic Equipment (WEEE) Directive requires countries in the EU to maximize collection and environmentally responsible processing of these items. Products are now labelled with a crossed out wheeled bin symbol to remind you that they can be recycled.

**Note:** Batteries used in this instrument should be disposed of in accordance with current legislation and local guidelines.

## WARRANTY

The C165+ are warranted to be free from defects in materials and workmanship for a period of 1 year from the date of purchase. If within the warranty period your instrument should become inoperative from such defects, the unit will be repaired or replaced at UEI's option. This warranty covers normal use and does not cover damage which occurs in shipment or failure which results from alteration, tampering, accident, misuse, abuse, neglect or improper maintenance. Batteries and consequential damage resulting from failed batteries are not covered by warranty.

Any implied warranties, including but not limited to implied warranties of merchantability and fitness for a particular purpose, are limited to the express warranty. UEI shall not be liable for loss of use of the instrument or other incidental or consequential damages, expenses, or economic loss, or for any claim or claims for such damage, expenses or economic loss. A purchase receipt or other proof of original purchase date will be required before warranty repairs will be rendered. Instruments out of warranty will be repaired (when repairable) for a service charge

For more information on warranty and service, contact:

**www.ueitest.com Email: info@ueitest.com**  
**1-800-547-5740**

This warranty gives you specific legal rights. You may also have other rights, which vary from state to state.