







Note: Phone not included.

**DATA SHEET**

# Si-CA 030

**Residential & commercial combustion analyser**  
**The latest in combustion analysis technology**

**Compact, Light and Durable Design**

-  Up to three gas sensors O<sub>2</sub>, CO, and NO (for NOx)
-  Color display screen
-  Lightweight, only 350 g (12 oz)
-  Auto pump cut-off for high CO levels
-  CO sensor measurement up to 8,000 ppm
-  Data management with automatic logging & report creation



- Predictive maintenance with estimated sensor life & calibration reminders
- Draft & differential pressure measurements
- Calculated CO<sub>2</sub>% value
- NOx capable with NO sensor

- Quick and easy pump On/Off control
- Combustion efficiency & excess air calculations
- CO safety monitoring in ambient air
- Protective rubber holster
- Extended warranties available

**Dimensions**

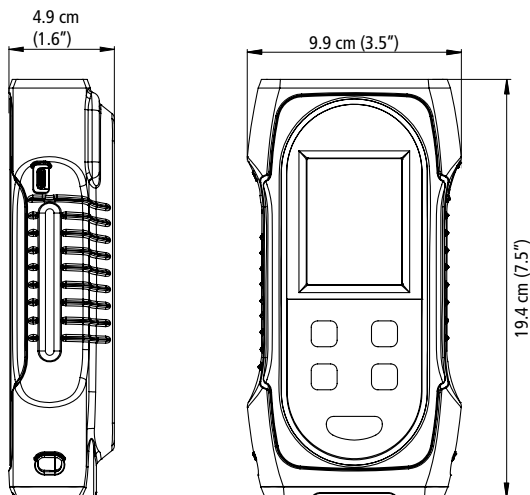

**Compact design**



## Parameter specifications

Parameter	Sensor	Measuring range	Resolution	Accuracy <sup>(1)</sup>	T <sub>90</sub> response time
O <sub>2</sub>	Electrochemical	0 to 25%	0.01%	±0.2% vol	< 30 s
CO	Electrochemical	0 to 8000 ppm	1 ppm	±8 ppm < 160 ppm ±5% rdg up to 2000 ppm ±10% rdg > 2000 ppm	< 40 s
CO <sub>2</sub>	Calculated	0 to 99.9%	0.1%	-	-
NO (optional)	Electrochemical	0 to 5000 ppm	1 ppm	±5 ppm < 100 ppm ±5% rdg > 100 ppm	< 40 s
NOx (optional)	Calculated	0 to 7500 ppm	1 ppm	-	-
Flue temperature	TcK	-20 to +1250 °C -4 to +2282 °F	0.1 °C 0.1 °F	±2 °C or ±0.5% rdg <sup>(2)</sup> ±3.6 °F or ±0.5% rdg <sup>(2)</sup>	-
Air temperature	NTC or TcK	-20 to +120 °C -4 to +248 °F	0.1 °C 0.1 °F	±2 °C ±3.6 °F	-
	Pt100	-40 to 250 °C -40 to 482 °F	0.1 °C 0.1 °F	±(0.3% rdg ±0.25) °C -40°F to 32 °F: ±(-0.3% rdg +0.6) °F 32°F to 482 °F: ±(0.3% rdg +0.4) °F	-
Differential temperature	Calculated	0 to 1250 °C 0 to 2282 °F	0.1 °C 0.1 °F	-	-
Pressure/Draft	Semiconductor	-200 to +200 mbar -80 to +80 inH <sub>2</sub> O	0.01 mbar 0.001 inH <sub>2</sub> O	±1% rdg ±0.03 mbar ±1% rdg ±0.012 inH <sub>2</sub> O	-
Excess air	Calculated	0 to 999%	1%	-	-
Efficiency	Calculated	0 to 100% (Gross/ HHV <sup>(3)</sup> )	0.1%	-	-
Efficiency (condensation)	Calculated	0 to 125% (Net/ LHV <sup>(4)</sup> )	0.1%	-	-

<sup>(1)</sup>All accuracies indicated in this document were stated in laboratory conditions at 20 °C (68 °F) and 1013 mbar and can be guaranteed for measurement carried out in the same conditions.

<sup>(2)</sup>Accuracy given for the analyzer only.

<sup>(3)</sup>For Higher Heating Value / <sup>(4)</sup>For Lower Heating Value

## General features

Dimensions	19.4 x 9.9 x 4.9 cm (7.5 x 3.5 x 4.9")
Weight	350 g (12 oz)
Display	Color display screen; Size: 320 x 240 pixels
Keypad	5 keys
Material	ABS-PC
Protection	IP42
Connection	- Wireless: class 2 range, range frequency from 2402 MHz to 2480 MHz with a transmit power of 1 dBm. Range up to 15 m (50 ft), depending on smartphone radio strength. Minimum required versions: Android 8.0, iOS 12.4, BLE 4.0 Low Energy - USB
Power supply	Rechargeable battery, USB power supply Li-Ion 5100 mA/h 3.6 V battery / Power supply voltage of the mains unit: 100-240 Vac, 50-60 Hz Mains unit: 5 Vdc/2A
Battery	Battery life > 8 h; Charging time: Fully charge: < 6.5 h; 50%: < 2.5 h
Environmental conditions of use	Temperature: from -5 to 45 °C (23 to 113 °F), Hygrometry: in non-condensing conditions (< 85% RH) Maximum altitude: 2000 m (6561')
Storage temperature	From -20 to 50 °C (-4 to 122 °F)
Languages	English, French, German, Spanish, Italian, Portuguese
European Union Directives	2014/53/EU (RED); 2015/863 EU (RoHS 3)
Regulations	EN 50379-1 and EN 50379-2; UNI 10389; UL & cUL Certification; BS 7967:2015; BS EN 50543:2011; UNE 60670-10; ES.02173.ES; TÜV SÜD Certification

## Apps

- Free apps for iOS & Android mobile devices
- Fast, easy wireless connection
- Remote live view of combustion analysis data as list or graph
- Remote control to change settings
- Data saving, including automatic logging
- Report creation in PDF, CSV (for Excel) and XML formats
- Databases for customers, operators, & equipment



Download app



Graph view

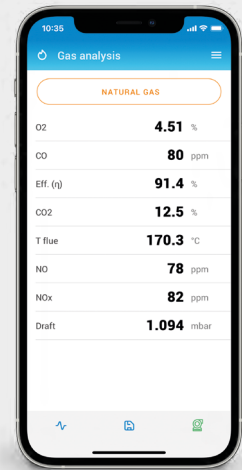

Data view

## Example of analyzer screens

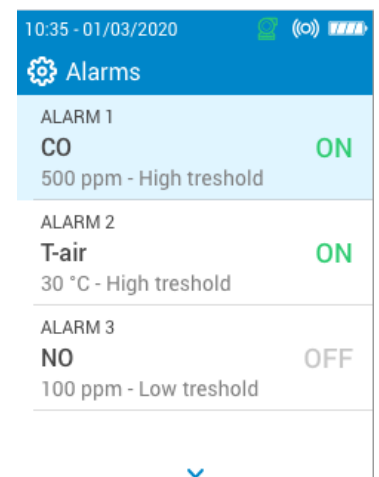
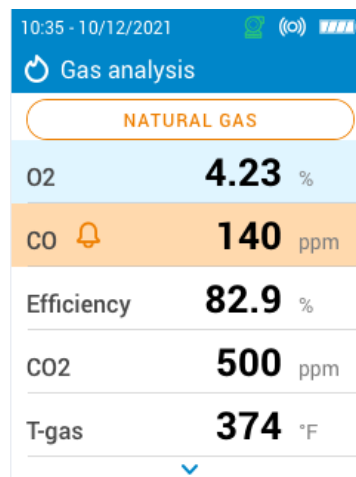
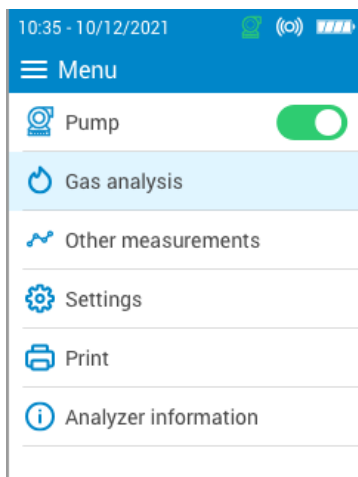

## Si-CA 030 kit content

- Si-CA 030 analyzer
- O<sub>2</sub> & CO gas sensors (NO optional)
- Protective rubber holster
- Flue gas probe with dual hose
- Water trap with filter
- AC power supply / charger
- USB cable
- Mobile app
- Internal wireless communication module
- Carrying case or box packaging
- Quick Start Guide
- Calibration certificate



## Ordering Information

Item #	Reference	Description
Si-CA 030 Kit 2AC	27495	Si-CA 030 Gas Analyzer Kit 2AC, includes two gas sensors (O <sub>2</sub> , CO), 180 mm, probe rated to 800 °C with 2 m dual hose, cardboard box packaging
Si-CA 030 Kit 2AS	27496	Si-CA 030 Gas Analyzer Kit 2AS, includes two gas sensors (O <sub>2</sub> , CO), 180 mm, probe rated to 800 °C with 2 m dual hose, vinyl carrying case
Si-CA 030 Kit 2AH	27497	Si-CA 030 Gas Analyzer Kit 2AH, includes two gas sensors (O <sub>2</sub> , CO), 180 mm, probe rated to 800 °C with 2 m dual hose, ABS hard plastic carrying case
Si-CA 030 Kit 2BS	27498	Si-CA 030 Gas Analyzer Kit 2BS, includes two gas sensors (O <sub>2</sub> , CO), 300 mm, probe rated to 800 °C with 3 m dual hose, vinyl carrying case
Si-CA 030 Kit 2BH	27499	Si-CA 030 Gas Analyzer Kit 2BH, includes two gas sensors (O <sub>2</sub> , CO), 300 mm, probe rated to 800 °C with 3 m dual hose, ABS hard plastic carrying case
Si-CA 030 Kit 3AC	27500	Si-CA 030 Gas Analyzer Kit 3AC, includes three gas sensors (O <sub>2</sub> , CO, NO), 180 mm, probe rated to 800 °C with 2 m dual hose, cardboard box packaging
Si-CA 030 Kit 3AS	27501	Si-CA 030 Gas Analyzer Kit 3AS, includes three gas sensors (O <sub>2</sub> , CO, NO), 180 mm, probe rated to 800 °C with 2 m dual hose, vinyl carrying case
Si-CA 030 Kit 3AH	27502	Si-CA 030 Gas Analyzer Kit 3AH, includes three gas sensors (O <sub>2</sub> , CO, NO), 180 mm, probe rated to 800 °C with 2 m dual hose, ABS hard plastic carrying case
Si-CA 030 Kit 3BS	27503	Si-CA 030 Gas Analyzer Kit 3BS, includes three gas sensors (O <sub>2</sub> , CO, NO), 300 mm, probe rated to 800 °C with 3 m dual hose, vinyl carrying case
Si-CA 030 Kit 3BH	27504	Si-CA 030 Gas Analyzer Kit 3BH, includes three gas sensors (O <sub>2</sub> , CO, NO), 300 mm, probe rated to 800 °C with 3 m dual hose, ABS hard plastic carrying case

## Maintenance

We carry out calibration, adjustment and maintenance of your devices to guarantee a consistent and accurate level of quality of your measurements. As part of Quality Assurance Standards, we recommend annual recalibration and maintenance check-up.

## Warranty

Devices have 2-year guarantee against any manufacturing defect (return to our After-Sales Service required for appraisal).

## Optional accessories\*

Part number	Description	Illustration
27521	NO sensor for NOx	
27532 (180 mm) 27533 (300 mm) 27534 (750 mm)	180, 300 and 750 mm probes available	
27936	180 mm flexible probe	
24646	Smart air temperature probe with 2 m cable	
27865	Pt100 temperature probe	
27547	CO ambient probe	
27548	CO <sub>2</sub> ambient probe	
27546	Remote wireless printer	
27537	3 m dual hose extension	
27538	Differential pressure hose kit	
11994	Manual smoke pump kit	
26811	SCU (Sample Conditioning Unit)	

\*See the Si-CA analyser accessories datasheet for more details.