

PROJECT: _____	UNIT TAG: _____	QUANTITY: _____
REPRESENTATIVE: _____	TYPE OF SERVICE: _____	DATE: _____
ENGINEER: _____	SUBMITTED BY: _____	DATE: _____
CONTRACTOR: _____	APPROVED BY: _____	DATE: _____
	ORDER NO.: _____	DATE: _____



MAGNA3 40-120 F

The newest high-end circulator solution, a large number of electronically controlled operation features and by far exceeding the demands from the EuP directive.

Note! Product picture may differ from actual product

Conditions of Service	Pump Data	Motor Data
Flow: _____	Maximum operating pressure: 12 bar	P1 max: 16 .. 422 W
Head: _____	Liquid temperature range: -10 .. 110 °C	Rated voltage: 208-230 V
Efficiency: _____	Maximum ambient temperature: 40 °C	Mains frequency: 60 Hz
Liquid: Water	Approvals: ETL, FCC W_RADIAL	Enclosure class: X4D
Temperature: 60 °C	Flange standard: GF	Insulation class: F
NPSH required: m	Pipe connection: GF15/26/40/43	
Viscosity: _____	Product number: On request	
Specific Gravity: 0.985		

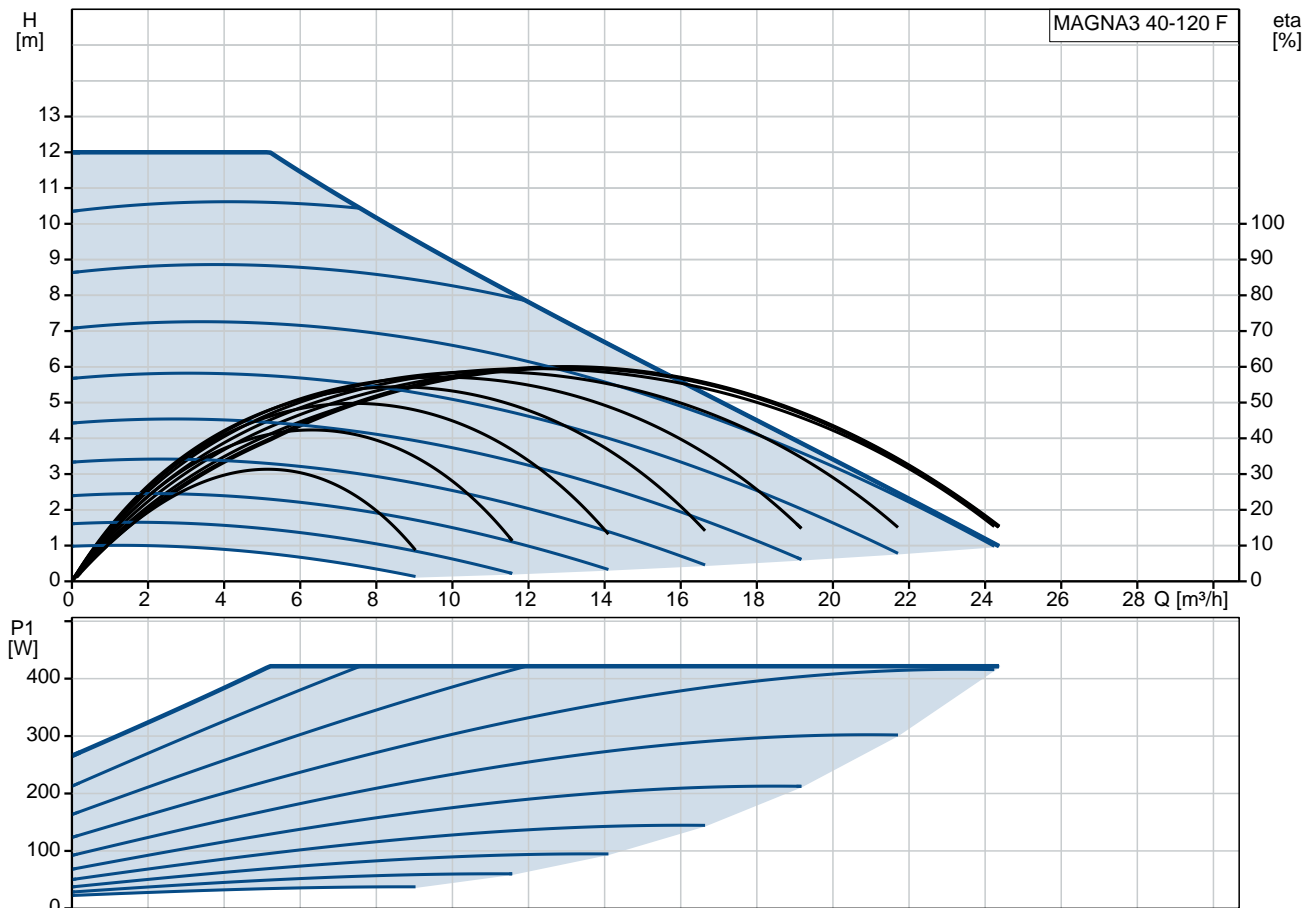

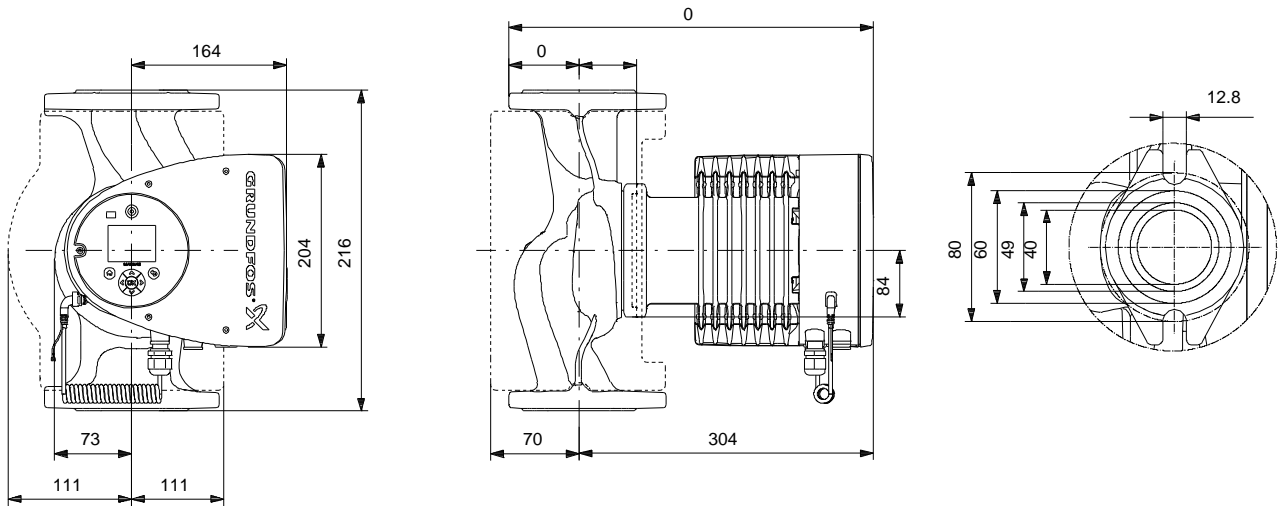

Materials:

Pump housing: Cast iron
 EN-GJL-250
 ASTM A48-250B

Impeller: PES 30%GF

Tender Text



Note! Product picture may differ from actual product

Product No.: On request

MAGNA3 40-120 F

MAGNA3 – More than a pump

With its unrivalled efficiency, all-encompassing range and built-in communication capabilities plus functionalities replacing system components, the MAGNA3 is ideal for engineers and specifiers looking to create high-performance systems for buildings.

This pump in the Grundfos Master Class will fit both heating and cooling applications perfectly, making it the obvious choice for almost any building project – old or new.

The MAGNA3 is of the canned-rotor type, i.e. pump and motor form an integral unit without shaft seal and with only two gaskets for sealing. The bearings are lubricated by the pumped liquid.

The innovative clamp with only one screw enables easy repositioning of the pump head.

The MAGNA3 is a pump with no maintenance requirements and with extremely low Life Cycle Cost.

The pump is characterised by the following:

- controller integrated in the control box
- control panel with TFT display on the control box
- control box prepared for optional CIM modules
- built-in differential-pressure and temperature sensor
- cast-iron pump housing (depending on model)
- carbon-fibre-reinforced composite rotor can
- stainless-steel bearing plate and rotor cladding
- aluminium alloy stator housing
- air-cooled power electronics

The MAGNA3 is a single-phase pump.

Characteristic features

- AUTOADAPT.
- FLOWADAPT and FLOWLIMIT (more than a pump function as it reduces the need for pump throttling valves).
- Proportional-pressure control.
- Constant-pressure control.
- Constant-temperature control.
- Constant-curve duty.
- Max. or min. curve duty.
- Automatic Night Setback.
- No external motor protection required.
- Insulating shells supplied with single-head pumps for heating systems.
- Large temperature range where the liquid temperature and the ambient temperature are independent of each other.

Communication

The MAGNA3 enables communication via the following:

- wireless Grundfos GO Remote
- fieldbus communication via CIM modules
- digital inputs
- relay outputs
- analog input (more than a pump function as heat energy meter)

Motor and electronic controller

The MAGNA3 incorporates a 4-pole synchronous, permanent-magnet motor (PM motor). This motor type is characterised by higher efficiency than a conventional asynchronous squirrel-cage motor.

The pump speed is controlled by an integrated frequency converter.

A differential-pressure and temperature sensor is incorporated in the pump.

Liquid:

Pumped liquid: Water
Liquid temperature range: -10 .. 110 °C
Liquid temperature during operation: 60 °C
Density: 983.2 kg/m³

Technical:

TF class: 110
Approvals on nameplate: ETL, FCC W_RADIAL

Materials:

Pump housing: Cast iron
EN-GJL-250
ASTM A48-250B
Impeller: PES 30%GF

Installation:

Range of ambient temperature: 0 .. 40 °C
Maximum operating pressure: 12 bar
Flange standard: GF
Pipe connection: GF15/26/40/43
Pressure rating: PN12
Port-to-port length: 216 mm

Electrical data:

Power input - P1: 16 .. 422 W
Mains frequency: 60 Hz
Rated voltage: 1 x 208-230 V
Maximum current consumption: 0.19 .. 1.89 A
Enclosure class (IEC 34-5): X4D
Insulation class (IEC 85): F

Others:

Energy (EEI): 0.19
Net weight: 16.1 kg
Gross weight: 17.6 kg
Shipping volume: 0.04 m³

Position	Qty.	Description
	1	<p>MAGNA3 40-120 F</p>  <p style="text-align: center;">Note! Product picture may differ from actual product</p> <p>Product No.: On request</p> <p>MAGNA3 – More than a pump With its unrivalled efficiency, all-encompassing range and built-in communication capabilities plus functionalities replacing system components, the MAGNA3 is ideal for engineers and specifiers looking to create high-performance systems for buildings.</p> <p>This pump in the Grundfos Master Class will fit both heating and cooling applications perfectly, making it the obvious choice for almost any building project – old or new.</p> <p>The MAGNA3 is of the canned-rotor type, i.e. pump and motor form an integral unit without shaft seal and with only two gaskets for sealing. The bearings are lubricated by the pumped liquid. The innovative clamp with only one screw enables easy repositioning of the pump head. The MAGNA3 is a pump with no maintenance requirements and with extremely low Life Cycle Cost.</p> <p>The pump is characterised by the following:</p> <ul style="list-style-type: none"> • controller integrated in the control box • control panel with TFT display on the control box • control box prepared for optional CIM modules • built-in differential-pressure and temperature sensor • cast-iron pump housing (depending on model) • carbon-fibre-reinforced composite rotor can • stainless-steel bearing plate and rotor cladding • aluminium alloy stator housing • air-cooled power electronics <p>The MAGNA3 is a single-phase pump.</p> <p>Characteristic features</p> <ul style="list-style-type: none"> • AUTOADAPT. • FLOWADAPT and FLOWLIMIT (more than a pump function as it reduces the need for pump throttling valves). • Proportional-pressure control. • Constant-pressure control. • Constant-temperature control. • Constant-curve duty. • Max. or min. curve duty. • Automatic Night Setback. • No external motor protection required. • Insulating shells supplied with single-head pumps for heating systems. • Large temperature range where the liquid temperature and the ambient temperature are independent of each other. <p>Communication The MAGNA3 enables communication via the following:</p> <ul style="list-style-type: none"> • wireless Grundfos GO Remote • fieldbus communication via CIM modules • digital inputs • relay outputs • analog input (more than a pump function as heat energy meter)

Position	Qty.	Description
		<p>Motor and electronic controller The MAGNA3 incorporates a 4-pole synchronous, permanent-magnet motor (PM motor). This motor type is characterised by higher efficiency than a conventional asynchronous squirrel-cage motor. The pump speed is controlled by an integrated frequency converter. A differential-pressure and temperature sensor is incorporated in the pump.</p> <p>Liquid: Pumped liquid: Water Liquid temperature range: -10 .. 110 °C Liquid temperature during operation: 60 °C Density: 983.2 kg/m³</p> <p>Technical: TF class: 110 Approvals on nameplate: ETL, FCC W_RADIAL</p> <p>Materials: Pump housing: Cast iron EN-GJL-250 ASTM A48-250B Impeller: PES 30%GF</p> <p>Installation: Range of ambient temperature: 0 .. 40 °C Maximum operating pressure: 12 bar Flange standard: GF Pipe connection: GF15/26/40/43 Pressure rating: PN12 Port-to-port length: 216 mm</p> <p>Electrical data: Power input - P1: 16 .. 422 W Mains frequency: 60 Hz Rated voltage: 1 x 208-230 V Maximum current consumption: 0.19 .. 1.89 A Enclosure class (IEC 34-5): X4D Insulation class (IEC 85): F</p> <p>Others: Energy (EEL): 0.19 Net weight: 16.1 kg Gross weight: 17.6 kg Shipping volume: 0.04 m³</p>

On request MAGNA3 40-120 F 60 Hz

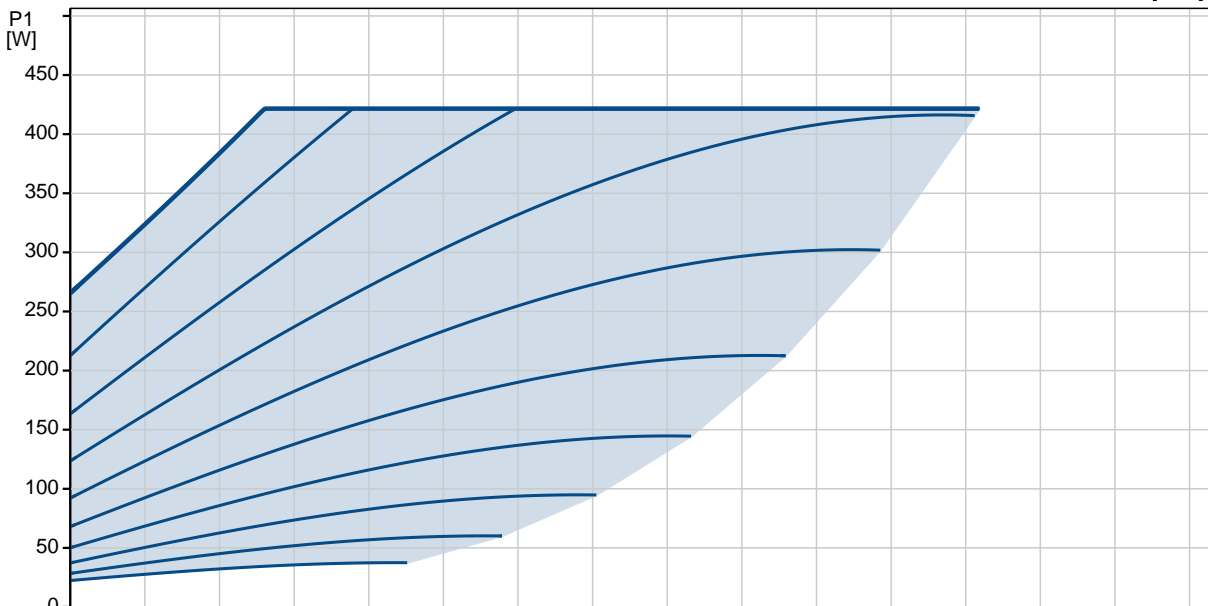
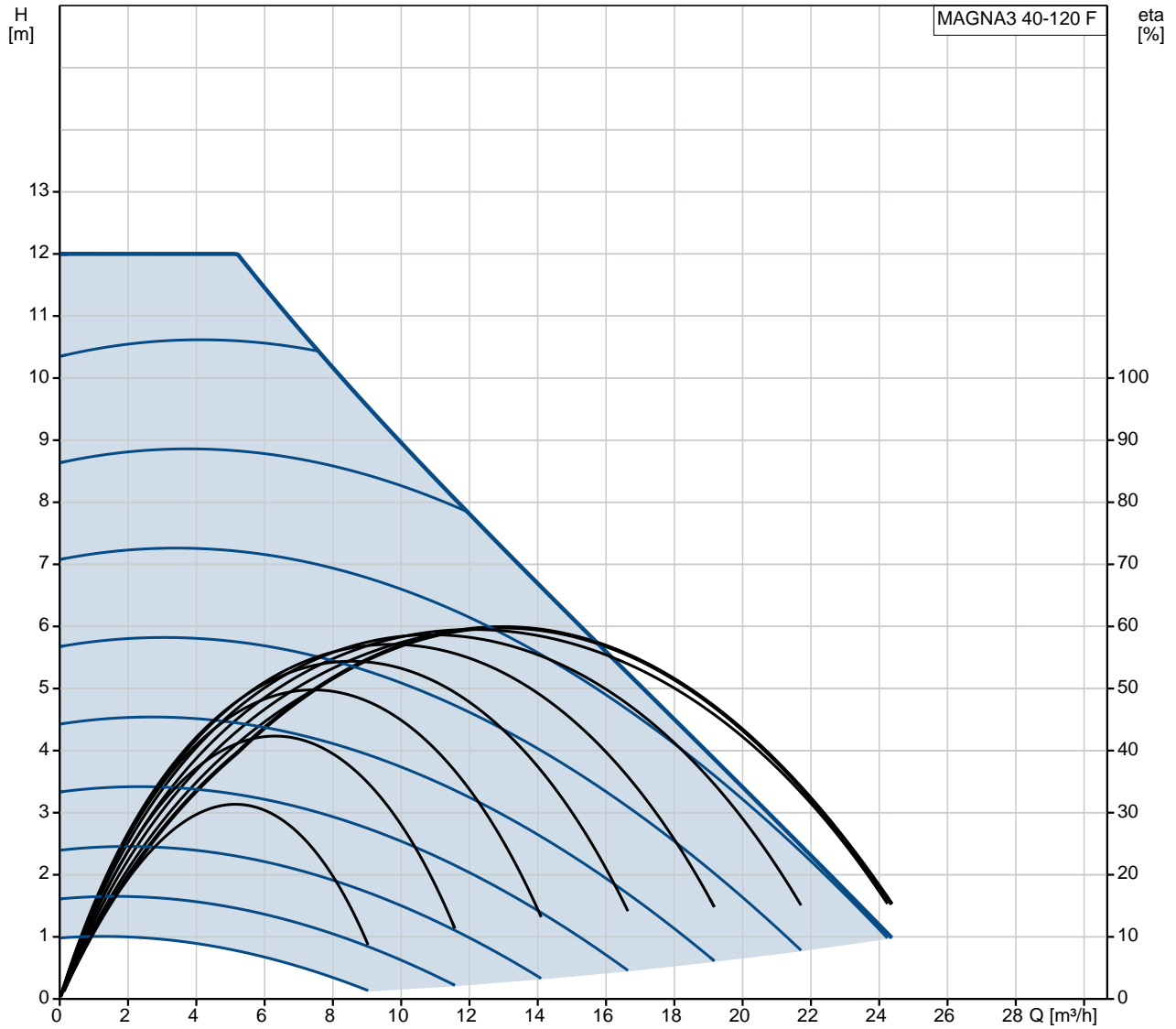

Description	Value
General information:	
Product name:	MAGNA3 40-120 F
Product No:	On request
EAN number:	On request
Technical:	
Head max:	120 dm
TF class:	110
Approvals on nameplate:	ETL, FCC W_RADIAL
Model:	A
Materials:	
Pump housing:	Cast iron EN-GJL-250 ASTM A48-250B
Impeller:	PES 30%GF
Installation:	
Range of ambient temperature:	0 .. 40 °C
Maximum operating pressure:	12 bar
Flange standard:	GF
Pipe connection:	GF15/26/40/43
Pressure rating:	PN12
Port-to-port length:	216 mm
Liquid:	
Pumped liquid:	Water
Liquid temperature range:	-10 .. 110 °C
Liquid temperature during operation:	60 °C
Density:	983.2 kg/m ³
Electrical data:	
Power input - P1:	16 .. 422 W
Mains frequency:	60 Hz
Rated voltage:	1 x 208-230 V
Maximum current consumption:	0.19 .. 1.89 A
Enclosure class (IEC 34-5):	X4D
Insulation class (IEC 85):	F
Others:	
Energy (EEI):	0.19
Net weight:	16.1 kg
Gross weight:	17.6 kg
Shipping volume:	0.04 m ³

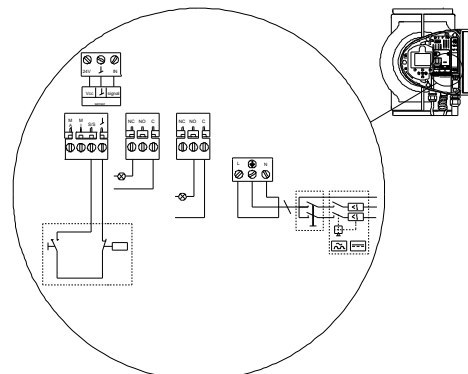
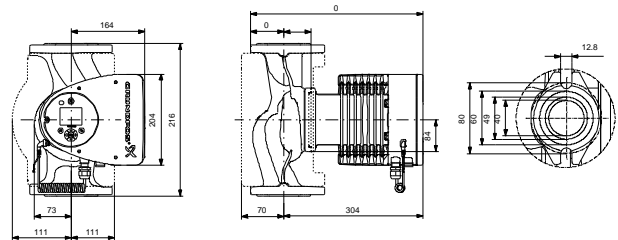
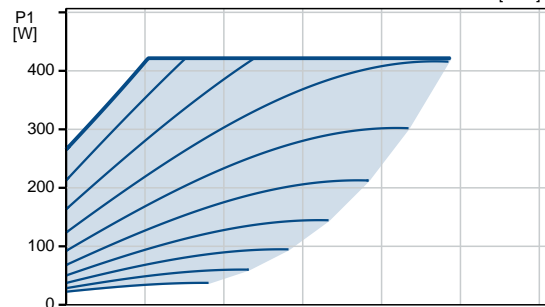
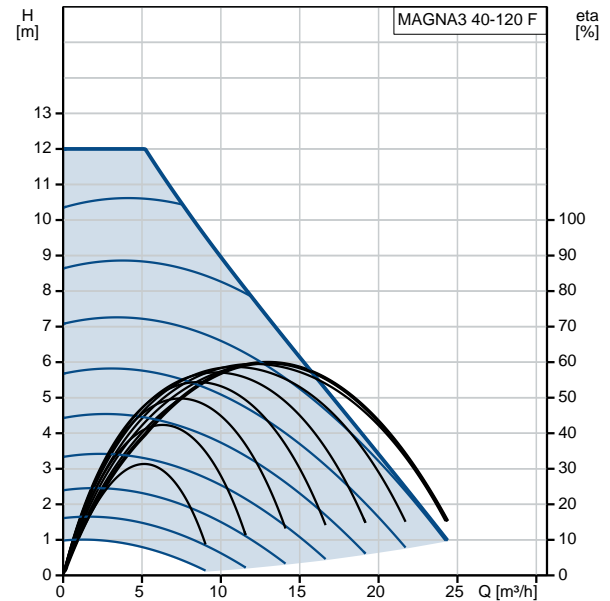

On request MAGNA3 40-120 F 60 Hz

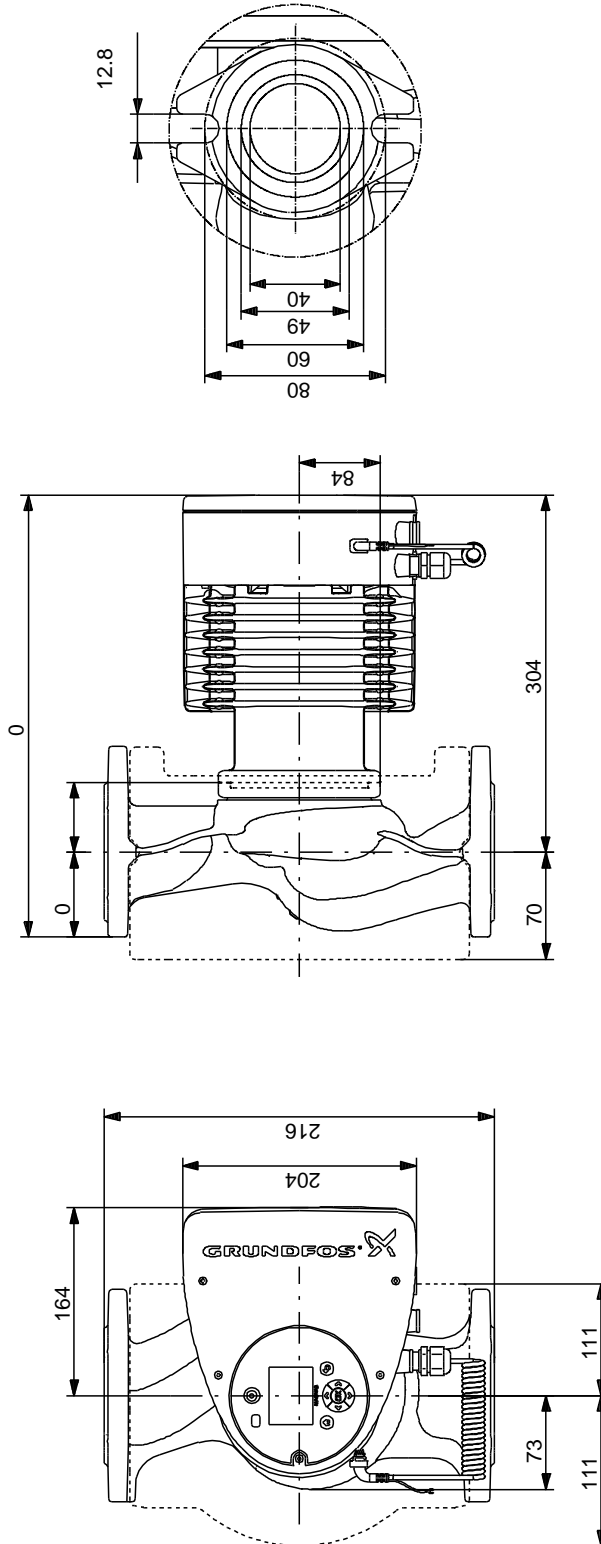

Note! All units are in [mm] unless others are stated.
Disclaimer: This simplified dimensional drawing does not show all details.

On request MAGNA3 40-120 F 60 Hz

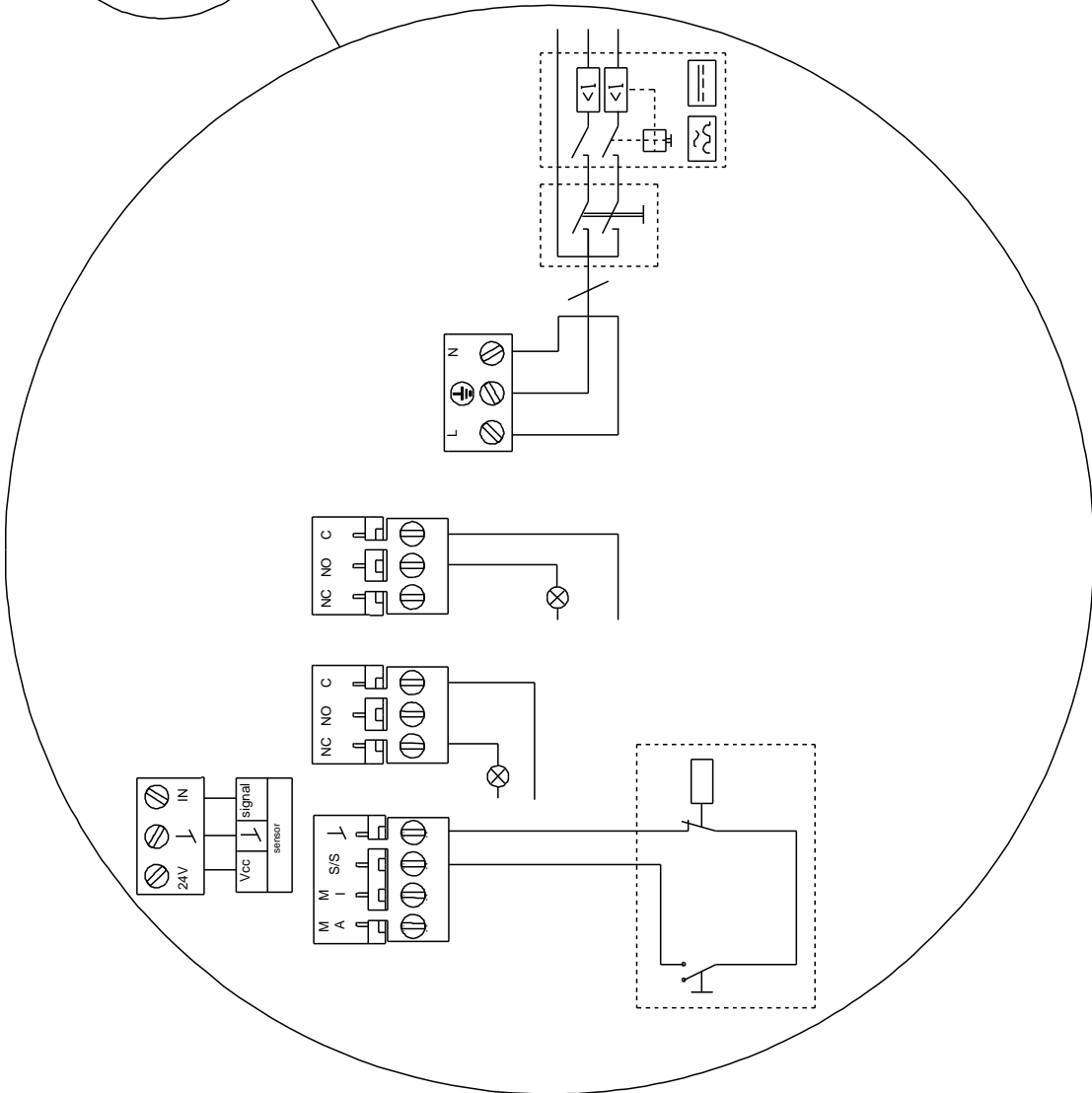
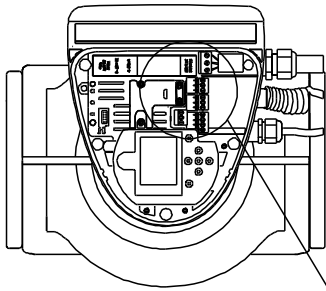

Note! All units are in [mm] unless others are stated.



Company name:

Created by:

Phone:

Date: 28/11/2017

Order Data:

Product name: MAGNA3 40-120 F

Amount: 1

Product No: On request

Total: Price on request

(TM031247 1405)

