

DLFUAA

Service Manual

Air Handler Unit Ductless System - Sizes 18 to 60

TABLE OF CONTENTS

	PAGE
SAFETY CONSIDERATIONS	1
INTRODUCTION.....	1
MODEL NUMBER NOMENCLATURE	2
AUXILLIARY CONTACTS FOUND ON THE MAIN BOARD..	3
ROTARY AND DIP SWITCHES	6
INDOOR UNIT WIRING.....	8
WIRING REQUIREMENTS	9
CONNECTION DIAGRAMS	10
WIRING DIAGRAMS.....	11
REFRIGERANT LINES.....	12
TROUBLESHOOTING.....	13
DIAGNOSIS AND SOLUTION.....	16
DISASSEMBLY INSTRUCTIONS	35
APPENDICES.....	41

SAFETY CONSIDERATIONS

Installing, starting up, and servicing air-conditioning equipment can be hazardous due to unit pressures, electrical components, and equipment location (roofs, elevated structures, etc.).

Only trained, qualified installers and service mechanics should install, start-up, and service this equipment.

Untrained personnel can perform basic maintenance functions such as coil cleaning. All other operations should be performed by trained service personnel **only**.

When working on the equipment, observe the precautions in the literature and on tags, stickers, and labels attached to the equipment.

Follow all safety codes. Wear safety glasses and work gloves. Keep a quenching cloth and fire extinguisher nearby when brazing. Use care in handling, rigging, and setting bulky equipment.

Read this manual thoroughly and follow all the warnings or cautions included in the literature and attached to the unit. Consult local building codes and the National Electrical Code (NEC) for special requirements.

Recognize safety information. This is the safety-alert symbol .

When you see this symbol on the unit and in instructions or manuals, be alert to the potential for personal injury. Understand these signal words: **DANGER**, **WARNING**, and **CAUTION**.

These words are used with the safety-alert symbol. **DANGER** identifies the most serious of hazards which will result in severe personal injury or death. **WARNING** signifies hazards which could result in personal injury or death. **CAUTION** is used to identify unsafe practices which may result in minor personal injury or product and property damage. **NOTE** is used to highlight suggestions which will result in enhanced installation, reliability, or operation.



WARNING

ELECTRICAL SHOCK HAZARD

Failure to follow this warning could result in personal injury or death. Before installing, modifying, or servicing the unit, the main electrical disconnect switch must be in the **OFF** position.

There may be more than 1 disconnect switch. Lock out and tag switch with a suitable warning label.



WARNING



EXPLOSION HAZARD

Failure to follow this warning could result in death, serious personal injury, and/or property damage.

Never use air or gases containing oxygen for leak testing or operating refrigerant compressors. Pressurized mixtures of air or gases containing oxygen can lead to an explosion.



CAUTION

EQUIPMENT DAMAGE HAZARD

Failure to follow this caution may result in equipment damage or improper operation.

Do not bury more than 36 in. (914 mm) of refrigerant pipe in the ground. If any section of pipe is buried, there must be a 6 in. (152 mm) vertical rise to the valve connections on the outdoor units. If more than the recommended length is buried, refrigerant may migrate to the cooler buried section during the extended periods of unit shutdown. This causes refrigerant slugging and could possibly damage the compressor at start-up.

INTRODUCTION

This service manual provides the necessary information to service, repair, and maintain the indoor units. This manual contains an “DISASSEMBLY INSTRUCTIONS” on page 35 with data required to troubleshoot issues. Use the “TABLE OF CONTENTS” on page 1 to locate a desired topic.

MODEL NUMBER NOMENCLATURE

Table 1 — Unit Sizes

KBTUH	V-PH-HZ	ID MODEL NO.
18	208/230-1-60	DLFUAAQ18XB3
24		DLFUAAQ24XB3
30		DLFUAAQ30XB3
36		DLFUAAQ36XA3
36		DLFUAAQ36XB3
48		DLFUAAQ48XA3
48		DLFUAAQ48XB3
60		DLFUAAQ60XA3

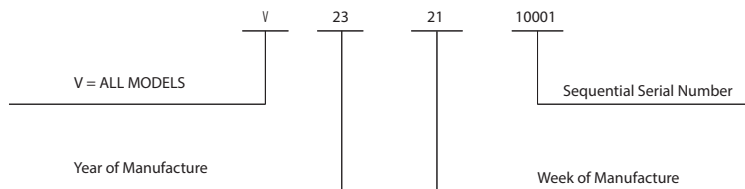
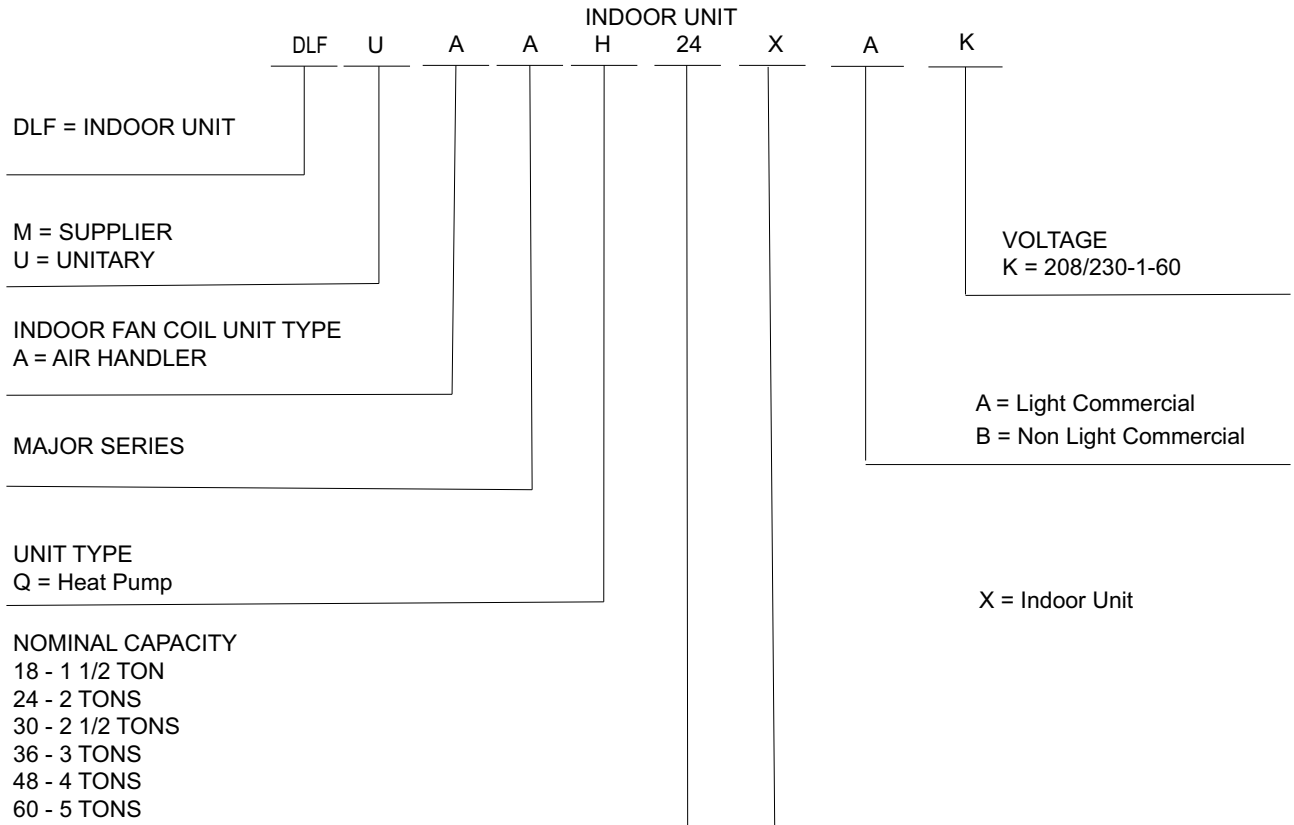

Use of the AHRI Certified TM Mark indicates a manufacturer's participation in the program. For verification of certification for individual products, go to www.ahridirectory.org.



AUXILLIARY CONTACTS FOUND ON THE MAIN BOARD

Work Terminal Port CN23 - Normally Open Dry Contact (Output)

- The **WORK** terminal port is linked to the unit's indoor blower
- When the indoor blower is off, the contact is open
- When the indoor blower is running, the contact is closed
- There is no voltage from CN23, power is provided from the external control system and not from the unit.
- The contacts are rated at 250VAC and 10 AMP maximum
- If an active 24V signal output is required, G and C ports (thermostat connections) may be used instead.

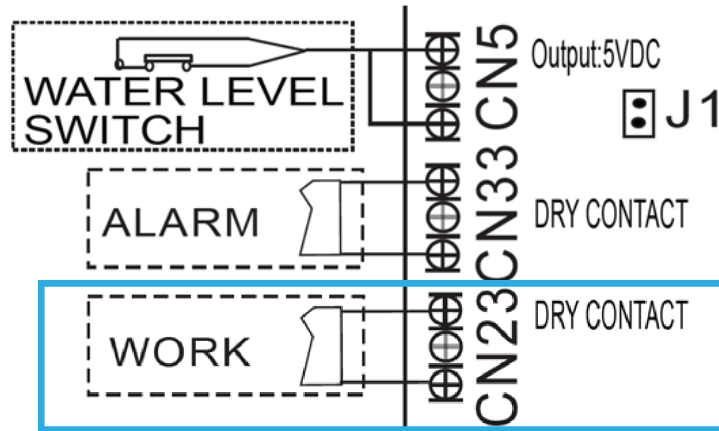

Fig. 1 — Auxiliary Contacts

ALARM Terminal Port CN33 - Normally Open DRY CONTACT (OUTPUT):

- Allows the terminal port to connect to an external **ALARM** interface or annunciator
- There is no voltage from **CN33**, power is provided from the **ALARM** system and not from the unit
- The contacts are rated at **250VAC** and 10 AMP maximum
- When the unit experiences a problem, the contact closes, and the **ALARM** is triggered.

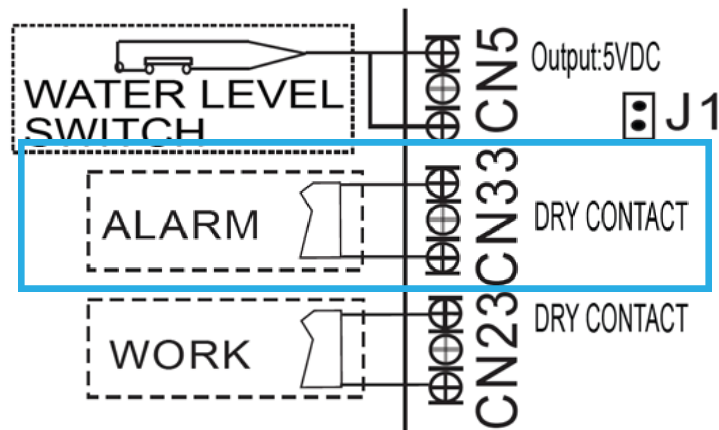

Fig. 2 — Auxiliary Contacts

WATER LEVEL Switch Terminal Port CN5 - SWITCH INPUT:

- To enable this switch, jumper **J1** must be removed
- A field supplied float switch can be directly connected to CN5
- CLOSED contacts = normal
- OPEN contacts = overflow
- When an overflow condition occurs, a signal is sent to the system to turn it off
- Alarm **EE** appears.

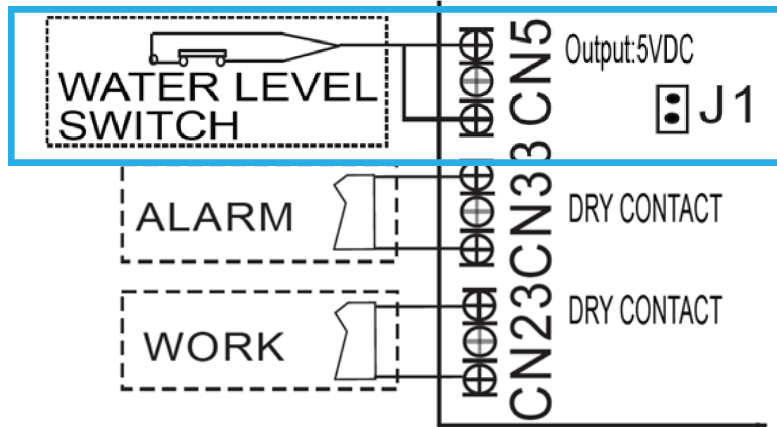

Fig. 3 — Auxiliary Contacts

UV LED Terminal Port CN43 - OUTPUT 24VAC:

- The **UV LED** port is linked to the unit's fan
- When the fan is running, the relay is closed and there is an output of **24VAC** through the contacts that can be used to power a compatible **UV LED LIGHT**
- May also be used to power a pilot relay with **24VAC** coil to control other peripherals

NOTE: After the serial number (0223V26809), the CN43 feature is available.

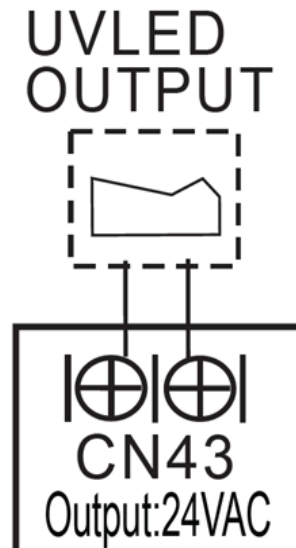

Fig. 4 — Auxiliary Contacts

Auxiliary Contacts found on the 24V interface Board:

Remote control (ON-OFF) terminal port CN2 and jumper JR1 - INPUT:

- Remove the jumper **JR1** to enable the **ON-OFF** function
- When the remote switch is off (**OPEN**); the unit is **OFF**
- When remote switch is on (**CLOSE**); the unit is **ON**
- When the remote switch is close/open, the unit responds to the demand within 2 seconds
- When the remote switch is on, you can use the included remote controller or wired controller to operate the unit as normal.
- When the remote switch off, the unit will not respond to the command from the remote controller or wired controller and a CP code is displayed on the board.

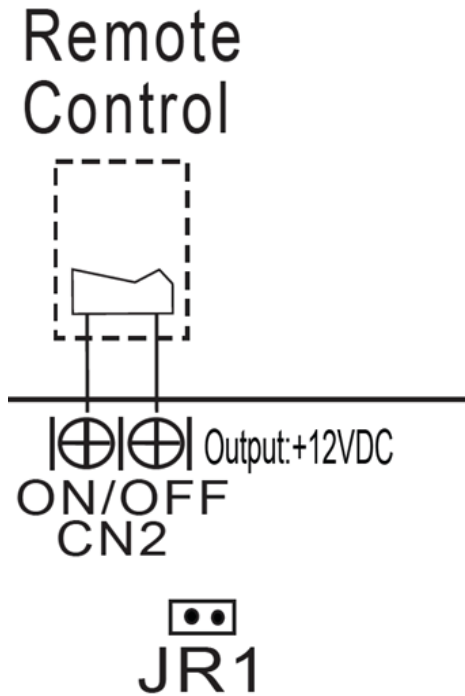

Fig. 5 — Auxiliary Contacts

ROTARY AND DIP SWITCHES

Micro-Switch Setting:

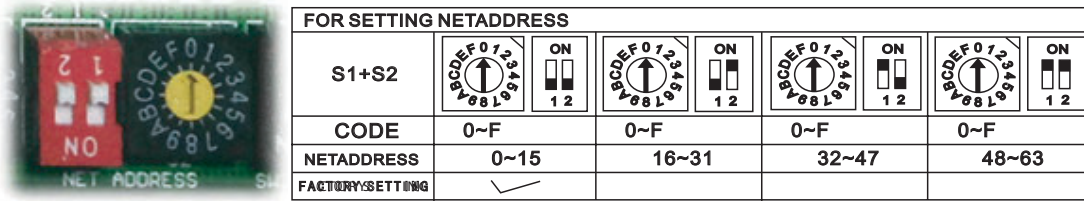

Fig. 6 — Net Address

Micro-switch S1 and dial-switch S2 are for address setting when the user wants to control the unit with a central controller.
 Range: 00-63



Fig. 7 — Unit Configuration

24V THERMOSTATS SETTING						
CODE	0~F	ON-OFF	ON-OFF	ON-OFF	ON-OFF	ON-OFF
FACTORY SETTING	✓	✓	✓	✓	✓	✓

Fig. 8 — Unit Configuration Factory Settings

Connectors

Table 2 — Unit Configuration Settings

Dial Code	Control Scenario	Function	ON	OFF
SW1-1*	OFF for 2 ON for 1 and 3 Please note: SW 1-4 needs to be ON as well for Scenario 3	Control Function	24 V Communication	[Default] Auto Detect or RS485 S1-S2 Communication
SW1-2	1,2	Anti-cold blow protection option	NO	[Default] YES
SW1-3	1,2,3	Single cooling / heating and cooling options	Cooling	[Default] Cooling & Heating
SW1-4*	OFF for 1 and 2 ON for 3 Please note: only active for scenario 3 when used with SW 1-1 ON	Control Function	Scenario 3	[Default] Auto Detect or Scenario 1
SW2-1	1	Compressor Running Compensation (Demand working with heat pump+ Electric heat)	Compressor slower speed	[Default] Faster Compressor
SW2-1	2	Temperature differential to activate first stage auxiliary heat (the GAP of T1 and Ts) Wire controller demand with heat pump + Electric heat working together	2°F	[Default] 4°F
SW2-2	2	Electric heat on delay	YES	[Default] NO
SW2-3	2	Electric auxiliary heating delay to start time	30 minutes	[Default] 15 minutes
SW2-4	2	Compressor/Auxiliary heat outdoor ambient lockout	The compressor does not operate if the outdoor temperature is lower than the temperature represented by S3	[Default] The heater does not operate if the outdoor temperature is greater than the temperature represented by S3
Rotary Switch S3	2	Set outdoor temperature Limitation (for auxiliary heating or compressor)	0 means that the temperature protection is not turned on, the dial range is 1 through F, 1 equals -4°F and it increased up to 46°F	
SW3-1	1	Maximum continuous runtime allowed before system automatically stages up capacity to satisfy set point. This adds 1 to 5°F to the user set point in the calculated control point to increase capacity and satisfy user set point	30 minutes	[Default] 90 minutes
SW3-2	1	Cooling and heating Y/Y2 compressor speed adjustment.	Compressor slower speed	[Default] Faster Compressor
SW3-3	1	Compressor Running (demand working with heat pump+ Electric heat)	Compressor slower speed	[Default] Faster Compressor
SW3-3	2	Temperature differential to activate second stage auxiliary heating (the GAP of T1 and Ts) Wire controller demand with heat pump + Electric heat working together	4°F	[Default] 6°F
SW3-4	1,3	Fan speed of the COOLING mode when 24V thermostat is applied for.	Turbo	Off
SW4	1,2,3	Electric heat nominal CFM adjustment	Available settings are 000/001/010/011. Each digit corresponds an individual switch position (e.g. [SW4-1 OFF , SW4-2 ON , SW4 -3 OFF] = 010).	
S4-1	1,3	Default ON	[Default] For single stage supplemental heat, W1 and W2 are connected	For dual stage supplemental heat, W1 and W2 are controlled independently.
S4-2	1,3	DH function selection	[Default] Dehumidification control not available	Dehumidification feature is enabled through thermostat

***NOTE: Auto detection is available after serial number 0223V26809. With this feature active, the system detects the wiring method according to the 3 control scenarios automatically with all SW1 dip switches set to default.**

NOTE: After the serial number (0223V26809) the auto detection feature is available; prior to the serial number cutoff, the control scenario needs to be set for Scenario 1(SW 1-1 ON) and Scenario 3(SW 1-1 and SW 1-4 ON).

INDOOR UNIT WIRING

Before proceeding with electrical connections, make certain that the supply voltage, frequency, phase, and ampacity are as specified on the unit rating plate. Review the unit wiring label for proper field high and low voltage wiring.

Ensure all electrical connections are in accordance with the NEC and any local codes or ordinances that may apply. Use copper wire only.



CAUTION

PROPERTY DAMAGE HAZARD

Failure to follow this caution may result in product or property damage. If a disconnect switch is to be mounted on the unit, select a location where the drill or fastener will not contact electrical or refrigerant components.



WARNING

ELECTRICAL SHOCK HAZARD

Failure to follow this warning could result in personal injury or death. Field wires on the line side of the disconnect found in the fan coil unit remain live, even when the pull-out is removed. Service and maintenance to incoming wiring cannot be performed until the main disconnect switch (remote to the unit) is turned off.



CAUTION

EQUIPMENT DAMAGE HAZARD

Failure to follow this caution may result in equipment damage or improper operation. Size the wires in accordance with NEC and local codes.

Use the following steps to wire the indoor unit.

NOTE: Wiring in this section is for the base unit ONLY.

1. Prepare the cable for connection.
 - a. Using wire strippers, strip the insulation from both ends of the signal cable to reveal about 1/2 in (12mm) of wire.
 - b. Strip the insulation from both ends of the wires.
 - c. Use a wire crimper to crimp the fork terminals to the ends of the wires.
2. Open the indoor unit's front panel. Use a screwdriver to remove the cover of the electric control box on the indoor unit.
3. Thread the power cable and the signal cable through the wire outlet.
4. Connect the fork terminals to the terminals. Match the wire colors/labels with the labels on the terminal block.
5. Firmly screw the fork terminals of each wire to its corresponding terminal. Refer to the serial number and wiring diagram located on the cover of the electric control box.

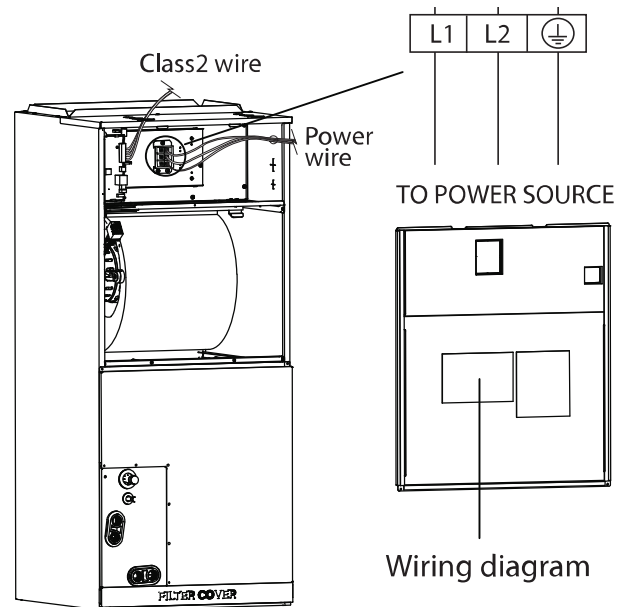

A220802

Fig. 9 — Indoor Unit Power Wiring

NOTE: The electric auxiliary heat wiring diagram is supplied with the accessories. Paste the wiring diagram in the designated position after installing the heat modules.

IMPORTANT: A separate power supply is required for an Auxiliary Electric Heater. Do not power the electric heater directly from the outdoor unit. Always follow the recommendations listed in the installation instructions manuals. Refer to the EHKMB Installation Manual



CAUTION

While connecting the wires, strictly follow the wiring diagram. The refrigerant circuit can become very hot. Keep the interconnection cable away from the copper tube.

6. Clamp down the cable with the cable clamp. The cable must not be loose or put strain on the fork terminals.
7. Reattach the electric box cover.

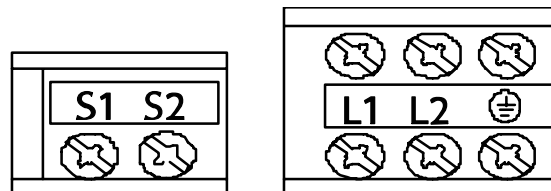

A220826

Fig. 10 — Controls and Power Terminals on Indoor Unit (All Sizes)

WIRING REQUIREMENTS

Size all wires per the NEC (National Electrical Code) or CEC (Canadian Electrical Code) and local codes. Use the electrical data from the outdoor unit (MCA - minimum circuit amps and MOCP - maximum over current protection), to correctly size the wires and the disconnect fuse or breakers respectively.

Communication Wiring: There are two options available to establish communication between the outdoor unit and approved indoor unit.

Table 3 — Options for Establishing Communication

OPTIONS	COMMUNICATION TYPE	RECOMMENDED CABLE SIZE
1	Non-Polarity RS485 Communication (S1 - S2)	16 AWG (stranded shielded)
2	24V communication	18 AWG 8 conductor thermostat wire



WARNING

Refer to the wiring template for the wiring method.

DO NOT connect the power cord to the communication line as this may damage the system.



CAUTION

EQUIPMENT DAMAGE HAZARD

Be sure to comply with local codes while running wire from the indoor unit to the outdoor unit.

Every wire must be connected firmly. Loose wiring may cause the terminal to overheat or result in a unit malfunction. A fire hazard may also exist. Ensure all wiring is tightly connected.

No wire should touch the refrigerant tubing, compressor or any moving parts.

Disconnecting means must be provided and located within sight and readily accessible from the system. Route the connecting cable with conduit through the hole in the conduit panel.

NOTE: Separate power is required for an Auxiliary Electric Heater.



CAUTION

EQUIPMENT DAMAGE HAZARD

Comply with local codes while running wire from the indoor unit to the outdoor unit. Every wire must be connected firmly. Loose wiring may cause the terminal to overheat or result in a unit malfunction. A fire hazard may also exist. Ensure all wiring is tightly connected.

No wire should touch the refrigerant tubing, compressor or any moving parts.

Disconnecting means must be provided and located within sight and readily accessible from the system. Route the connecting cable with conduit through the hole in the conduit panel.

CONNECTION DIAGRAMS

Scenario 1 - Non-Polarity RS485 Communication + 24V Thermostat

This is the preferred method when using a 24V thermostat and when the indoor unit communicates with the outdoor unit via RS485 (S1/S2) protocol.

NOTE: After the serial number (0223V26809), the Auto Discovery feature is available.

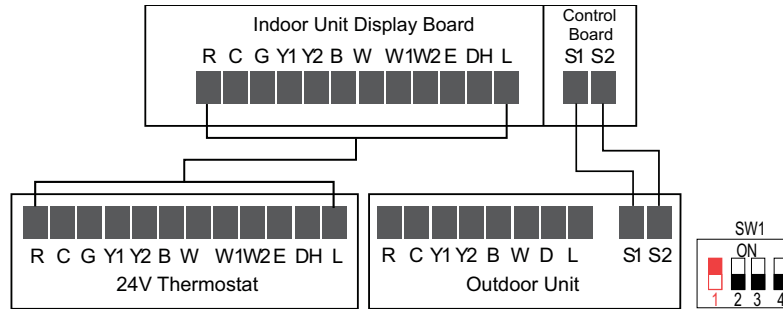
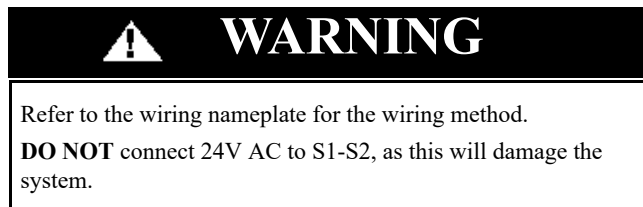

Fig. 11 — Scenario 1



Scenario 2 - Non-Polarity RS485 Communication

This is the preferred method of control with wired controller KSACN1001AAA (Not included)

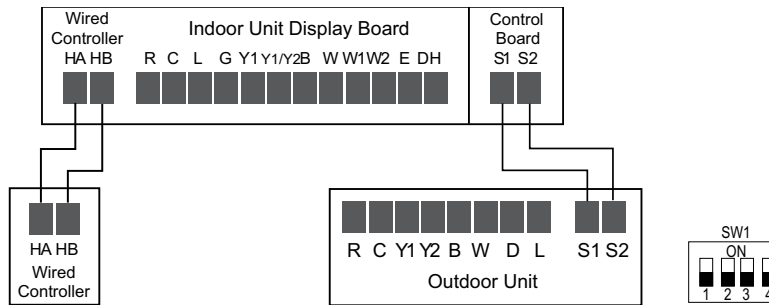

Fig. 12 — Scenario 2

Scenario 3 - Full 24V Communication

This method allows for 24 communication between a 24V thermostat, the indoor unit and the outdoor unit.

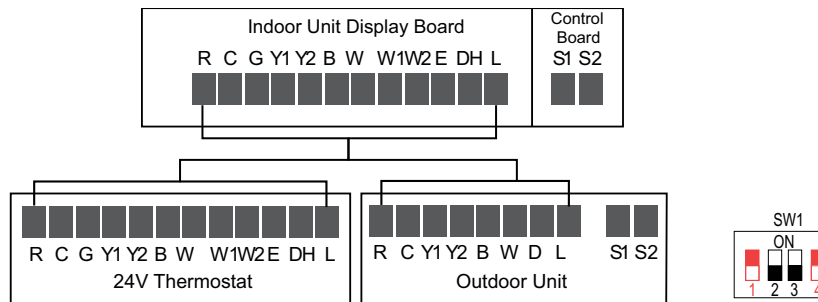

Fig. 13 — Scenario 3

NOTE: For scenarios 2 and 3 - The use of shielded communication or thermostat wire is not required but is recommended where separation from high voltage conductors cannot be maintained, or in areas with high electrical noise. The shield and drain conductor must be grounded at the outdoor unit and stripped back and taped at the indoor unit. Grounding at both ends results in an increase of noise transmitted onto the signal wires.

WIRING DIAGRAMS

NOTE:

- 1.The parts with a dotted line indicates optional features.
- 2.Remove the short connector of JR1 when using the "on-off" function.
- 3.Remove the short connector of J1 when using the "WATER LEVEL SWITCH" function.
4. This symbol indicates the element is optional, the actual shape prevails.

WIRING DIAGRAM

CODE	PART NAME
ECM	INDOOR ECM MOTOR
T1	ROOM TEMP. SENSOR
T2	COIL TEMP> SENSOR
T2A	INDOOR COIL INLET TEMP.SENSOR
T2B	INDOOR COIL OUTLET TEMP.SENSOR

24V THERMOSTATS SETTING

	S3	SW1	SW2	SW3	SW4	S4
CODE	0~F	ON-OFF	ON-OFF	ON-OFF	ON-OFF	ON-OFF
FACTORY SETTING	✓	✓	✓	✓	✓	✓

FOR SETTING NET ADDRESS

	S1+S2				
CODE	0~F	0~F	0~F	0~F	0~F
NETADDRESS	0~15	16~31	32~47	48~63	
FACTORY SETTING	✓				

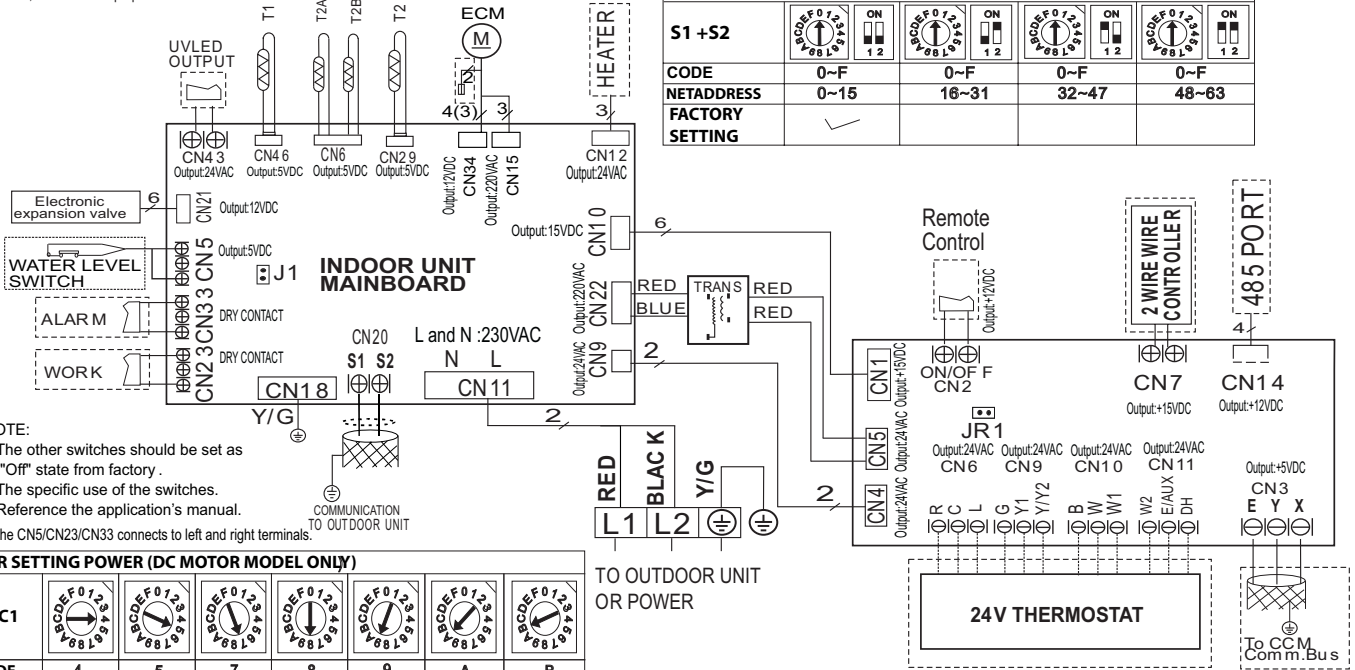

NOTE:

- 1.The other switches should be set as "Off" state from factory.
- 2.The specific use of the switches. Reference the application's manual.
- 3.The CN5/CN23/CN33 connects to left and right terminals.

FOR SETTING POWER (DC MOTOR MODEL ONLY)

ENC1	4	5	7	8	9	A	B
CAPACITY	≤53	54~71	72~90	91~105	106~140	141~160	≥161
FACTORY SETTING	ACCORDING TO RELATED MODEL						

Fig. 14 — Wiring Diagram - All Models

Table 4 — Wiring Diagram - All Models

CODE	CODE2	INDOOR UNIT MAINBOARD CONNECTION
CN5	5	output: 0-5VDC for water level switch connection
CN6	6	output: 5VDC for T2A, T2B (Temperature sensor)
CN9	9	output: 24VAC for 24V Interface
CN10	10	communication: 15VDC for 24V Interface
CN11	11	input: 230VAC High voltage
CN12	12	output: 24VAC for Heaters
CN15	15	output: 220VAC for ECM motor (fan)
CN18	18	output: 0V connection to ground
CN20	20	communication: 0-24VDC Low High voltage
CN22	22	output: 220VAC High voltage to transformer
CN29	29	output: 5VDC for T2 (Temperature sensor)
CN33	33	output: Normally open dry contact
CN34	34	output: 12VDC for ECM motor control
CN46	46	output: 5VDC for T1 (Temperature sensor)
CN43	43	output: 24VAC UVLED
CN23	23	output: Normally open dry contact - work

REFRIGERANT LINES

General refrigerant line sizing

1. The outdoor units are shipped with a full charge of R410A refrigerant. All charges, line sizing, and capacities are based on runs of 25 ft. (7.6 m). For runs over 25 ft. (7.6 m), consult the product data.
2. Minimum refrigerant line length between the indoor and outdoor units is 10 ft. (3 m).
3. Refrigerant lines should not be buried in the ground. If it is necessary to bury the lines, not more than 36 in. (914 mm) should be buried. Provide a minimum 6 in. (152 mm) vertical rise to the service valves to prevent refrigerant migration.
4. Insulate the suction line. Use a minimum of ½ in. (12.7 mm) thick insulation. Closed-cell insulation is recommended in all long-line applications.
5. Special consideration should be given to isolating interconnecting tubing from the building structure. Isolate the tubing so that vibration or noise is not transmitted into the structure.
6. For piping runs greater than 25 ft. (7.6 m), add refrigerant up to the allowable length as specified in the installation manual.

Refrigerant Coil Specifications

Table 5 — Refrigerant Coil Specifications

UNIT SIZE		18	24	30/36/48	60	
DUCTED INDOOR COIL	Number of rows	3			4	5
	Tube pitch (a)x row pitch (b)	in	0.83x0.53			
		mm	21x13.37			
	Fin Spacing	FPI	20			
		mm	1.3	1.3	1.3	1.3
	Fin type	Louvered				
	Fin Material	Gold hydrophilic aluminum				
	Tube outside diameter	inch	0.276			
		mm	7			
	Nominal Tube Wall	mm (inch)	0.00945 (0.24)			
Tube Enhancement	(Yes/ No)	Yes				
Tube Material		Aluminum				
Coil length x height x width	inch	16.34x13.23x1.58x2		16.34x21.5x2.11x2	16.34x21.5x2.63x2	
	mm	415x336x40.11x2		415*546*53.48*2	415*546*66.85*2	
Face area	ft ²	3		4.88	4.88	
Number of circuits		6		10	14	
Metering Device	inch	EEV				
High Burst Pressure	Psi (MPa)	550(3.79)				
Low Burst Pressure	Psi (MPa)	340(2.34)				
Design (high/low) Burst Pressure	Psi	550/340				
Gas Pipe (size – connection type)	In (mm)	Ø3/4" (19)	Ø3/4" (19)	Ø3/4" (19)	Ø7/8" (22)	
Liquid Pipe (size – connection type)	In (mm)	Ø3/8" (9.52)	Ø3/8" (9.52)	Ø3/8" (9.52)	Ø3/8" (9.52)	

TROUBLESHOOTING



WARNING

Turn off all power supplies or disconnect all wires to avoid electric shock. While checking indoor/outdoor PCB, please equip oneself with anti-static gloves or wrist strap to avoid damage to the board.



WARNING

Electricity remains in capacitors even when the power supply is off. Ensure the capacitors are fully discharged before troubleshooting. Please wait five minutes before attempting the service to the PCB.

Error Display (Indoor Unit)

When the indoor unit encounters a recognized error, an error code appears (see Table 6).

Table 6 — Error Display (Indoor Unit)

DISPLAY	ERROR INFORMATION	SOLUTION
EH00	Indoor unit EEPROM parameter error	Page 16
EL01	Indoor / outdoor unit communication error	Page 17
EL1b	Communication malfunction between adapter board and outdoor main board	Page 32
EH03	The indoor fan speed is operating outside of the normal range (for some models)	Page 22
EH60	Indoor room temperature sensor T1 is in open circuit or has short circuited	Page 22
EH61	Evaporator coil temperature sensor T2 is in open circuit or has short circuited	Page 22
EH62	Evaporator coil temperature sensor T2B is in open circuit or has short circuited	Page 22
EH65	Evaporator coil temperature sensor T2A is in open circuit or has short circuited	Page 22
EL0C	Refrigerant Leakage Detection (for some models)	Page 23
EH0b	Communication error between indoor two chips	--
EH0E	Water-level alarm malfunction	Page 24
EC07	The outdoor fan speed is operating outside of the normal range (for some models)	Page 20
EC51	Outdoor unit EEPROM parameter error	--
EC52	Condenser coil temperature sensor T3 is in open circuit or has short circuited	Page 22
EC53	Outdoor room temperature sensor T4 is in open circuit or has short circuited	Page 22
EC54	Compressor discharge temperature sensor TP is in open circuit or has short circuited	Page 22
EC5b	Evaporator coil outlet temperature sensor T2B is in open circuit or has short circuited (for free match indoor units)	--
PC00	IPM malfunction or IGBT over-strong current protection	Page 25
PC01	Over voltage or over low voltage protection	Page 26
PC02	Top temperature protection of compressor or High temperature protection of IPM module	Page 27
PC03	Low pressure protection (for some models)	Page 28
PC04	Inverter compressor drive error	Page 29
EC0d	Outdoor unit malfunction	Page 30
PC0L	Low ambient temperature protection	Page 30
FL09	Mismatch between the new and old platforms	Page 32

For other errors: The display board may display a code or a code undefined by the service manual. Ensure the code is not a temperature reading.

Table 7 — Error Display on Two Way Communication Wired Controller

DISPLAY	MALFUNCTION OR PROTECTION	SOLUTION
EH63	Communication error between wire controller and indoor unit	---

The other error codes displayed on the wire controller are the same from those on the unit.

Quick Maintenance by Error Code

Review Tables 8 - 11 for common faulty parts associated with each error code.

Table 8 — Quick Maintenance by Error Code

PART REQUIRING REPLACEMENT	ERROR CODE									
	EH 00	EL 01	EH 03	EH 60	EH 61	EH 62	EH 65	EL 0C	EH 0E	EC 53
Indoor PCB	√	√	√	√	√	√	√	√	√	X
Outdoor PCB	X	√	X	X	X	X	X	X	X	√
Indoor fan motor	X	X	√	X	X	X	X	X	X	X
T1 sensor	X	X	X	√	X	X	X	X	X	X
T2 Sensor	X	X	X	X	√	X	X	X	X	X
T2B Sensor	X	X	X	X	X	√	X	X	X	X
T2A Sensor	X	X	X	X	X	X	√	X	X	X
T3 Sensor	X	X	X	X	X	X	X	X	X	X
T4 Sensor	X	X	X	X	X	X	X	X	X	√
Reactor	X	√	X	X	X	X	X	X	X	X
Compressor	X	X	X	X	X	X	X	X	X	X
Additional refrigerant	X	X	X	X	X	X	X	√	X	X
Water-level switch	X	X	X	X	X	X	X	X	√	X
Water pump	X	X	X	X	X	X	X	X	√	X

Table 9 — Quick Maintenance by Error Code

PART REQUIRING REPLACEMENT	EC 54	EC 51	EC 5C	EC 52	EC07/71/72/73	PC 00	PC 01	PC 02	PC 04	PC 03
Indoor PCB	X	X	X	X	X	X	X	X	X	X
Outdoor PCB	√	√	√	√	√	√	√	√	√	√
Outdoor fan motor	X	X	X	X	√	√	X	√	√	X
T3 Sensor	X	X	X	√	X	X	X	X	X	X
TP Sensor	√	X	X	X	X	X	X	X	X	X
Pressure sensor	X	X	√	X	X	X	X	X	X	X
Reactor	X	X	X	X	X	X	√	X	X	X
Compressor	X	X	X	X	X	√	X	X	√	X
IPM module board	X	X	X	X	X	√	√	√	√	X
Low pressure protector	X	X	X	X	X	X	X	X	X	√
Additional refrigerant	X	X	X	X	X	X	X	X	X	√

Quick Maintenance by Error Code (Cont.)**Table 10 — Quick Maintenance by Error Code**

PART REQUIRING REPLACEMENT	EL 16	EH 0B	PC 06	PC 08/44/ 49	PC 0A	PC 0F
Indoor PCB	x	√	x	x	x	x
Outdoor PCB	√	x	√	√	√	√
Outdoor fan motor	x	x	x	√	√	x
T3 Sensor	x	x	x	x	√	x
TP Sensor	x	x	√	x	x	x
Pressure sensor	x	x	x	x	x	x
Reactor	x	x	x	√	x	√
Compressor	x	x	x	x	x	x
IPM module board	x	x	x	√	x	x
Data adapter board	√	√	x	x	x	x
High pressure valve assembly	x	x	√	x	x	x
High pressure protector	x	x	x	x	x	x
Low pressure protector	x	x	x	x	x	x
Additional refrigerant	x	x	√	x	√	x

Table 11 — Quick Maintenance by Error Code

PART REQUIRING REPLACEMENT	PC 41	PC 43	PC 10/11/12	PC 30	PC 31	PC 40
Indoor PCB	x	x	x	x	x	x
Outdoor PCB	√	√	√	√	√	√
Outdoor fan motor	x	x	x	√	x	x
T3 Sensor	x	x	x	x	x	x
TP Sensor	x	x	x	x	x	x
Pressure sensor	x	x	x	x	x	x
Reactor	x	x	√	x	x	x
Compressor	x	√	x	x	x	x
IPM module board	x	x	√	x	x	√
Data adapter board	x	x	x	x	x	x
High pressure valve assembly	x	x	x	x	x	x
High pressure protector	x	x	x	√	x	x
Low pressure protector	x	x	x	x	√	x
Additional refrigerant	x	x	x	x	√	x
Electric control box	x	x	x	x	x	√

NOTE: For certain models, the outdoor PCB can not be removed separately. In this case, the outdoor electric control box should be replaced as a whole.

DIAGNOSIS AND SOLUTION

EH00 - EEPROM Parameter Error Diagnosis and Solution

Description: Indoor or outdoor PCB main chip does not receive feedback from the EEPROM chip.

Recommended parts to prepare:

- Indoor PCB
- Outdoor PCB

Troubleshooting and Repair:

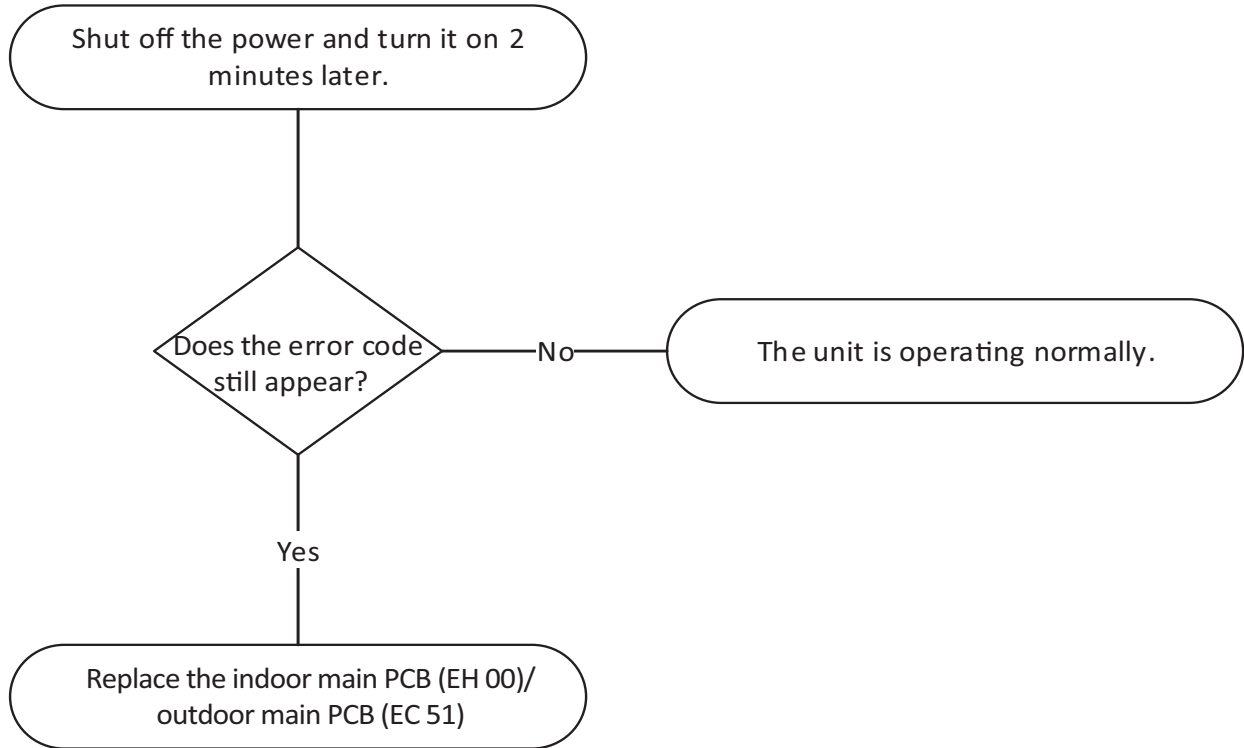

NOTE: The priority is EH00 followed by EC51.

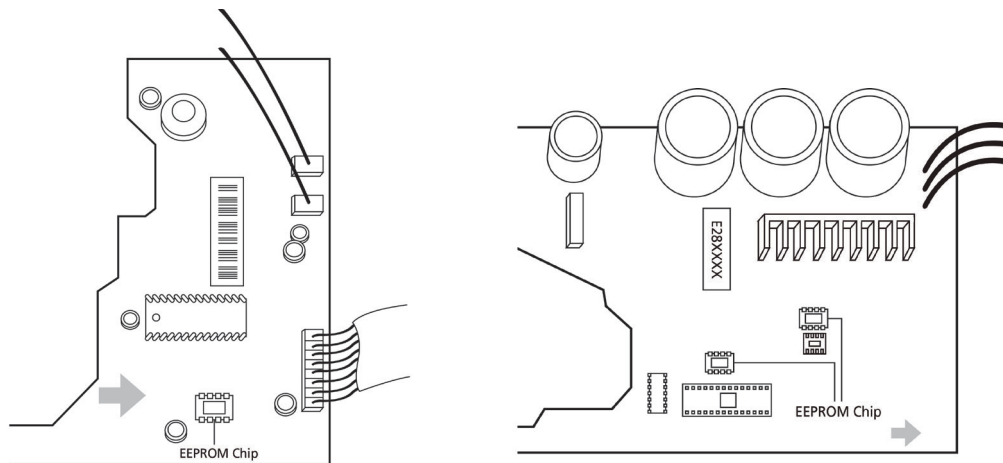

DIAGNOSIS AND SOLUTION (CONT.)**EL01 - Indoor and Outdoor Unit Communication Error Diagnosis and Solution**

Description: Indoor unit can not communicate with the outdoor unit.

Recommended parts to prepare:

- Signal wires
- Magnet ring
- Indoor PCB
- Outdoor PCB

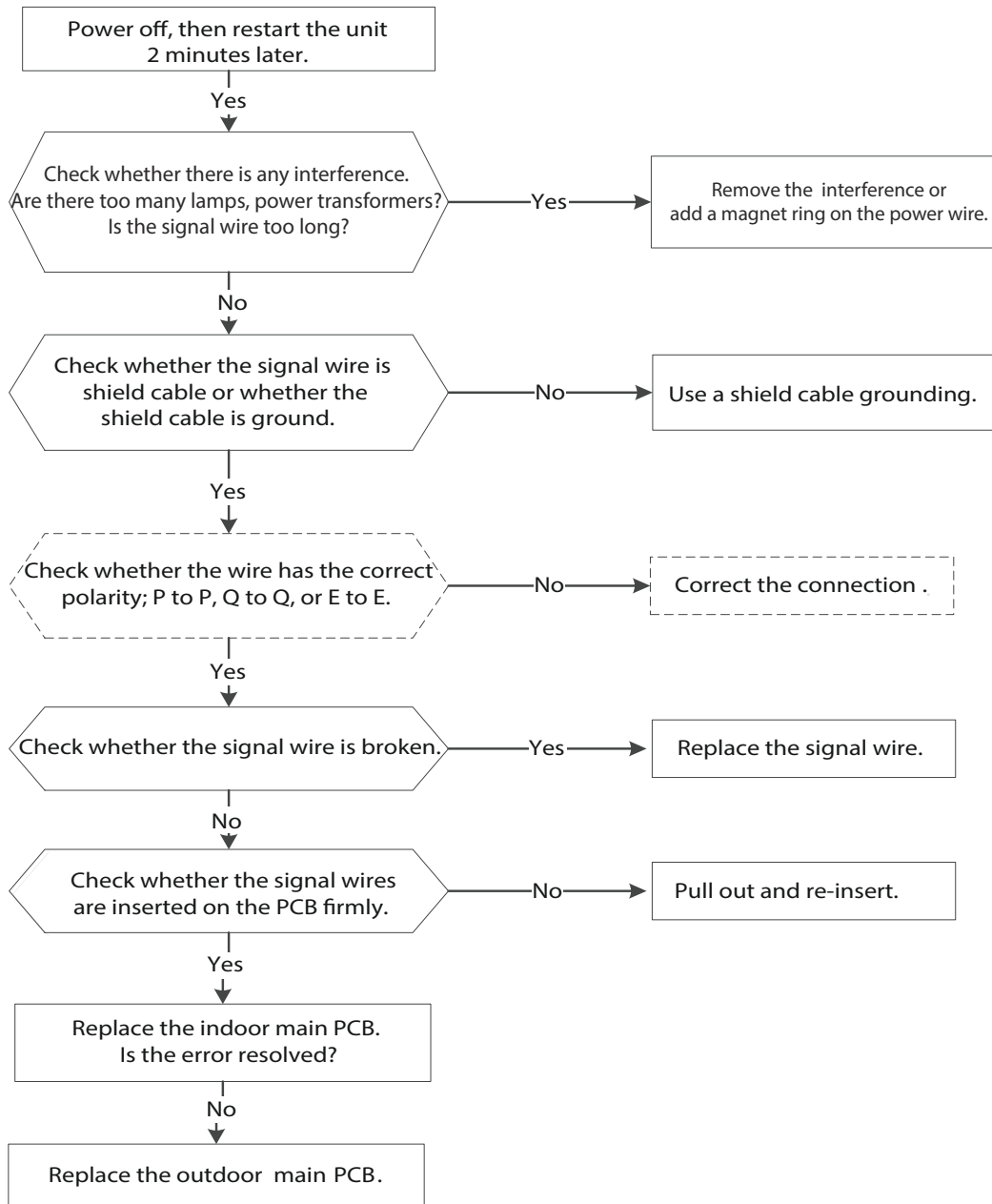
Troubleshooting and Repair:**XYE Communication:**

DIAGNOSIS AND SOLUTION (CONT.)

(S) Current Loop Communication:

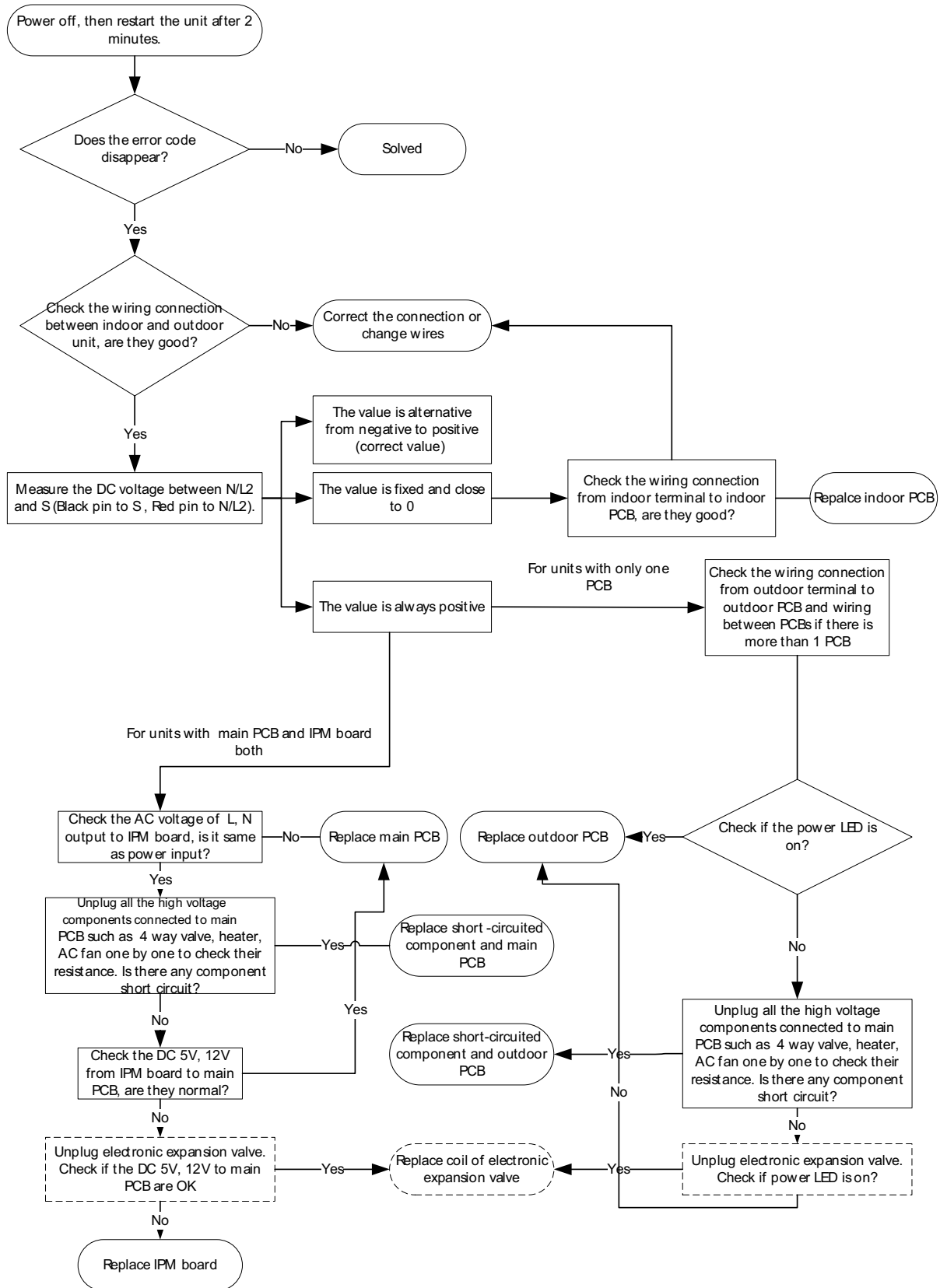

NOTE: For certain models, outdoor PCB could not be removed separately. In this case, the outdoor electric control box should be replaced as a whole.

REMARKS:

- Use a multimeter to test the DC voltage between the 2 port (or S or L2 Terminal) and the 3 port (or N or S Terminal) of the outdoor unit.
- The red pin of the multimeter connects with the 2 port (or S or L2 port) while the black pin is for the 3 port (or N or S Terminal).
- When the unit is normal running, the voltage is moving alternately as positive values and negative values.
- If the outdoor unit malfunctions, the voltage remains a positive value.
- If the indoor unit malfunctions, the voltage does not change.

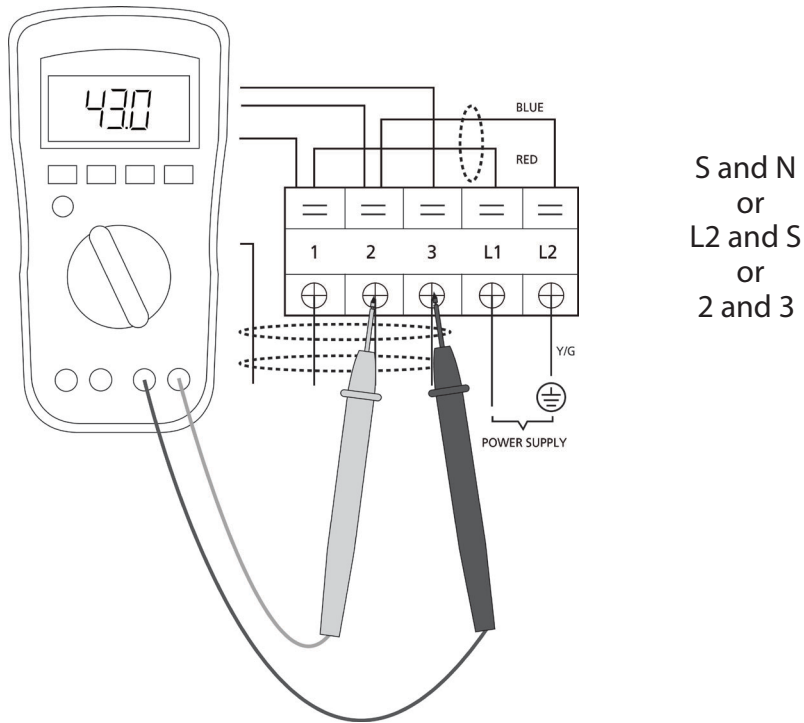

- Use a multimeter to test the reactor resistance which does not connect with the capacitor.
- The normal value should be around zero ohm. Otherwise, the reactor has malfunctioned.

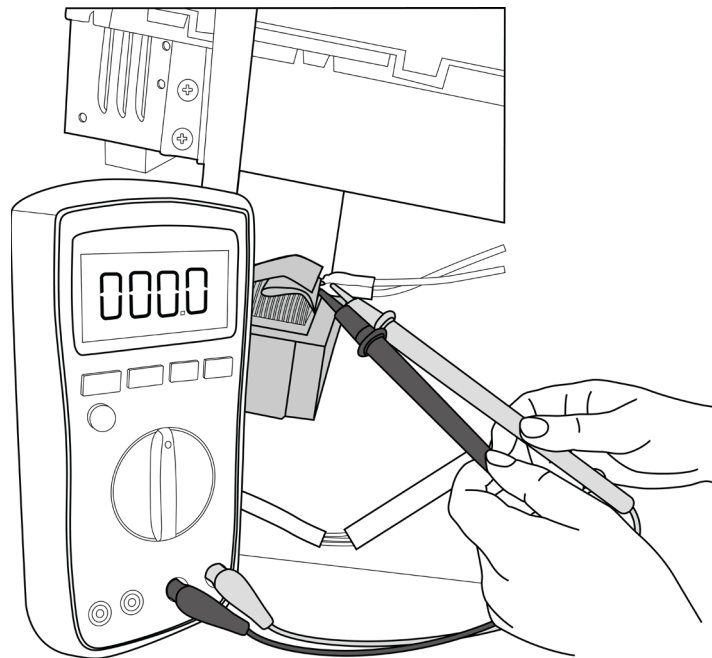

NOTE: The figures and values are for reference only, actual condition and specific value may vary.

DIAGNOSIS AND SOLUTION (CONT.)

EH03 / EC07 - Fan Speed Is Operating Outside of Normal Range / EC 71 Over Current Failure of Outdoor DC Fan Motor / EC73 Zero-speed failure of outdoor DC fan motor Diagnosis and Solution

Description: When the indoor / outdoor fan speed operates at too low or too high a speed for a certain time, the unit ceases operation and the LED displays the failure.

Recommended parts to prepare:

- Connection wires
- Fan assembly
- Fan motor
- PCB

Troubleshooting and Repair:

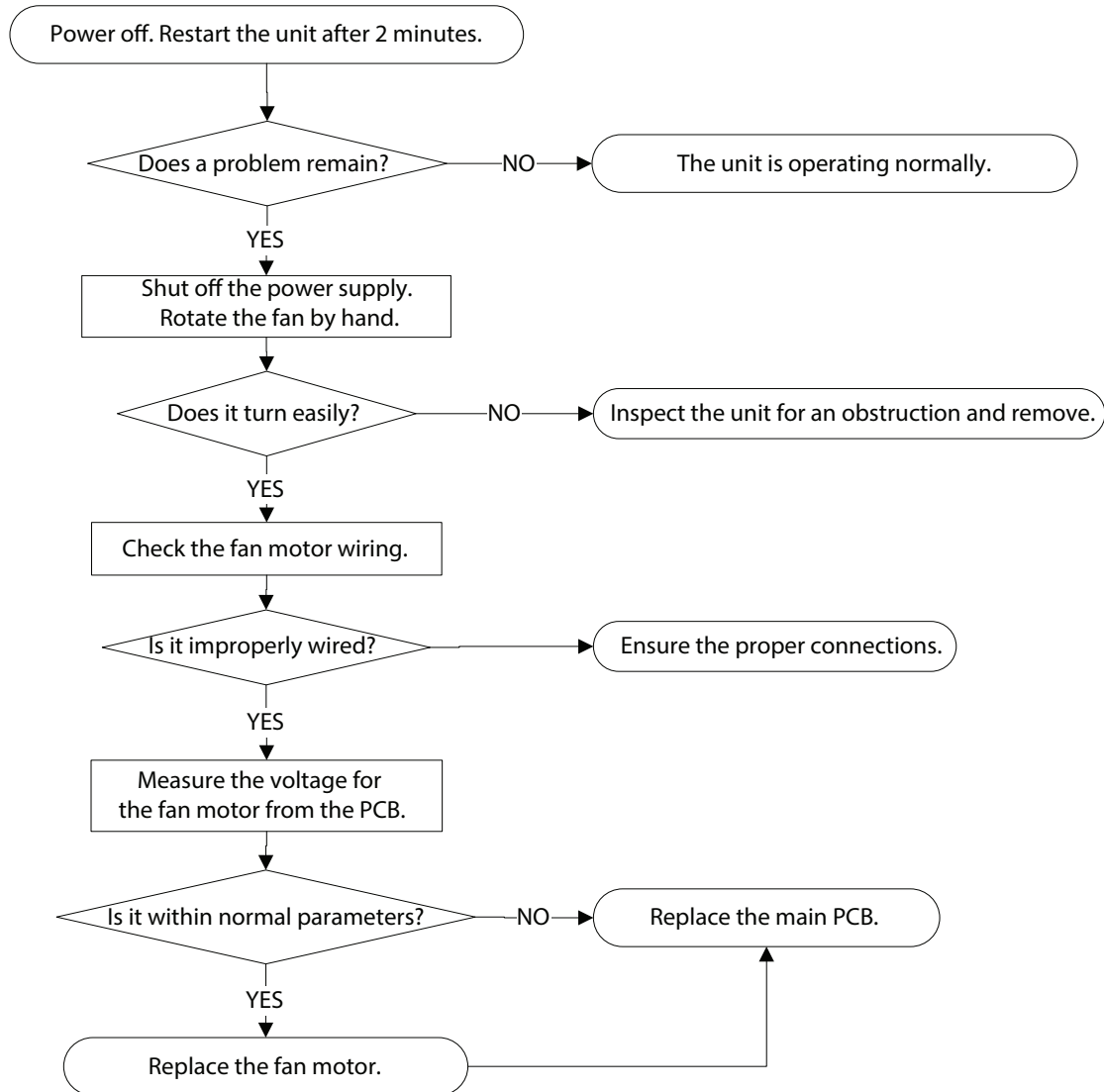

NOTE: For certain models, the outdoor PCB cannot be removed separately. In this case, the outdoor electric control box should be replaced as a whole.

Index:

1. Indoor DC Fan Motor (control chip is on PCB)

Power on the unit and when the unit is in the **STANDBY** mode, measure the pin1&pin2 voltage of **CN15**, and pin3 of **CN34** in the fan motor connector. If the voltage value is not in the range shown in Table 12, the PCB has an issue and needs to be replaced.

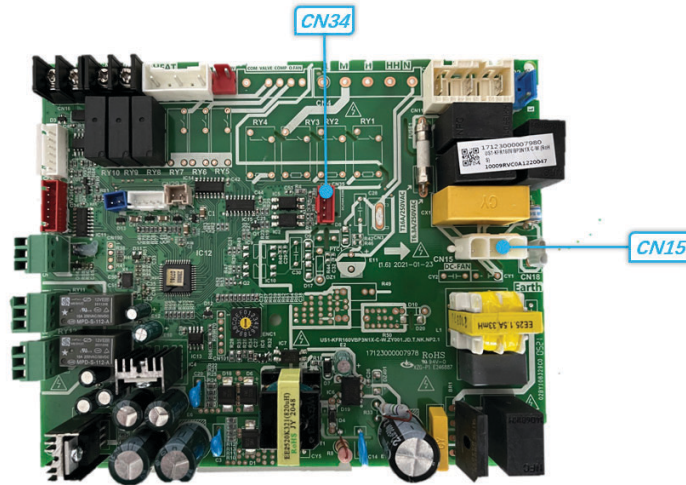

Table 12 — CN34

NO.	COLOR	SIGNAL	VOLTAGE
1	/	/	
2	Black	GND	
3	Orange	PWM	5-12VDC
4	Blue	FG	0-12DVC

Table 13 — CN15

NO.	COLOR	SIGNAL	VOLTAGE
1	Yellow		208/230VAC
2	Black		208/230VAC
3	Yellow-Green	GND	

2. Outdoor DC Fan Motor (control chip is in outdoor PCB)

Release the UVW connector. Measure the resistance of U-V, U-W, V-W. If the resistance is not equal to each other, the fan motor has an issue and needs to be replaced. Otherwise the PCB has an issue and needs to be replaced.

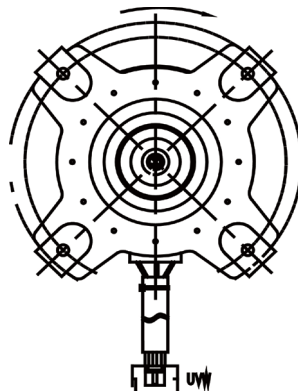

Fig. 15 — Outdoor DC Fan Motor

DIAGNOSIS AND SOLUTION (CONT.)**EH60/EH61/EH62/EH65/EC53/EC52/EC54 - Open Circuit or Short Circuit of Temperature Sensor****Diagnosis and Solution**

Description: If the sampling voltage is lower than 0.06V or higher than 4.94V, the LED displays the failure.

Recommended parts to prepare:

- Connection wires
- Sensors
- PCB

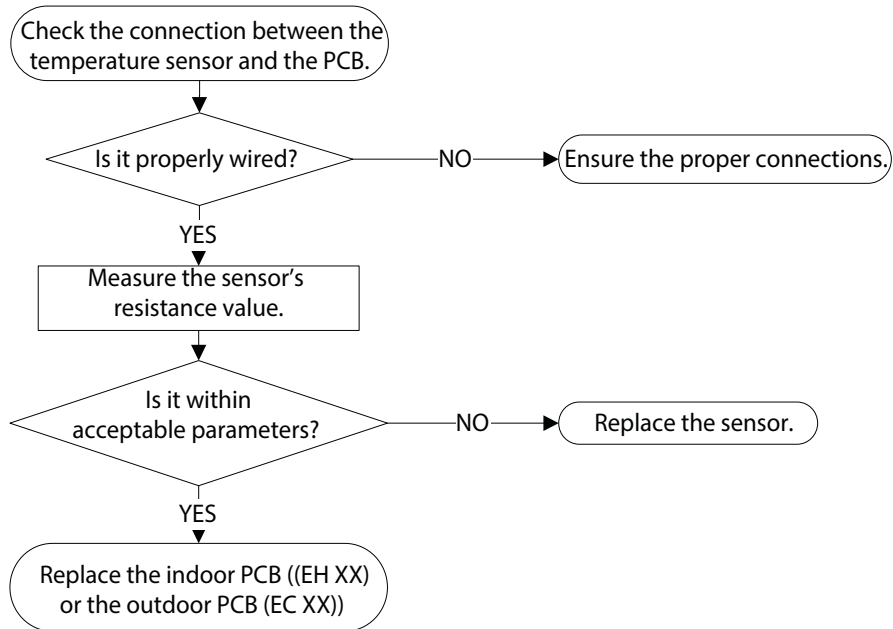
Troubleshooting and Repair:

NOTE: The priority is: EC 52 > EC 53 > EC54 > EC55 > EC 56 > EH 60 > EH61 > EH62 > EH 65.

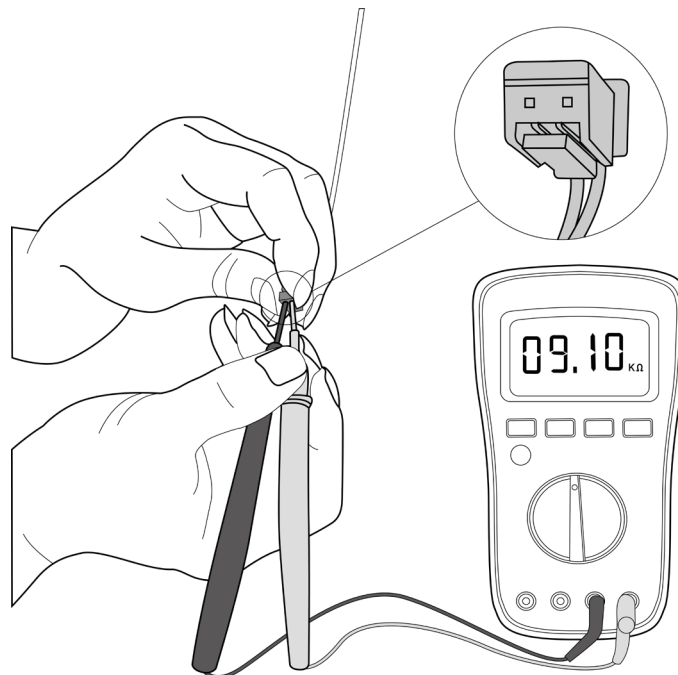

Fig. 16 — Test

NOTE: For certain models, the outdoor PCB could not be removed separately. In this case, the outdoor electric control box should be replaced as a whole. Figure 16 and the value within are for reference only. The actual appearance and value may vary.

DIAGNOSIS AND SOLUTION (CONT.)

EL0C - Refrigerant Leakage Diagnosis and Solution

Description: If the sampling voltage is lower than 0.06V or higher than 4.94V, the LED displays the failure.

Recommended parts to prepare:

- Indoor PCB
- Additional Refrigerant

Troubleshooting and Repair:

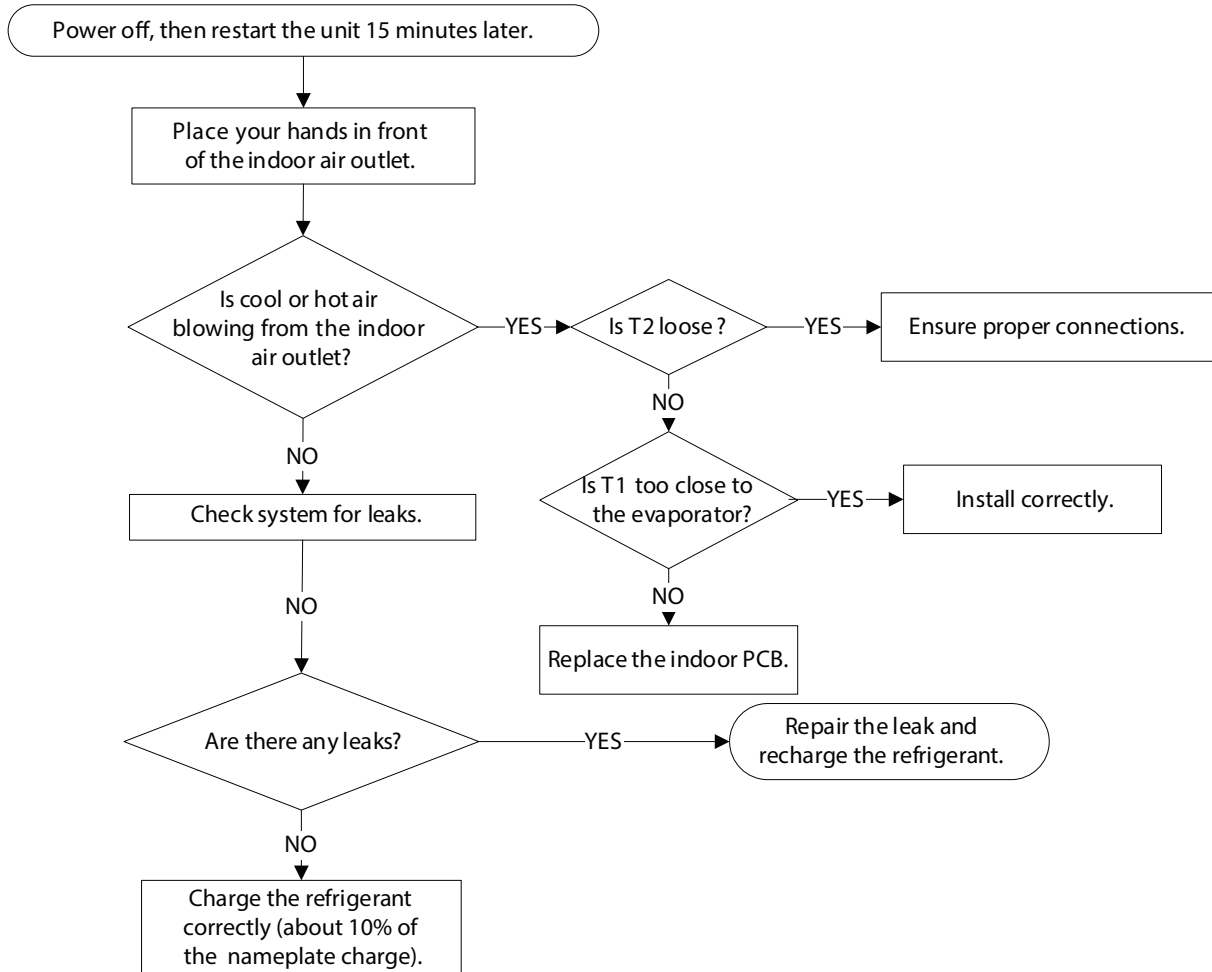

DIAGNOSIS AND SOLUTION (CONT.)

EH0E - Water-Level Alarm Malfunction Diagnosis and Solution

Description: If the sampling voltage is not 5V, the LED displays the failure code.

Recommended parts to prepare:

- Connection wires
- Water-level switch
- Water pump
- Indoor PCB

Troubleshooting and Repair:

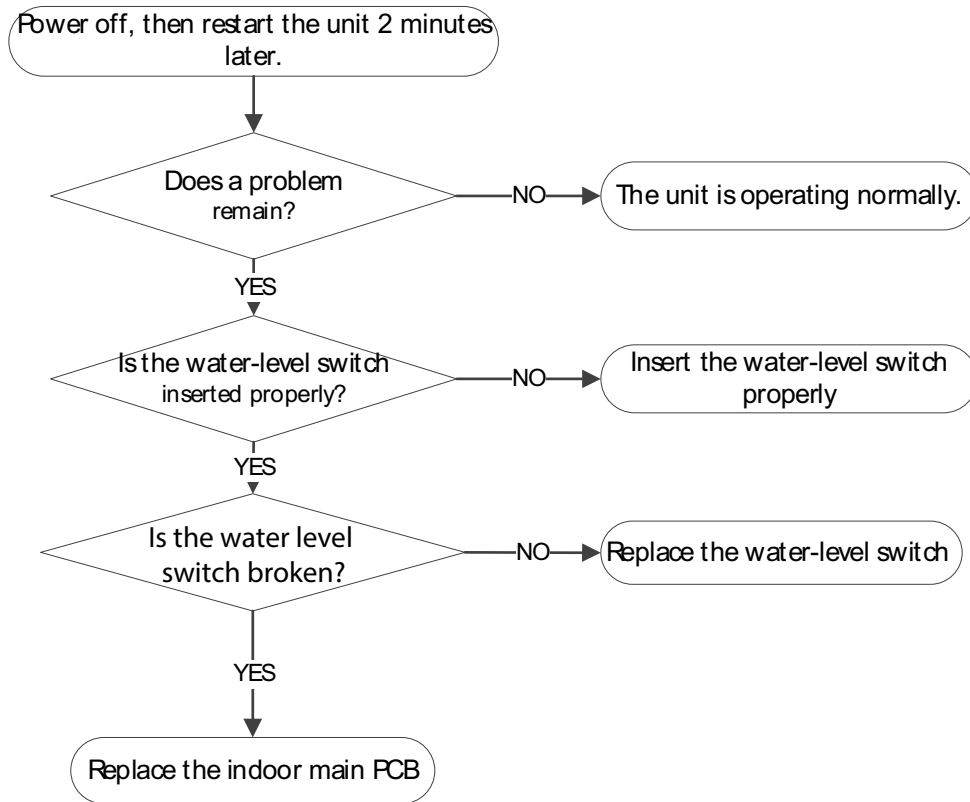

DIAGNOSIS AND SOLUTION (CONT.)

PC 00 - IPM malfunction or IGBT over-strong current protection Diagnosis and Solution

Description: When the voltage signal that the IPM sends to the compressor drive chip is abnormal, the LED displays “PC 00” and the AC turns off.

Recommended parts to prepare:

- Connection wires
- IPM module board
- Outdoor fan assembly
- Compressor
- Outdoor PCB

Troubleshooting and Repair:

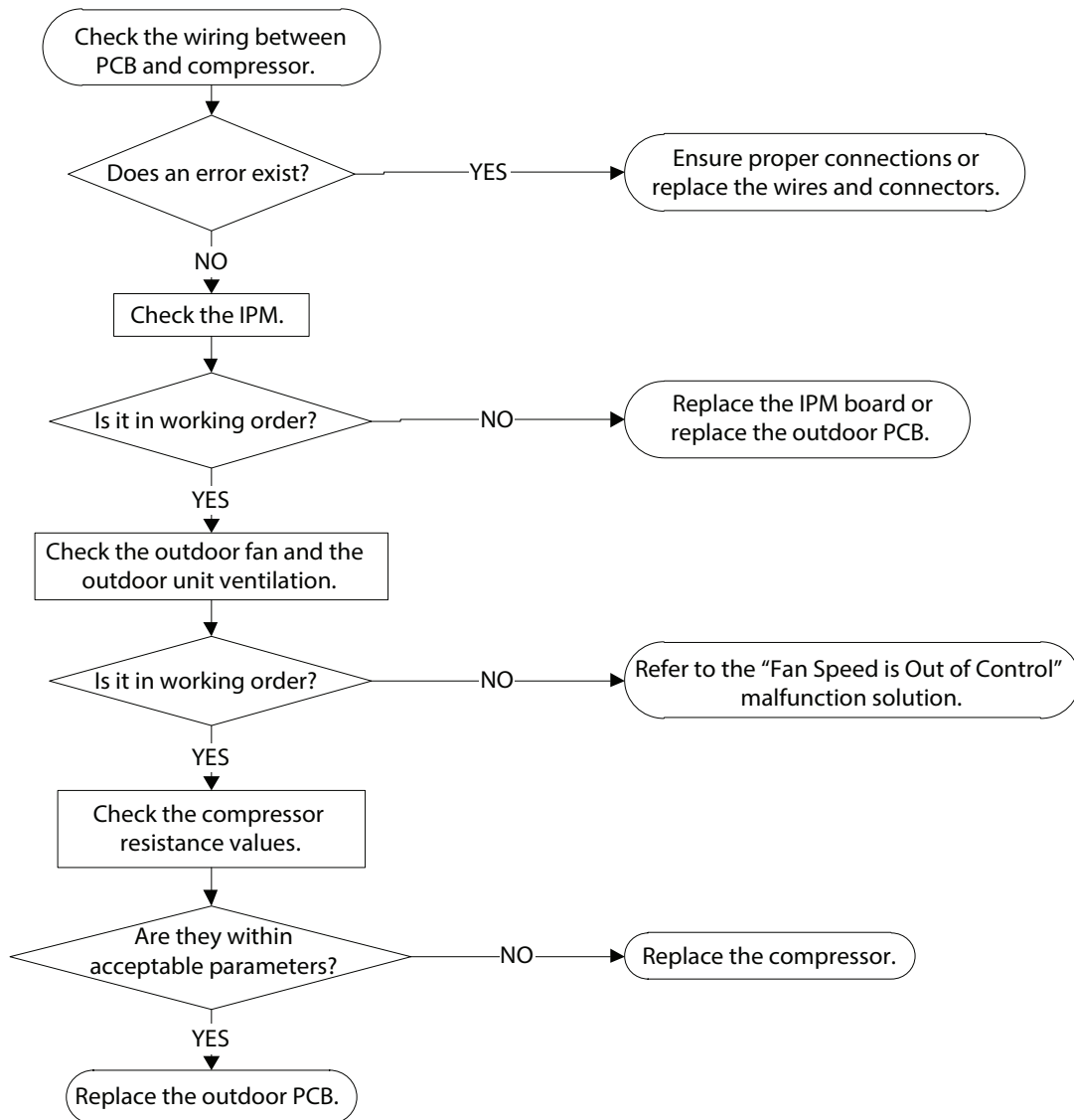

NOTE: For certain models, the outdoor PCB cannot be removed separately. In this case, the outdoor electric control box should be replaced as a whole.

DIAGNOSIS AND SOLUTION (CONT.)

PC 01 - Over voltage or too low voltage protection / PC 10 - Outdoor unit low AC voltage protection / PC 11 - Outdoor unit main control board DC bus high voltage protection / PC 12 (Outdoor unit main control board DC bus high voltage protection / 341 MCE error Diagnosis and Solution

Description: Abnormal increases or decreases in voltage are detected by checking the specified voltage detection circuit.

Recommended parts to prepare:

- Power supply wires
- IPM module board
- PCB
- Reactor

Troubleshooting and Repair:

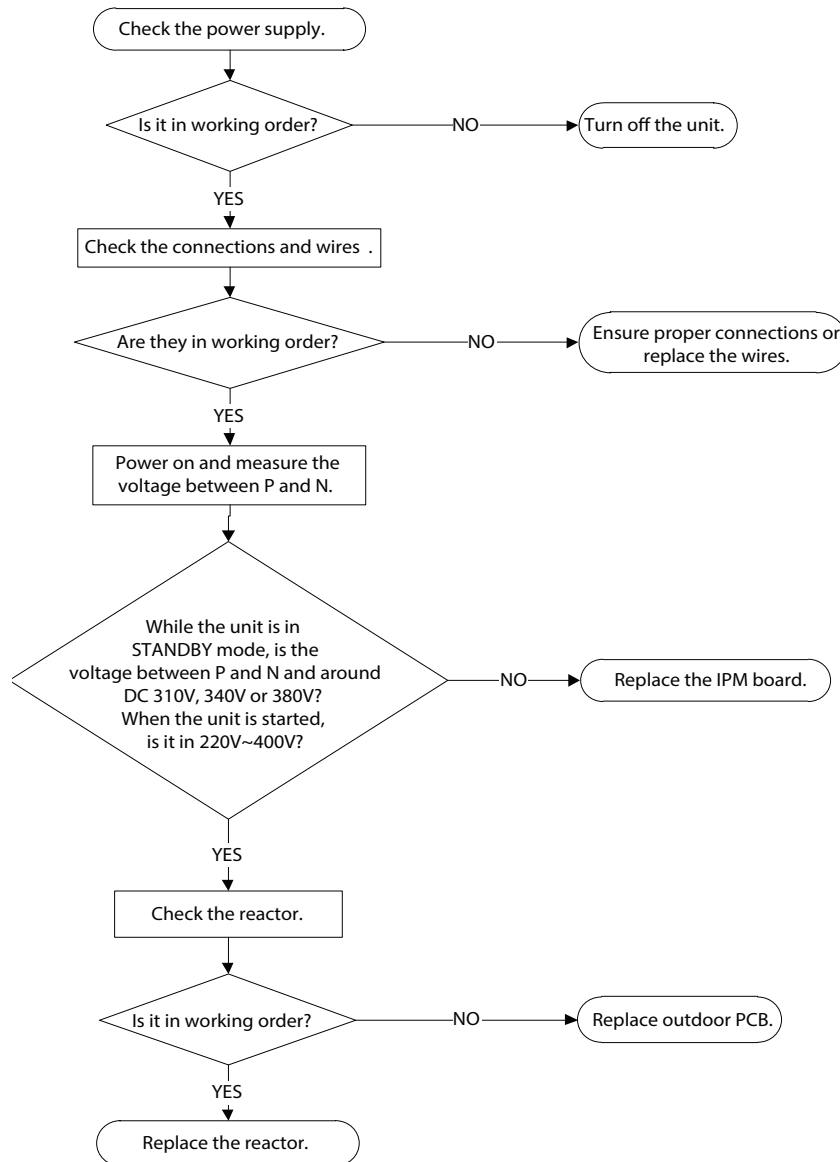

NOTE: For certain models, the outdoor PCB could not be removed separately. In this case, the outdoor electric control box should be replaced as a whole.

DIAGNOSIS AND SOLUTION (CONT.)

PC 02 - Top temperature protection of compressor or High temperature protection of IPM module Diagnosis and Solution

Description: For some models with overload protection, if the sampling voltage is not 5V, the LED displays the failure. If the IPM module temperature is higher than a certain value, the LED displays the failure code.

NOTE: Models without the overload protector should be diagnosed according to Flowchart #2 below.

Recommended parts to prepare:

- Connection wires
- High pressure protector
- IPM module board
- System blocks
- Outdoor PCB

Troubleshooting and Repair:

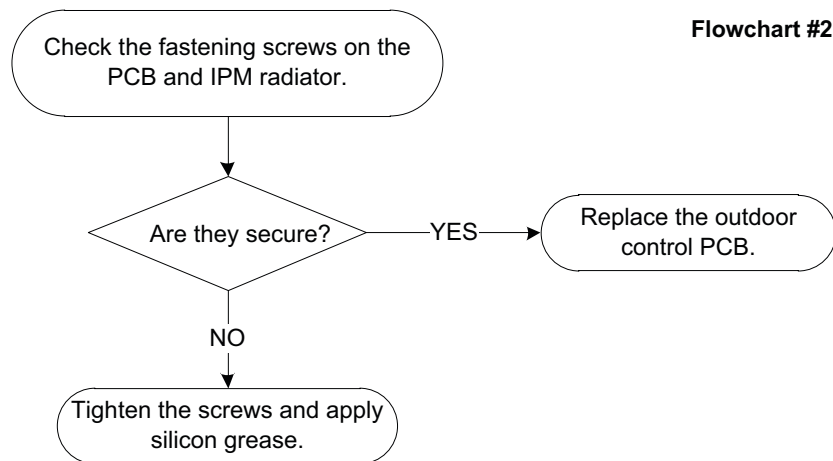
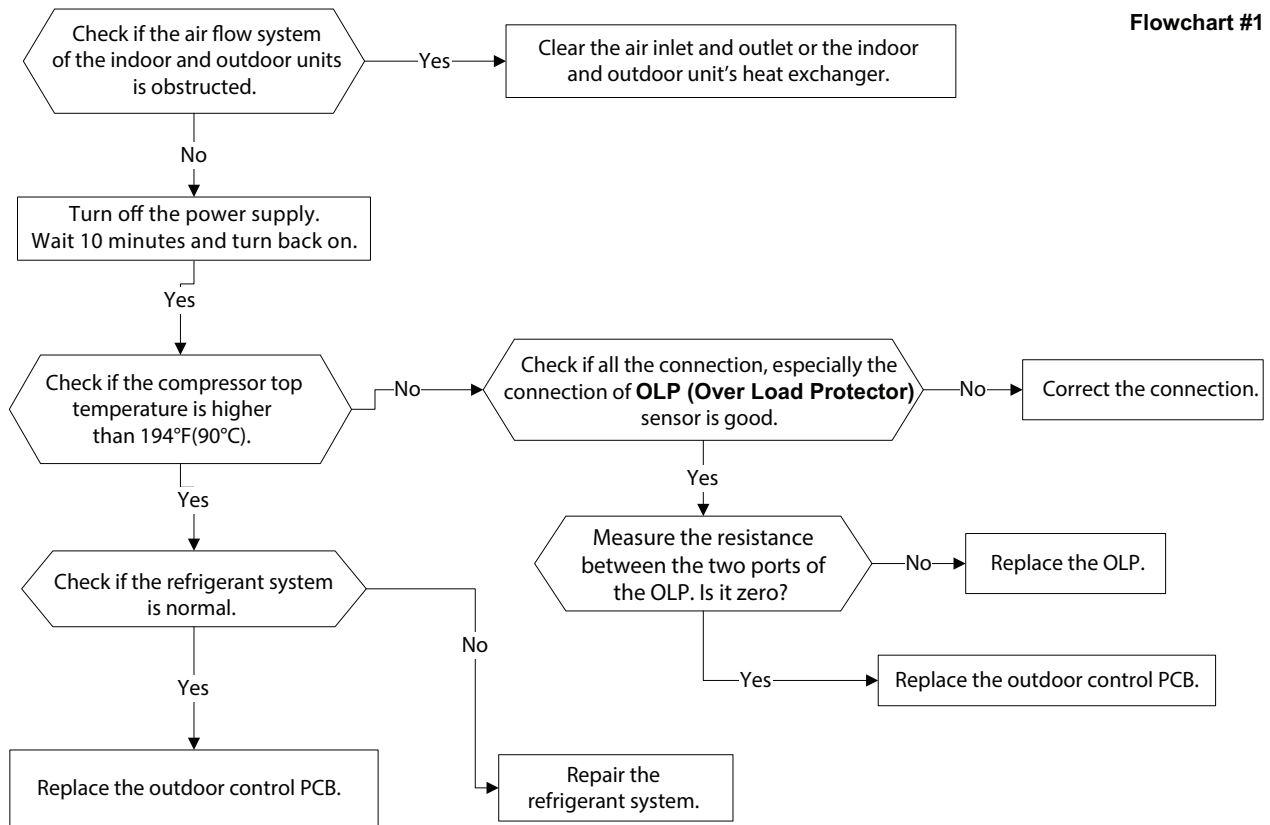

DIAGNOSIS AND SOLUTION (CONT.)

PC 03 - Low Pressure Protection Diagnosis and Solution

Description: If the sampling voltage is not 5V, the LED displays a failure code.

Recommended parts to prepare:

- Connection wires
- Low pressure protector
- Indoor fan assembly
- Outdoor PCB

Troubleshooting and Repair:

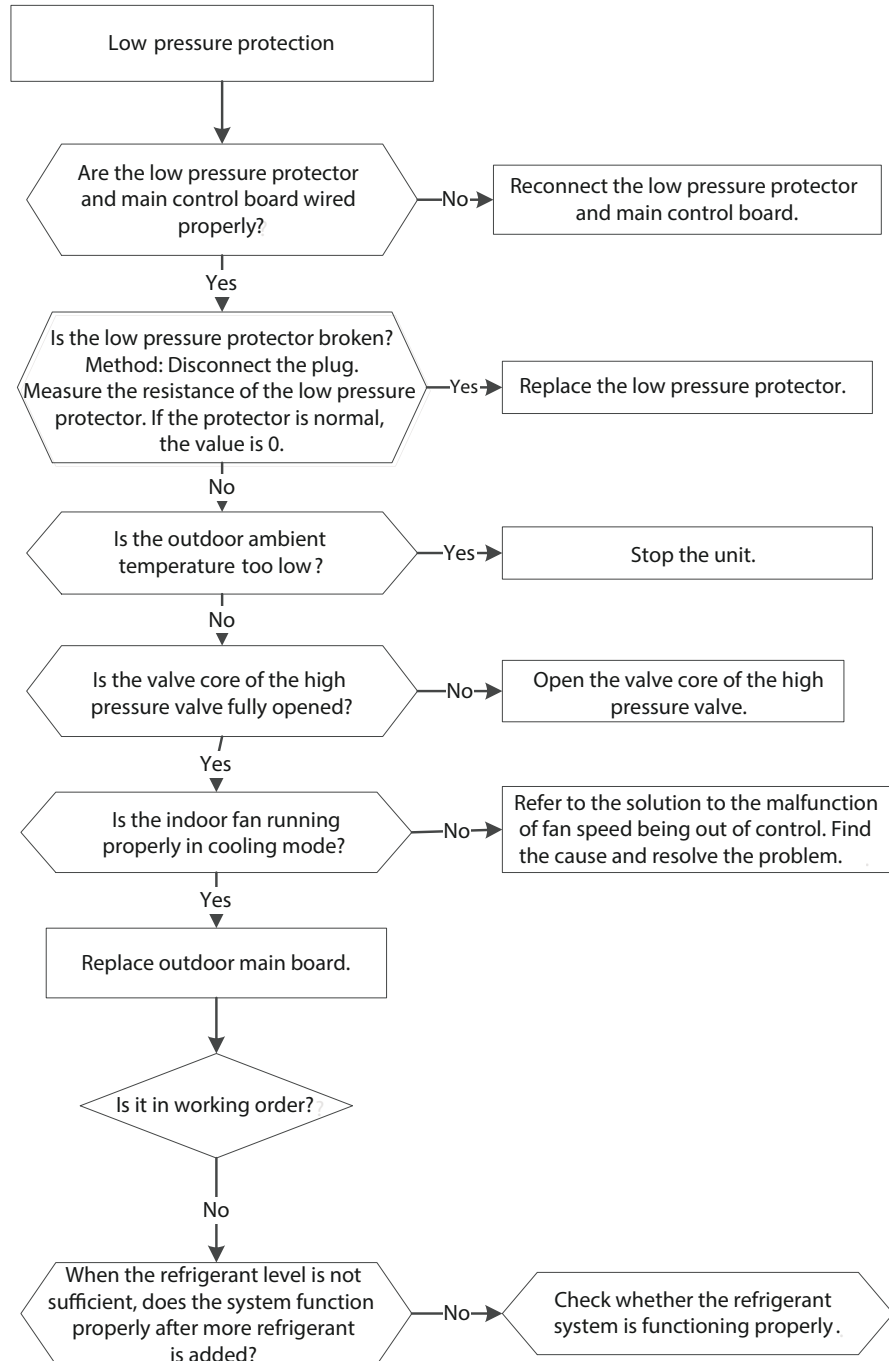

DIAGNOSIS AND SOLUTION (CONT.)

PC 04 - Inverter compressor drive error Diagnosis and Solution

Description: An abnormal inverter compressor drive is detected by a special detection circuit, including the communication signal detection, voltage detection, compressor rotation speed signal detection.

Recommended parts to prepare:

- Connection wires
- IPM module board
- Outdoor fan assembly
- Compressor
- Outdoor PCB

Troubleshooting and Repair:

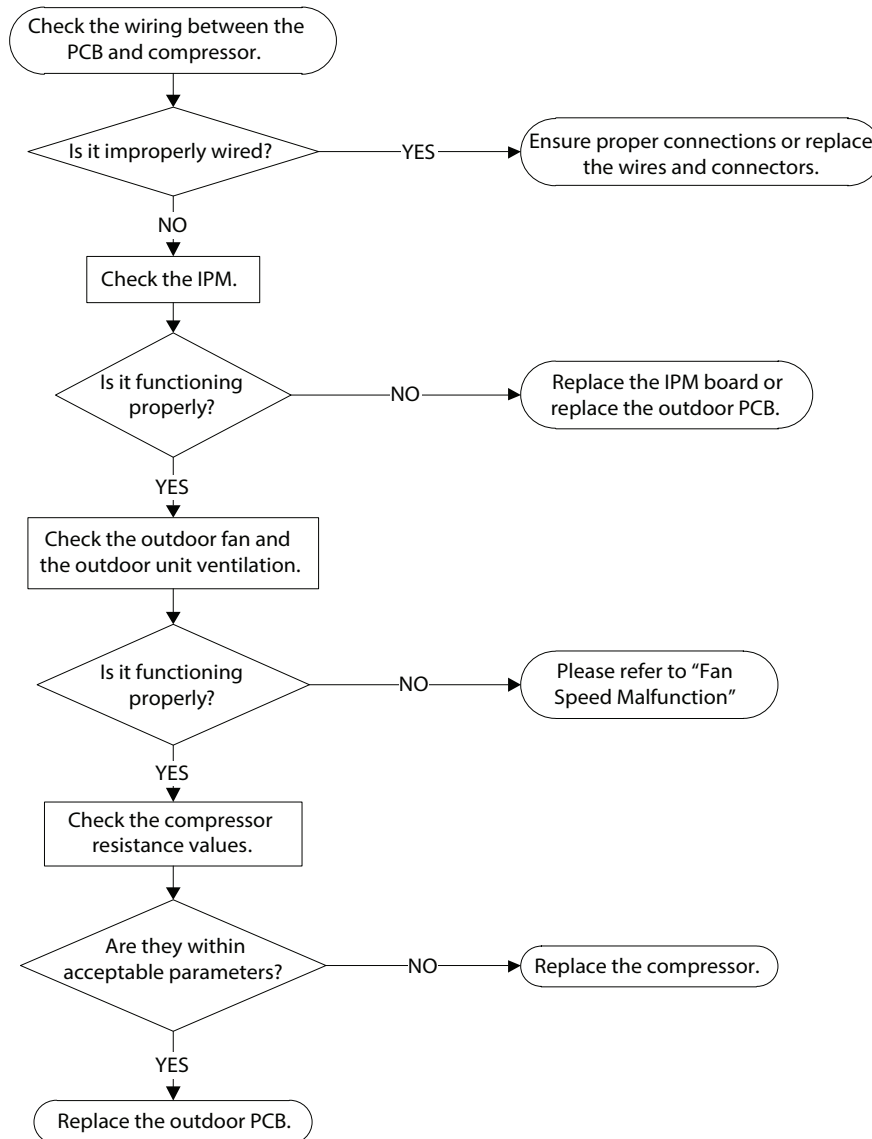

NOTE: For certain models, the outdoor PCB could not be removed separately. In this case, the outdoor electric control box should be replaced as a whole.

DIAGNOSIS AND SOLUTION (CONT.)

EC 0d - Outdoor Unit Malfunction Diagnosis and Solution

Description: The indoor unit detects the outdoor unit has an error.

Recommended parts to prepare:

- Outdoor unit

Troubleshooting and Repair:

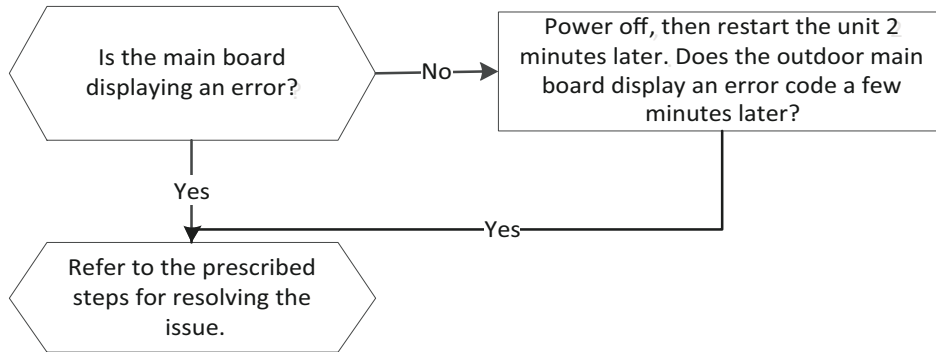

DIAGNOSIS AND SOLUTION (CONT.)

PC 0L - Low ambient temperature protection Diagnosis and Solution

Description: It is a protection function. When the compressor is off, the outdoor ambient temperature(T4) is lower than -31°F (-35°C) for 10 second, the unit stops and displays the failure code. When the compressor is on and the outdoor ambient temperature(T4) is lower than -40°F for 10 seconds, the unit stops and displays the failure code. When the outdoor ambient temperature(T4) is no lower than -25°F for 10 seconds, the unit exits protection.

DIAGNOSIS AND SOLUTION (CONT.)

EH 0b - Communication error between the two indoor chips Diagnosis and Solution

Description: Indoor PCB main chip does not receive feedback from another chip.

Recommended parts to prepare:

- Indoor main board
- Adapter board adapter

Troubleshooting and Repair:

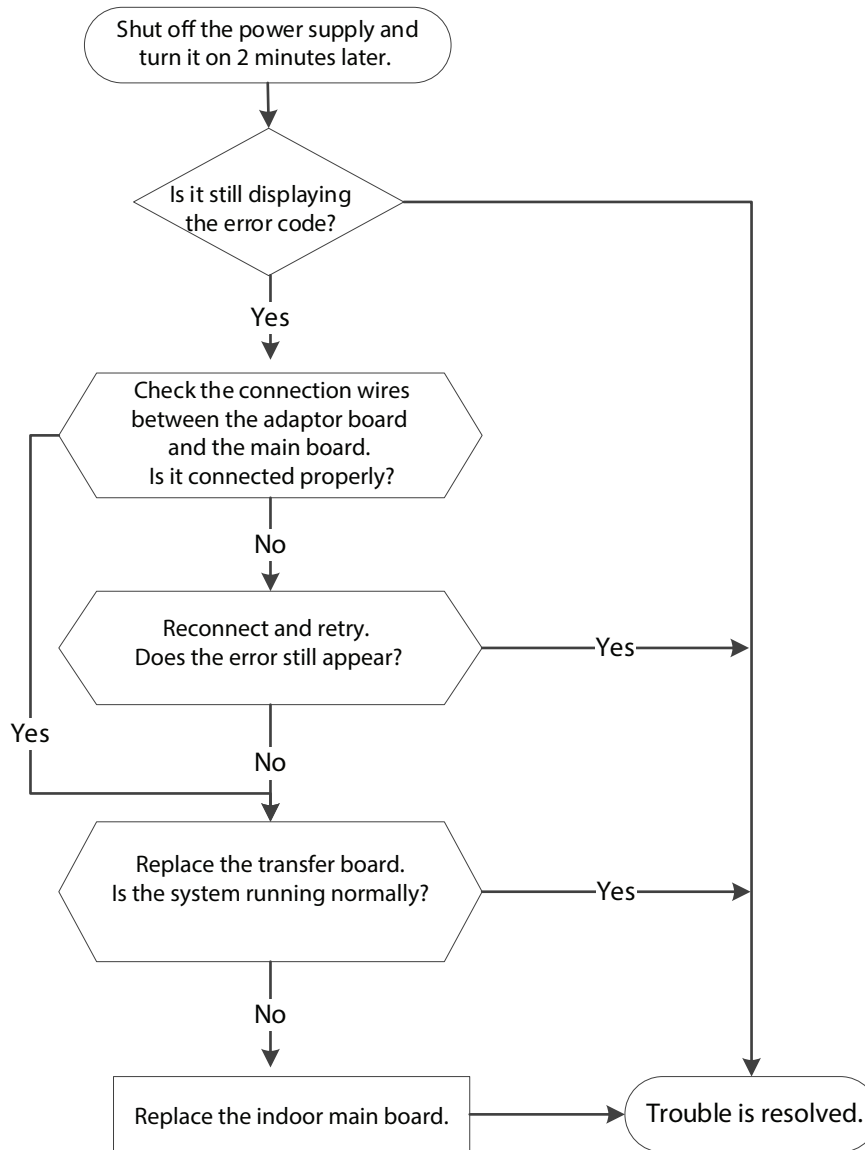

DIAGNOSIS AND SOLUTION (CONT.)

EL 16 - Communication malfunction between adapter board and outdoor main board Diagnosis and Solution

Description: The adapter PCB cannot detect the main control board.

Recommended parts to prepare:

- Connection wires
- Adapter board
- Outdoor main PCB

Troubleshooting and Repair:

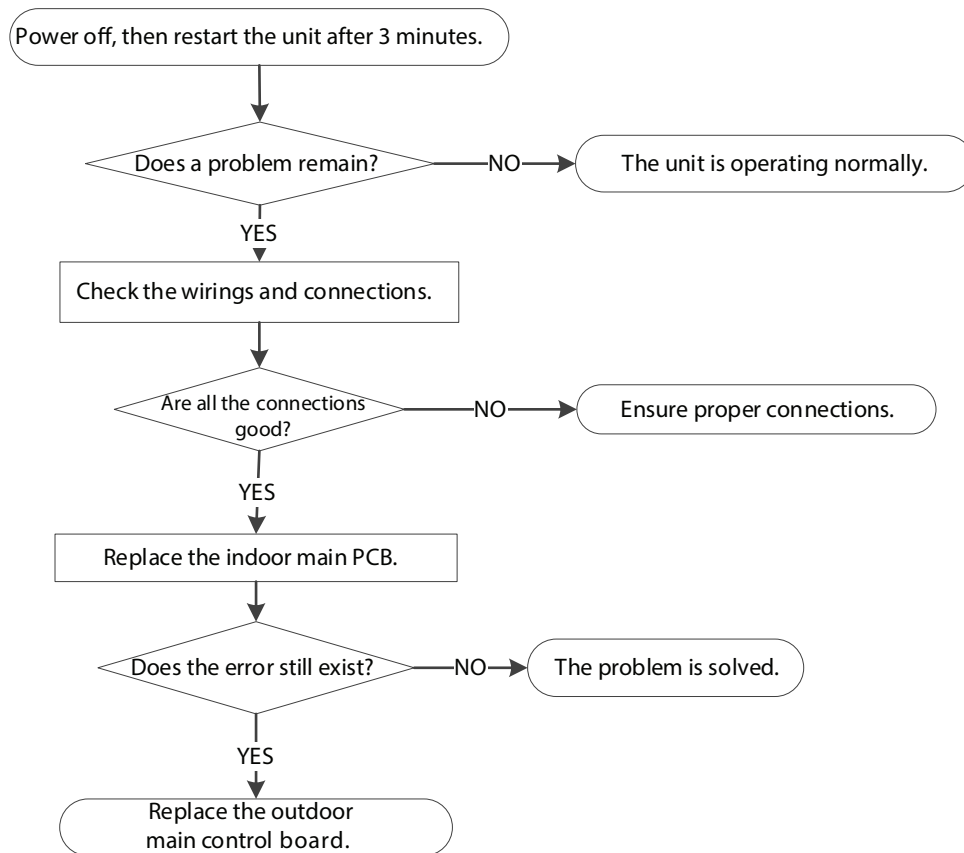

DIAGNOSIS AND SOLUTION (CONT.)

FL 09 - Indoor and outdoor mismatch malfunction Diagnosis and Solution

Description: Indoor and outdoor units are mismatched, the LED displays this code. Replace the matching indoor or outdoor unit.

DIAGNOSIS AND SOLUTION (CONT.)

Temperature Sensor Check

⚠ WARNING

Turn off all power supplies or disconnect all wires to avoid electric shock. Operate after compressor and coil have returned to normal temperature in case of injury.

1. Disconnect the temperature sensor from the PCB.
2. Measure the sensor's resistance value using a multi-meter.
3. Check the corresponding temperature sensor resistance value.

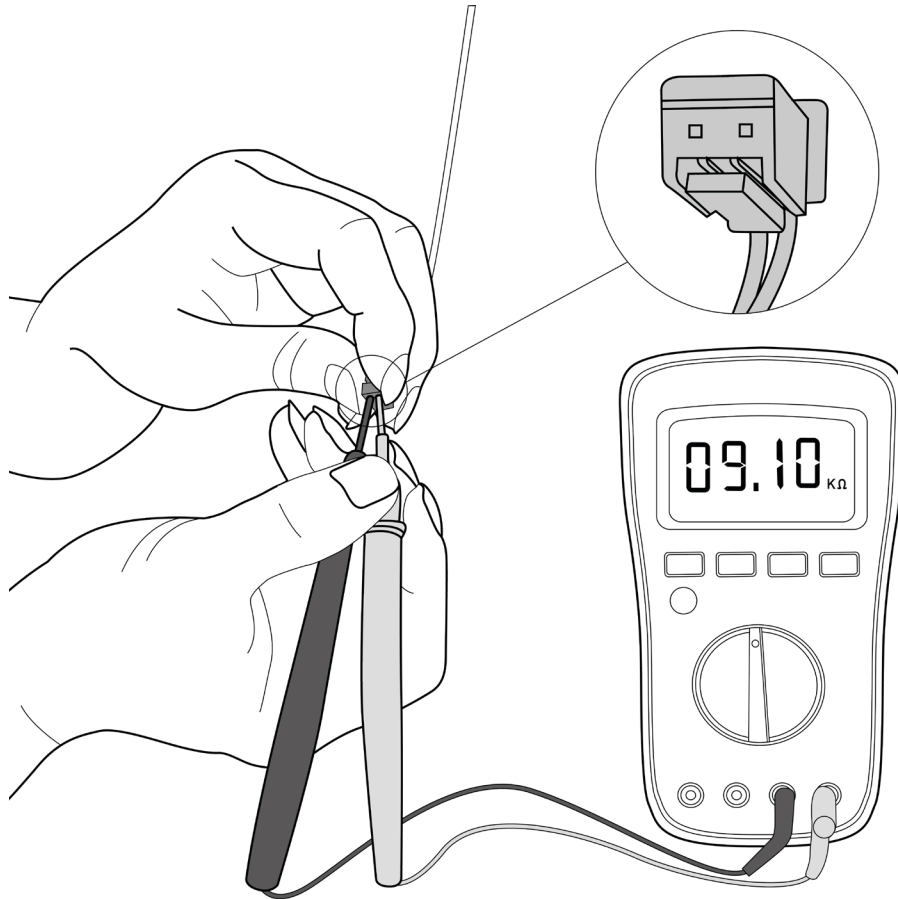

Fig. 17 — Temperature Sensor Check

NOTE: Figure 17 is for reference only. The actual condition and specific value may vary according to temperature.

Compressor Check

1. Disconnect the compressor power cord from the outdoor PCB.
2. Measure the resistance value of each winding using a multi-meter.
3. Check the resistance value of each winding (see Figure 18).

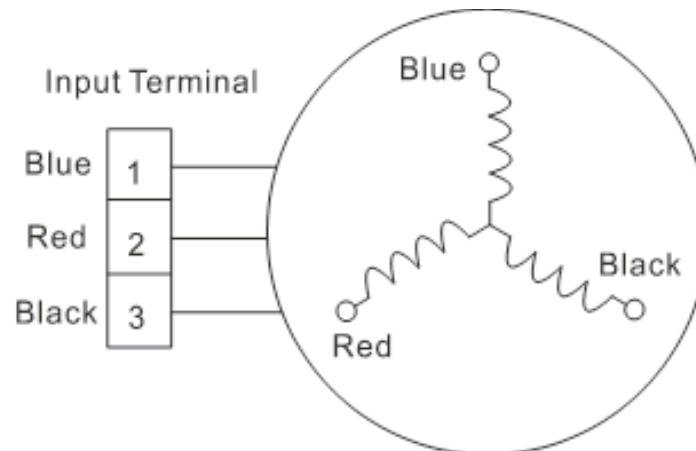
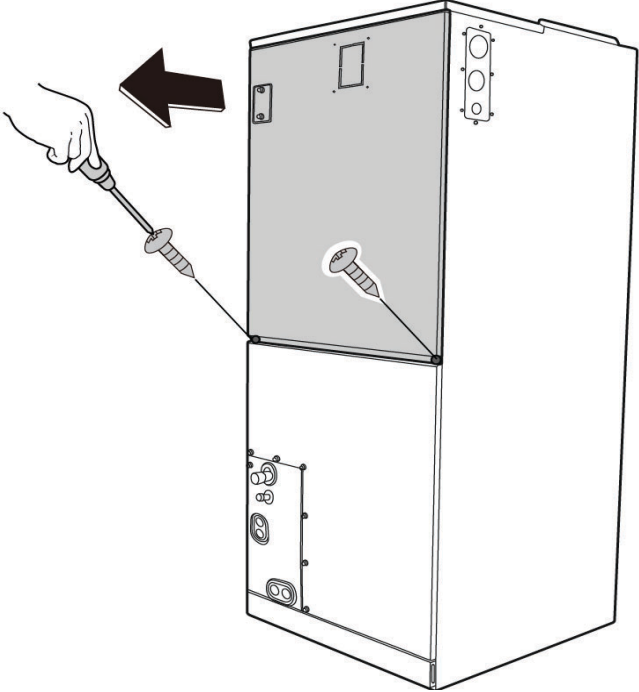
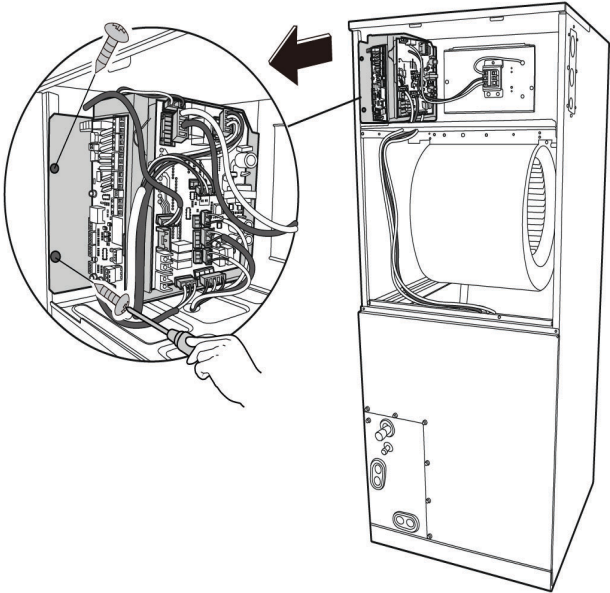

Fig. 18 — Input Terminal (typical)

DISASSEMBLY INSTRUCTIONS

Electrical Parts

(Anti-static gloves must be worn)

PROCEDURES	ILLUSTRATION
<p>1. Remove the 2 screws of the upper cover plate assembly then remove it.</p>	 <p>The illustration shows a hand holding a screwdriver, positioned to remove a screw from the upper cover plate of a control panel. A large black arrow points to the left, indicating the direction of removal. The control panel is shown in a three-quarter view, with the upper cover plate being the focus of the disassembly.</p>
<p>2. Remove 2 screws then unplug the plugs. 3. Pull out the electric control box subassembly.</p>	 <p>The illustration shows the electric control box subassembly being pulled out of the control panel. A large black arrow points to the left, indicating the direction of removal. A circular inset provides a close-up view of the internal wiring and components of the control box, showing a hand pulling it out from the panel.</p>

DISASSEMBLY INSTRUCTIONS (CONT.)

Electrical Parts (Anti-static gloves must be worn) (CONT.)

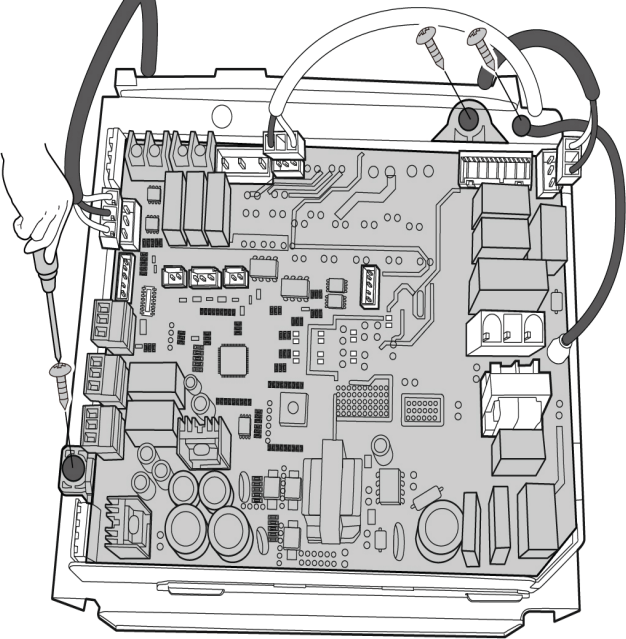
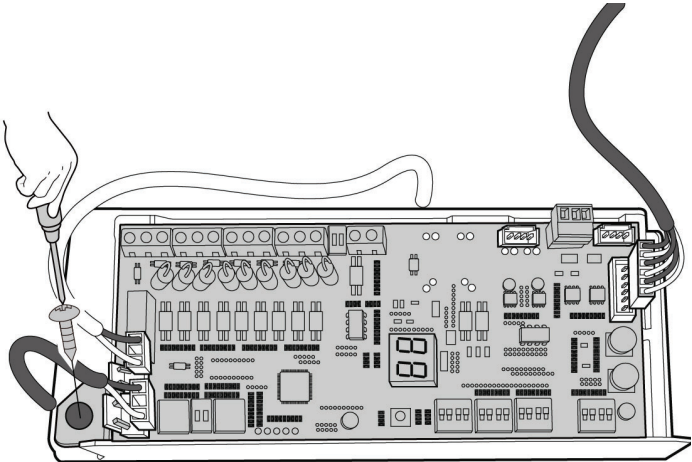
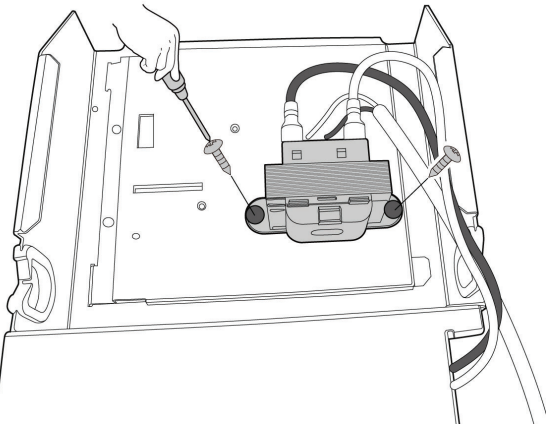
PROCEDURES	ILLUSTRATION
<p>4. Remove the 2 screws and 1 ground screw.</p> <p>5. Unplug the plugs then remove the main control board subassembly.</p>	
<p>6. Release the data transfer module control board screw (1) and remove the board.</p>	
<p>7. Release the 2 screws then remove the transformer.</p>	

DISASSEMBLY INSTRUCTIONS (CONT.)

Fan Motor and Fan

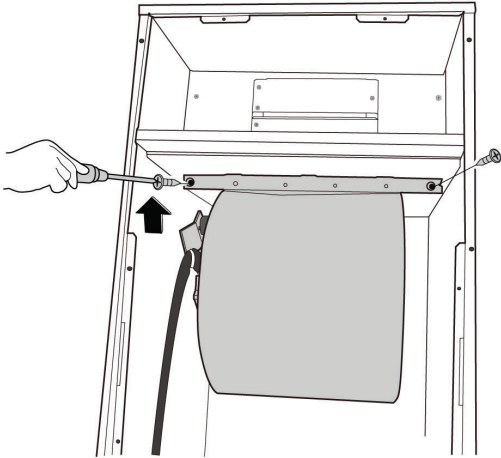
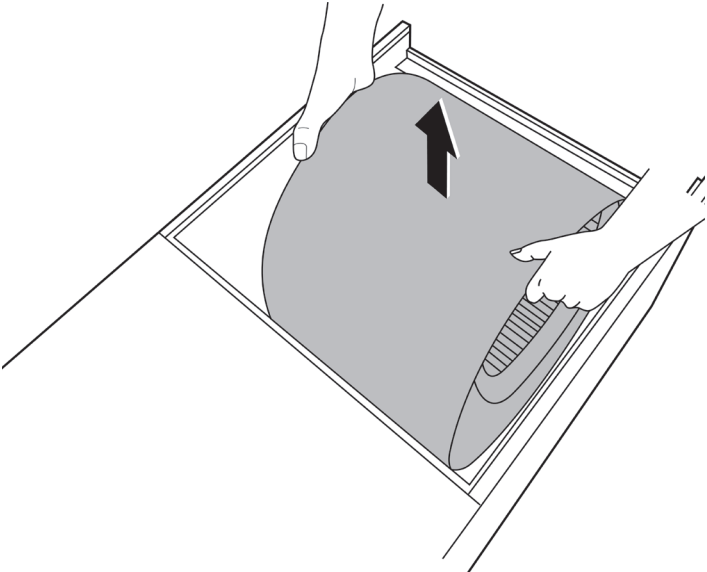
PROCEDURES	ILLUSTRATION
<p>1. Remove the 2 fan assembly screws.</p>	 A line drawing showing the interior of a refrigerator's top compartment. A hand is using a screwdriver to remove a screw from a horizontal metal bar. An arrow points to the screw being removed. A fan assembly is visible below the bar.
<p>2. Remove the fan assembly.</p>	 A line drawing showing a hand lifting the fan assembly out of the refrigerator. The fan assembly is a dark, rounded shape with a fan blade visible. An arrow points upwards, indicating the direction of removal.

DISASSEMBLY INSTRUCTIONS (CONT.)

Fan Motor and Fan (Cont)

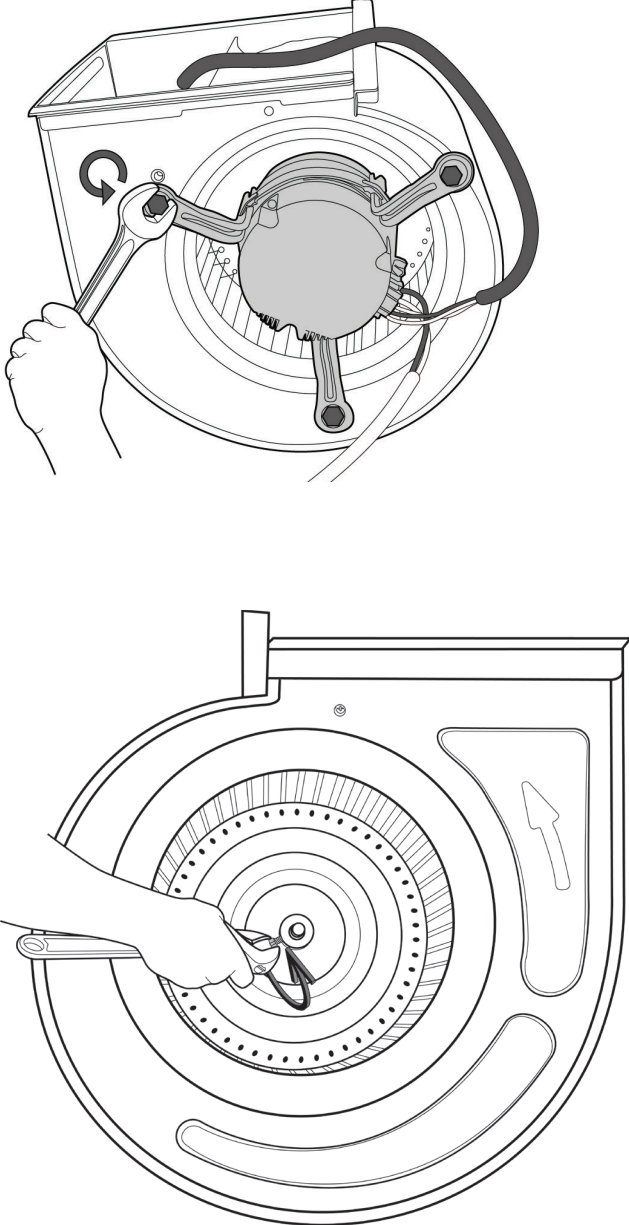
PROCEDURES	ILLUSTRATION
<p>3. Release the 3 nuts securing the fan motor then remove the fan motor.</p> <p>4. Release the 1 nut securing the fan and then remove the fan.</p>	 <p>The top illustration shows a hand using a wrench to turn a nut on the fan motor assembly. A curved arrow indicates the direction of rotation. The bottom illustration shows a hand using a screwdriver to turn a nut on the fan blades. An arrow on the fan housing points upwards, indicating the direction of the fan's rotation.</p>

DISASSEMBLY INSTRUCTIONS (CONT.)

Evaporator

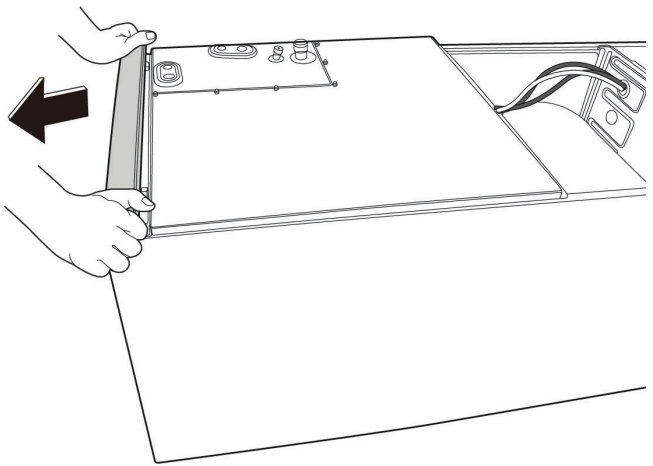
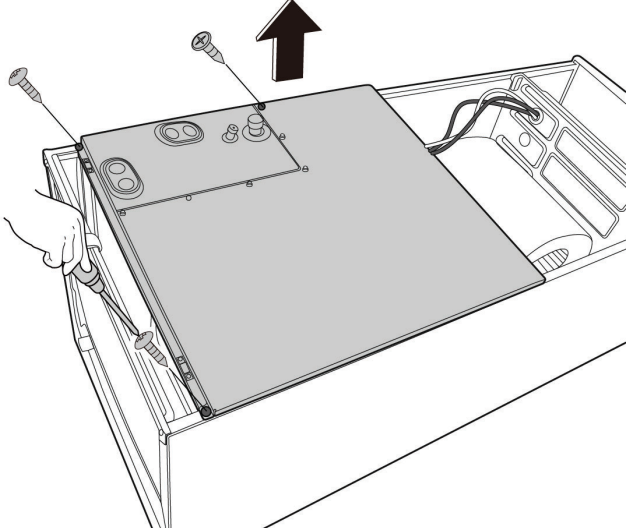
PROCEDURES	ILLUSTRATION
<p>1. Remove the cover plate.</p>	
<p>2. Remove the cover plate assembly screws (3).</p>	

DISASSEMBLY INSTRUCTIONS (CONT.)

Evaporator (Cont.)

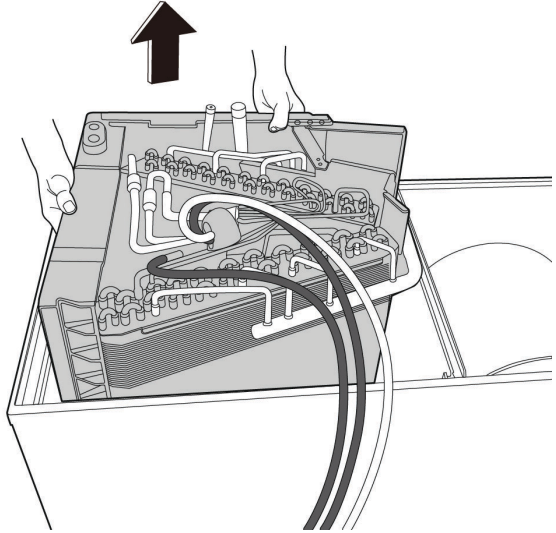
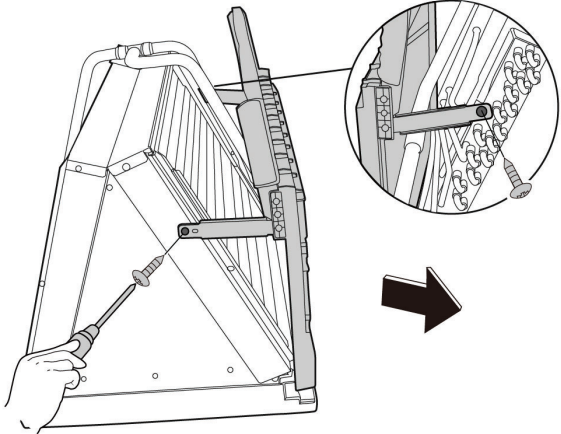
PROCEDURES	ILLUSTRATION
<p>3. Remove the evaporator (with a water collector assembly).</p>	
<p>4. Remove the water collector assembly screws (2). 5. Release the evaporator and water collector assembly.</p>	

APPENDICES

Appendix 1

Table 14 — Temperature Sensor Resistance Value Table for T1, T2, T3, T4 (°C--K)

°C	°F	K OHM	°C	°F	K OHM	°C	°F	K OHM	°C	°F	K OHM
-20	-4	115.266	20	68	12.6431	60	140	2.35774	100	212	0.62973
-19	-2	108.146	21	70	12.0561	61	142	2.27249	101	214	0.61148
-18	0	101.517	22	72	11.5	62	144	2.19073	102	216	0.59386
-17	1	96.3423	23	73	10.9731	63	145	2.11241	103	217	0.57683
-16	3	89.5865	24	75	10.4736	64	147	2.03732	104	219	0.56038
-15	5	84.219	25	77	10	65	149	1.96532	105	221	0.54448
-14	7	79.311	26	79	9.55074	66	151	1.89627	106	223	0.52912
-13	9	74.536	27	81	9.12445	67	153	1.83003	107	225	0.51426
-12	10	70.1698	28	82	8.71983	68	154	1.76647	108	226	0.49989
-11	12	66.0898	29	84	8.33566	69	156	1.70547	109	228	0.486
-10	14	62.2756	30	86	7.97078	70	158	1.64691	110	230	0.47256
-9	16	58.7079	31	88	7.62411	71	160	1.59068	111	232	0.45957
-8	18	56.3694	32	90	7.29464	72	162	1.53668	112	234	0.44699
-7	19	52.2438	33	91	6.98142	73	163	1.48481	113	235	0.43482
-6	21	49.3161	34	93	6.68355	74	165	1.43498	114	237	0.42304
-5	23	46.5725	35	95	6.40021	75	167	1.38703	115	239	0.41164
-4	25	44	36	97	6.13059	76	169	1.34105	116	241	0.4006
-3	27	41.5878	37	99	5.87359	77	171	1.29078	117	243	0.38991
-2	28	39.8239	38	100	5.62961	78	172	1.25423	118	244	0.37956
-1	30	37.1988	39	102	5.39689	79	174	1.2133	119	246	0.36954
0	32	35.2024	40	104	5.17519	80	176	1.17393	120	248	0.35982
1	34	33.3269	41	106	4.96392	81	178	1.13604	121	250	0.35042
2	36	31.5635	42	108	4.76253	82	180	1.09958	122	252	0.3413
3	37	29.9058	43	109	4.5705	83	181	1.06448	123	253	0.33246
4	39	28.3459	44	111	4.38736	84	183	1.03069	124	255	0.3239
5	41	26.8778	45	113	4.21263	85	185	0.99815	125	257	0.31559
6	43	25.4954	46	115	4.04589	86	187	0.96681	126	259	0.30754
7	45	24.1932	47	117	3.88673	87	189	0.93662	127	261	0.29974
8	46	22.5662	48	118	3.73476	88	190	0.90753	128	262	0.29216
9	48	21.8094	49	120	3.58962	89	192	0.8795	129	264	0.28482
10	50	20.7184	50	122	3.45097	90	194	0.85248	130	266	0.2777
11	52	19.6891	51	124	3.31847	91	196	0.82643	131	268	0.27078
12	54	18.7177	52	126	3.19183	92	198	0.80132	132	270	0.26408
13	55	17.8005	53	127	3.07075	93	199	0.77709	133	271	0.25757
14	57	16.9341	54	129	2.95896	94	201	0.75373	134	273	0.25125
15	59	16.1156	55	131	2.84421	95	203	0.73119	135	275	0.24512
16	61	15.3418	56	133	2.73823	96	205	0.70944	136	277	0.23916
17	63	14.6181	57	135	2.63682	97	207	0.68844	137	279	0.23338
18	64	13.918	58	136	2.53973	98	208	0.66818	138	280	0.22776
19	66	13.2631	59	138	2.44677	99	210	0.64862	139	282	0.22231

Appendix 2

Table 15 — Temperature Sensor Resistance Value Table for T5 (TP) (°C--K)

° C	° F	K OHM	° C	° F	K OHM	° C	° F	K OHM	° C	° F	K OHM
-20	-4	542.7	20	68	68.66	60	140	13.59	100	212	3.702
-19	-2	511.9	21	70	65.62	61	142	13.11	101	214	3.595
-18	0	483	22	72	62.73	62	144	12.65	102	216	3.492
-17	1	455.9	23	73	59.98	63	145	12.21	103	217	3.392
-16	3	430.5	24	75	57.37	64	147	11.79	104	219	3.296
-15	5	406.7	25	77	54.89	65	149	11.38	105	221	3.203
-14	7	384.3	26	79	52.53	66	151	10.99	106	223	3.113
-13	9	363.3	27	81	50.28	67	153	10.61	107	225	3.025
-12	10	343.6	28	82	48.14	68	154	10.25	108	226	2.941
-11	12	325.1	29	84	46.11	69	156	9.902	109	228	2.86
-10	14	307.7	30	86	44.17	70	158	9.569	110	230	2.781
-9	16	291.3	31	88	42.33	71	160	9.248	111	232	2.704
-8	18	275.9	32	90	40.57	72	162	8.94	112	234	2.63
-7	19	261.4	33	91	38.89	73	163	8.643	113	235	2.559
-6	21	247.8	34	93	37.3	74	165	8.358	114	237	2.489
-5	23	234.9	35	95	35.78	75	167	8.084	115	239	2.422
-4	25	222.8	36	97	34.32	76	169	7.82	116	241	2.357
-3	27	211.4	37	99	32.94	77	171	7.566	117	243	2.294
-2	28	200.7	38	100	31.62	78	172	7.321	118	244	2.233
-1	30	190.5	39	102	30.36	79	174	7.086	119	246	2.174
0	32	180.9	40	104	29.15	80	176	6.859	120	248	2.117
1	34	171.9	41	106	28	81	178	6.641	121	250	2.061
2	36	163.3	42	108	26.9	82	180	6.43	122	252	2.007
3	37	155.2	43	109	25.86	83	181	6.228	123	253	1.955
4	39	147.6	44	111	24.85	84	183	6.033	124	255	1.905
5	41	140.4	45	113	23.89	85	185	5.844	125	257	1.856
6	43	133.5	46	115	22.89	86	187	5.663	126	259	1.808
7	45	127.1	47	117	22.1	87	189	5.488	127	261	1.762
8	46	121	48	118	21.26	88	190	5.32	128	262	1.717
9	48	115.2	49	120	20.46	89	192	5.157	129	264	1.674
10	50	109.8	50	122	19.69	90	194	5	130	266	1.632
11	52	104.6	51	124	18.96	91	196	4.849			
12	54	99.69	52	126	18.26	92	198	4.703			
13	55	95.05	53	127	17.58	93	199	4.562			
14	57	90.66	54	129	16.94	94	201	4.426			
15	59	86.49	55	131	16.32	95	203	4.294			
16	61	82.54	56	133	15.73	96	205	4.167			
17	63	78.79	57	135	15.16	97	207	4.045			
18	64	75.24	58	136	14.62	98	208	3.927			
19	66	71.86	59	138	14.09	99	210	3.812			