

SUPERSEDES: March 1, 2004

EFFECTIVE: March 2, 2016

Plant ID#: 9300-1057



The PC705-2 is a microprocessor-based PID control designed to regulate the supply water temperature to a heating system by controlling a boiler and the speed of an injection pump. The PC705-2 controls the system supply water temperature based on the outdoor air temperature (outdoor reset). A boiler sensor can be connected in order to prevent corrosion in the boiler due to flue gas condensation. If the PC705-2 is controlling the boiler supply water temperature, the control continuously adjusts the boiler differential in order to optimize the firing cycles of the boiler, prevent large water temperature swings, and increase the efficiency of the system. A wiring harness is provided to be easily connected to the Taco Expandable (-EXP) Controls.

The PC705-2 also includes features such as an automatic reset ratio calculation, Warm Weather Shut Down (WWSD), and a maximum supply water temperature setting.

Control Strategy	pg. 1	Control Adjustments	pg. 9
Variable Speed Injection	pg. 3	Display Operation	pg. 10
Sequence of Operation	pg. 4	Troubleshooting	pg. 11
Installation	pg. 5	Error Messages	pg. 12
Applications	pg. 6	Settings	pg. 9

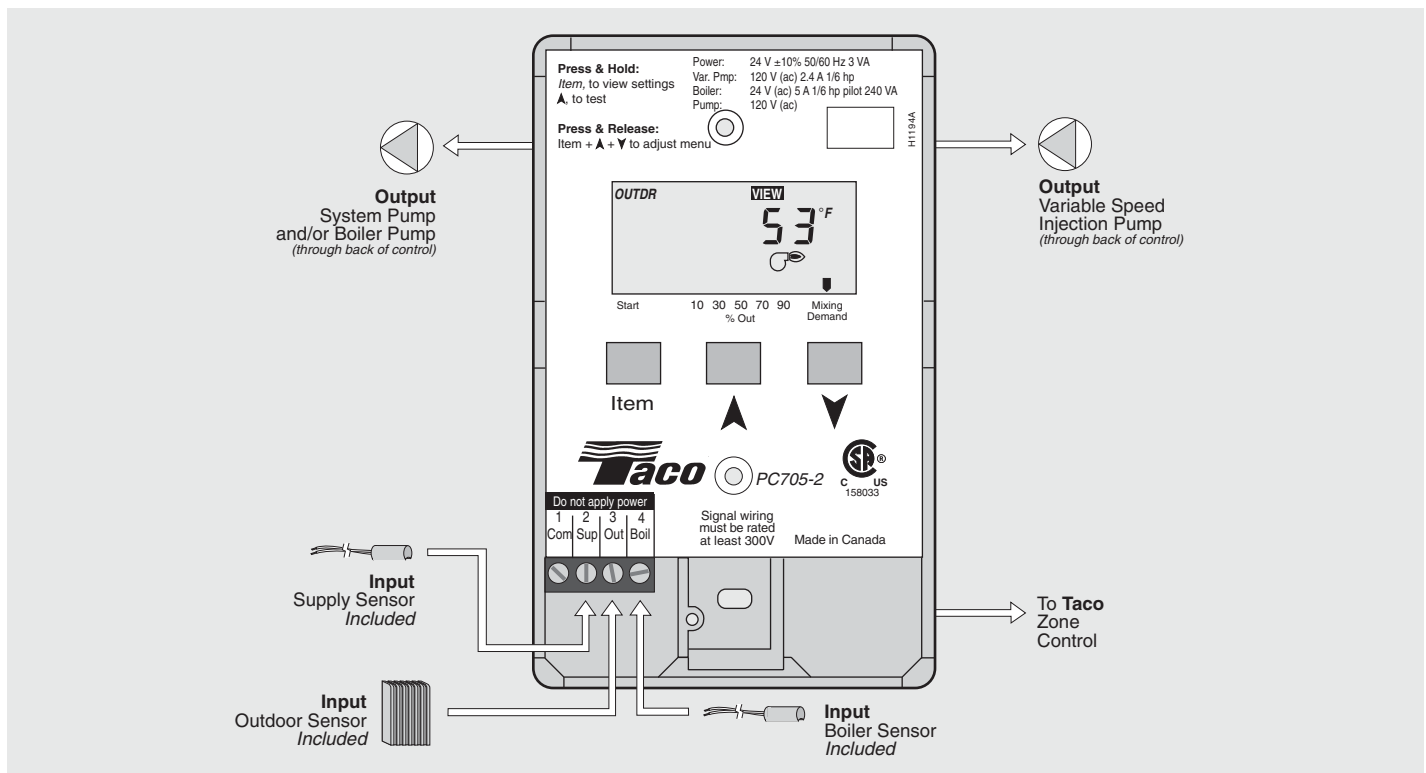

Control Strategy

OUTDOOR RESET

In order to properly control a hot water heating system, the heat supplied to the building must equal the heat lost by the building.

- The heat supplied to a building is proportional to the temperature of the water and the surface area of the heating element. A small surface area such as baseboard radiators requires a higher water temperature than a larger surface area such as radiant floors.
- The heat lost from a building is dependent on the outdoor temperature. As the outdoor temperature drops, the building heat loss increases.

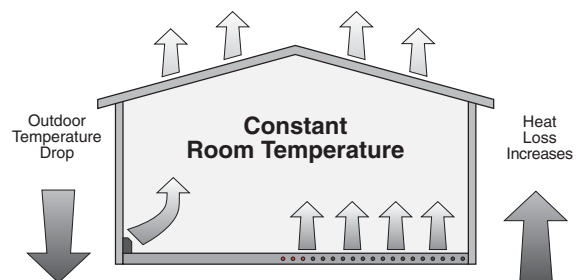

Reset Ratio

Operation of a hot water heating system can generally be improved by modulating the supply water temperature as the outdoor temperature changes. Using this approach, the heat lost from the building is matched by the heat input to the building. The PC705-2 Variable Speed Injection Mixing Control utilizes a reset ratio to set the relationship between outdoor temperature and supply water temperature. The reset ratio determines the amount the supply water temperature is raised for every 1° drop in outdoor air temperature, and it is determined from the starting point and the system design conditions. In order for the control to automatically determine the reset ratio, a starting point and design conditions must be established. These two points are set by the following 4 adjustments:

- Mixing starting temperature
- Outdoor starting temperature
- Mixing design supply water temperature
- Outdoor design temperature

See Settings - Step Four for a complete description of each setting.

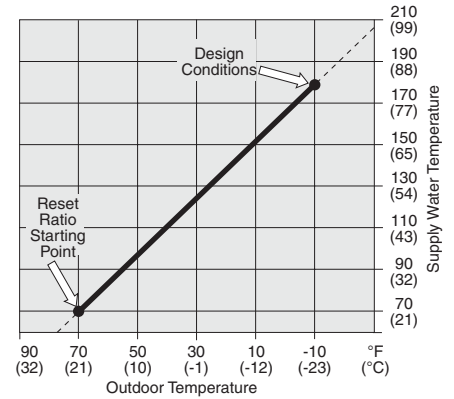

Reset Ratio Starting Point

The first point used to establish the reset ratio calculation is the starting point. It is a combination of an adjustable mixing starting water temperature setting and the outdoor starting temperature setting.

Design Conditions

The second point to establish the reset ratio calculation is the design conditions. This point represents the required water temperature during the coldest day of the year.

Warm Weather Shut Down (WWSD)

When the outdoor air temperature is warmer than the Warm Weather Shut Down setting, no additional heat is required in the building; therefore, the heating system can be shut down. This setting has no effect on the reset ratio calculation.

BOILER OPERATION

The supply water temperature from a boiler can be controlled by cycling the boiler on and off. Modulation of the boiler's operating temperature in hot water heating systems not only provides more comfort but also offers significant energy savings. The cooler the boiler runs, the more efficient it is due to less heat losses up the flue and reduced boiler jacket losses.

Differential

An on / off boiler must be operated with a differential in order to prevent short cycling. When the supply water temperature drops below the bottom rail of the differential, the boiler is turned on. The boiler is then kept on until the supply water temperature rises above the top rail of the differential. If the differential is too wide, there can be large supply water temperature swings; however, if the differential is too narrow, the boiler short cycles and operates inefficiently. This control automatically calculates the boiler differential in order to achieve an appropriate balance between temperature swings and boiler efficiency. This also permits the control to adapt to changing loads and conditions.

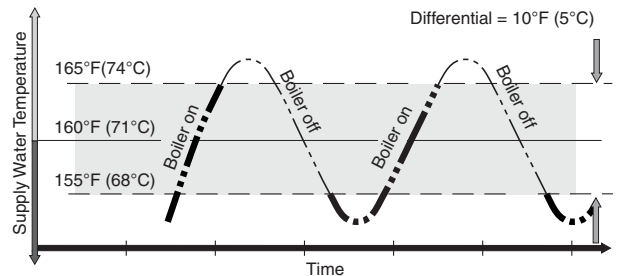

Minimum Boiler Supply

Most boilers require a minimum supply water temperature in order to prevent corrosion from flue gas condensation. The control should therefore only modulate the boiler supply water temperature down to the boiler manufacturer's minimum recommended operating temperature. Some boilers are designed to condense and should be operated at low water temperatures as much as possible for maximum efficiency.

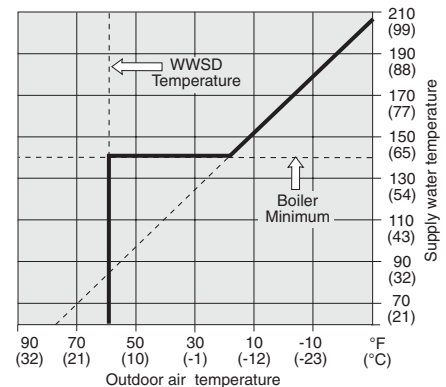

MIXING OPERATION

The full range of water temperatures required through a heating season can be provided with a standard (non-condensing) boiler by incorporating a modulating mixing device into the system. Mixing valves or variable speed injection pumps are commonly used to modulate both the system supply water temperature and the boiler return water temperature. The modulation of water temperatures improves comfort in the building and also protects the boiler from cool return water.

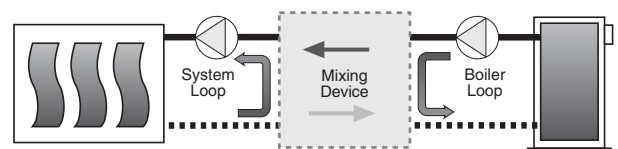

Boiler Protection

Cool water is often returned to the boiler from low temperature radiant floor heating systems or when the heating system is recovering from night setback. This cool boiler return water may cause the boiler to operate at such a low temperature that the flue gases condense. Alternatively, when the boiler surfaces are hot due to previous loads such as domestic hot water generation, the large temperature difference (ΔT) between the boiler and its return water can cause the boiler to become thermally shocked. Proper protection of the boiler under these circumstances requires a modulating mixing device that can temporarily reduce the heating load. This is normally accomplished by closing a valve or reducing the speed of an injection pump.

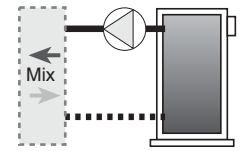

Maximum System Supply

Some systems, such as hydronic radiant floor heating, usually operate at water temperatures that are below the minimum boiler supply temperature. This is due to the large surface area of the floors which radiate a significant amount of heat at low water temperatures. Floor heating systems also have a maximum floor surface temperature limit for occupant health reasons and to protect the materials within the floor. In such systems a modulating mixing device is normally required to limit the supply water temperature.

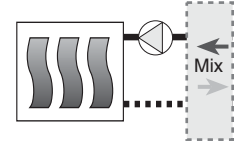

Variable Speed Injection

Variable Speed Injection Pump

The PC705-2 uses a pump to inject hot water from the boiler loop into the cool system return water. This pump is operated by the PC705-2 at different speeds in order to inject hot boiler water at different rates into the cool system return water. For residential and small commercial systems Taco wet rotor circulators are suitable for use as variable speed injection pumps.

Boiler Loop Pump and a Boiler Supply Sensor

The use of a boiler loop pump and boiler supply sensor allows the PC705-2 to regulate the boiler supply water temperature as well as the system supply water temperature. If the system supply water temperature approaches a maximum setting, the control can back off the speed of the injection pump in order to protect the system. The same also occurs when the boiler supply water temperature approaches a minimum boiler setting.

The rate of response to sudden temperature changes by the variable speed injection system can be typically 2 to 4 times faster than by a tempering valve or mixing valve. This faster response provides greater protection for both the system and the boiler.

PIPING OF VARIABLE SPEED INJECTION SYSTEMS

Since mixing by a variable speed injection pump is a relatively new concept, there are a few piping details which should be considered.

When the injection pump is turned off, there must be no heat transfer from the boiler loop to the system loop. In order to avoid this unwanted heat transfer, standard primary-secondary piping techniques are used as shown in Figure 1. This piping arrangement requires that the injection piping be at least one pipe diameter smaller than the piping of the boiler and system loops (Note 1) in order to prevent ghost flow when the variable speed injection pump is off and either the boiler pump or system pump is on. Also, there must be at least 6 pipe diameters of straight pipe on either side of the tees (Note 2) in order to prevent the momentum of water in the boiler and system loops from pushing flow through the injection loop. Finally, there should be a minimum 1 foot drop to create a thermal trap (Note 3) in order to prevent convective heat transfer through the injection loop.

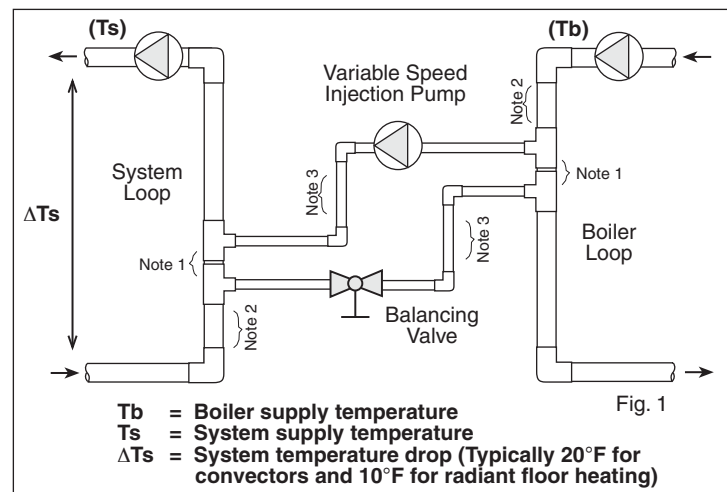

Design Procedure

- 1) Determine the design operating temperatures of the heating system loop and boiler. (T_s and T_b from figure 1.)
- 2) Determine the flow rate and design temperature drop (ΔT_s) in the system loop when all zones are turned on. If one of these variables is unknown, use Equation 1 or 2 to calculate the other variable.
- 3) Compute $T_b - T_s$. Look up the flow ratios on Figure 2.
- 4) The design injection flow rate for direct injection is calculated from Equation 3. If the injection flow rate is greater than 45 US GPM, it may be necessary to use a 4-way mixing valve instead of a variable speed injection system.
- 5) Decide whether or not to include a balancing valve in the injection piping. A balancing valve allows adjustment when the injection pump is larger than needed. A balancing valve also provides the possibility of manual operation of the heating system by turning the injection pump fully on and adjusting the balancing valve to obtain the desired system supply water temperature.
- 6) The injection piping size and model of pump to install can now be looked up in Figure 3. Don't oversize the injection system. If the heating system is not able to get enough heat, the boiler's operating temperature can be increased. This may be done automatically by the PC705-2 when the boiler sensor is used.

Equation 1 System Flow Rate (US GPM) = $\frac{\text{Design Heating Load (Btu/hr)}}{500 \times \Delta Ts (^{\circ}F)}$

Equation 2 $\Delta Ts (^{\circ}F) = \frac{\text{Design Heating Load (Btu/hr)}}{500 \times \text{System Flow Rate (US GPM)}}$

Equation 3 Design Injection Flow Rate (US GPM) = System Flow Rate (US GPM) x Flow Ratio

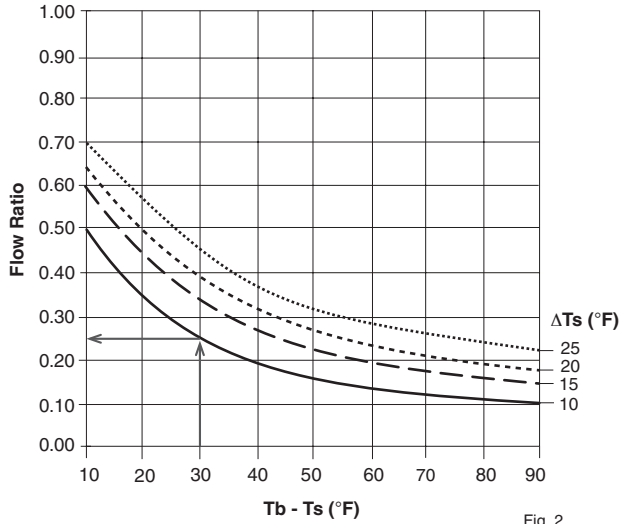

Design Injection Flow Rate (US GPM)		Turns open of the Balancing Valve (%)	Nominal Pipe Diameter (inches)	TACO Pump
Without Balancing Valve	With Balancing Valve			
—	1.5	20	0.5	Taco 007
4.0	3.0	100	0.5	Taco 007
4.5	3.0	50	0.5	Taco 007
7.3	6.0	100	0.75	Taco 007
9.5	7.4	100	0.75	Taco 007
10.0	8.3	100	0.75	Taco 007
14.0	12.0	100	1	Taco 007
23.0	20.0	100	1.25	Taco 0010
35.0	31.0	100	1.5	Taco 0012
41.0	38.5	100	2	Taco 0012
45.0	41.5	100	2	Taco 0012

This table assumes there are 5 feet of pipe, 4 elbows, and 4 branch tees of the listed diameter.

Fig. 3

Sequence of Operation

POWERING UP THE CONTROL

After the PC705-2 is powered up, all the LCD segments are tuned on for 2 seconds, followed by a software version number. The control then displays the outdoor temperature.

MIXING DEMAND

The PC705-2 obtains a mixing demand through the Taco Zone Control when a zone calls for heat. When the PC705-2 receives a mixing demand, the Mixing Demand pointer is displayed in the LCD.

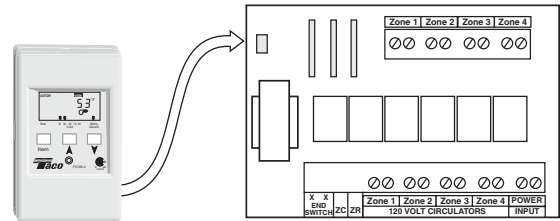

MIXING OPERATION

The PC705-2 calculates the required supply water temperature based on the outdoor temperature. The supply water temperature is then controlled by varying the speed of an injection pump to maintain the target supply temperature. As the heating load increases, the PC705-2 speeds up the injection pump and as the load decreases, the PC705-2 slows down the injection pump. The bar graph in the bottom of the LCD indicates the speed of the variable speed injection.

Warm Weather Shut Down (WWSD)

When the outdoor temperature is warmer than the WWSD setting, the PC705-2 turns off the boiler and the variable speed injection pump. The PC705-2 has a freeze protection feature that does not allow the supply water temperature to drop below 35°F (2°C) as long as there is a mixing demand signal.

Maximum System Supply Temperature

The PC705-2 has a Maximum Supply setting that can be used to set a maximum system supply water temperature. If the supply water temperature approaches the Maximum Supply setting, the control reduces the speed of the injection pump.

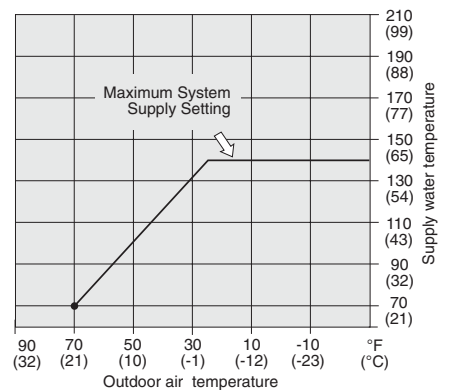

SYSTEM PUMP OPERATION

The PC705-2 has an internal system pump contact. This contact turns on when the PC705-2 has a mixing demand and is not in a WWSD. The system pump as well as the boiler pump may be controlled by this relay. By providing proper flow in the boiler loop, the boiler temperature can be accurately controlled based on the mixing load.

BOILER OPERATION

Boiler Sensor Installed

While the PC705-2 has a mixing demand, the boiler supply water temperature is controlled by turning the boiler on and off. The PC705-2 calculates the required boiler supply water temperature based on the load on the mixing system. In order to allow the PC 705-2 to control the boiler, the Mode switch on the Zone Control must be set to Reset.

The boiler operates around a differential that is automatically controlled by the PC705-2. The control includes a minimum on and off time for the heat source, in order to minimize short cycling. The automatic boiler differential increases system efficiency by adjusting to changing loads.

Boiler Sensor Not Installed

When the PC705-2 has a mixing demand, the boiler turns on and operates off the boiler operating aquastat. The Mode switch on the Zone Control must be set to Normal in this application. To improve boiler operation efficiency, the boiler design temperature should be selected as low as possible, and the injection pump, must then be sized accordingly.

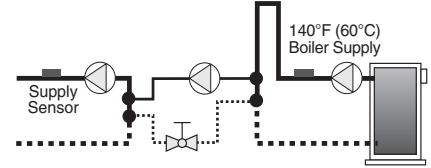
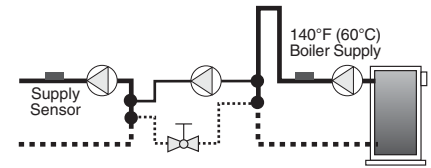

Boiler Protection

When the boiler sensor is installed on the supply side of the boiler the PC705-2 can protect the boiler against flue gas condensation. When this sensor is installed, the PC705-2 ensures a boiler supply water temperature of at least the Boiler Minimum setting. If the water temperature is less than the Boiler Minimum setting, the PC705-2 turns on the MIN segment in the LCD and decreases the speed of the injection pump.

Installation

CAUTION

Improper installation and operation of this control could result in damage to the equipment and possibly even personal injury. It is your responsibility to ensure that this control is safely installed according to all applicable codes and standards. This electronic control is not intended for use as a primary limit control. Other controls that are intended and certified as safety limits must be placed into the control circuit.

STEP ONE

Check the contents of this package. If any of the contents listed are missing or damaged, please contact your sales representative for assistance.

Type PC705-2 includes:

- PC705-2 Variable Speed Mixing Control
- One Outdoor Sensor
- Two Strap on Sensors
- Instruction Sheet

Replacement sensors are available from Taco, Inc.

Strap on Sensor – 9300-2044RP

Outdoor Sensor – 9300-2052RP

Note: Carefully read the details of the Sequence of Operation sections in all applicable brochures to ensure that you have chosen the proper control for your application.

STEP TWO

Installing the Control

- Grasp the front cover by the fingertip grips on the top and bottom of the enclosure and pull the front cover off. Remove the wiring cover screw.
- The enclosure is mounted onto a 2" x 4" electrical box near the Taco Zone Control. Ensure that the depth of the electrical box is enough to house all of the wiring that will be in it.
- The mounting holes in the enclosure accept #6 screws.
- Wiring to the control enters the wiring chamber through the back or bottom of the enclosure.
- To reassemble the enclosure, first replace the wiring chamber cover and then push the front cover onto the enclosure until it snaps into place.

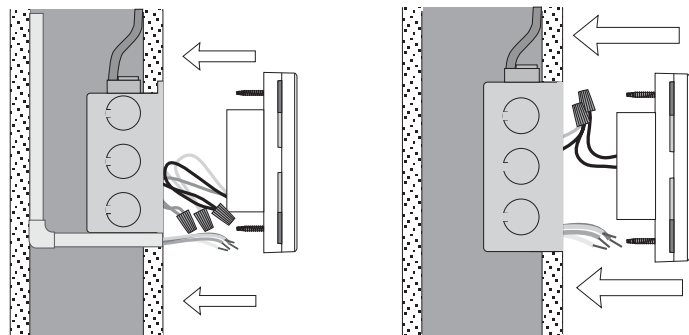

The variable speed injection pump and system pump wiring terminates in the electrical box. All other electrical wiring terminates in the two wiring chambers on the control. The wiring is roughed-in to the electrical box prior to installation of the control.

Reference Applications PC 705-2

Drawing 1/705-2: Radiant Floor Heating

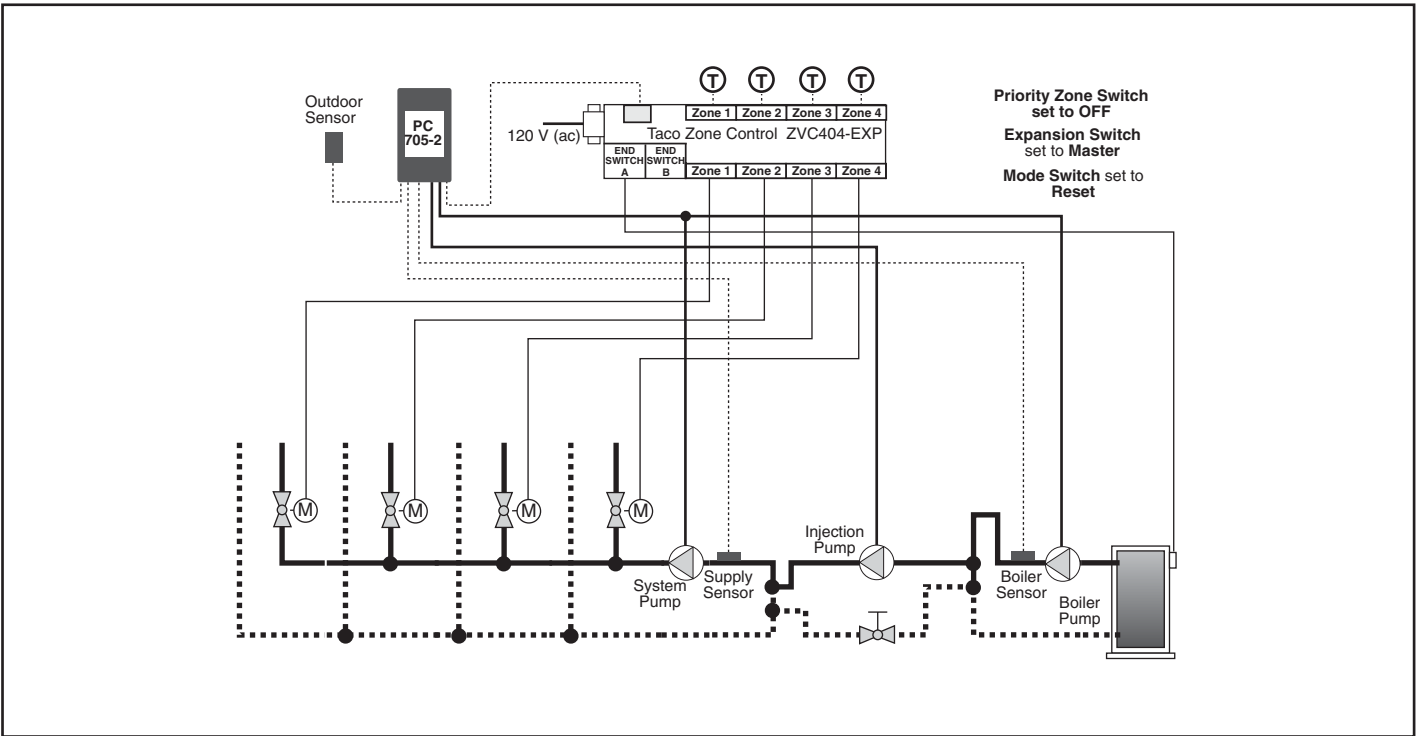

Drawing 2/705-2: Radiant Floor Heating with DHW generation

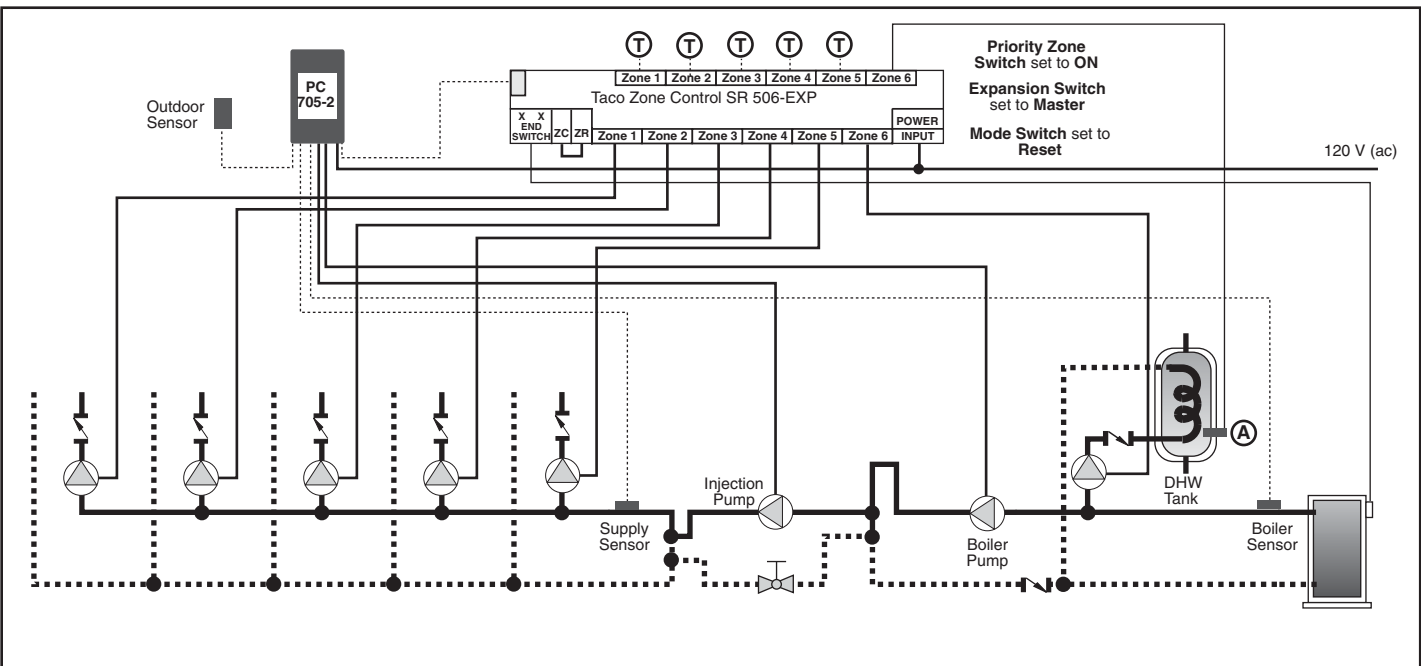

Drawing 3/705-2: Radiant Floor Heating, High Temperature heating with DHW generation

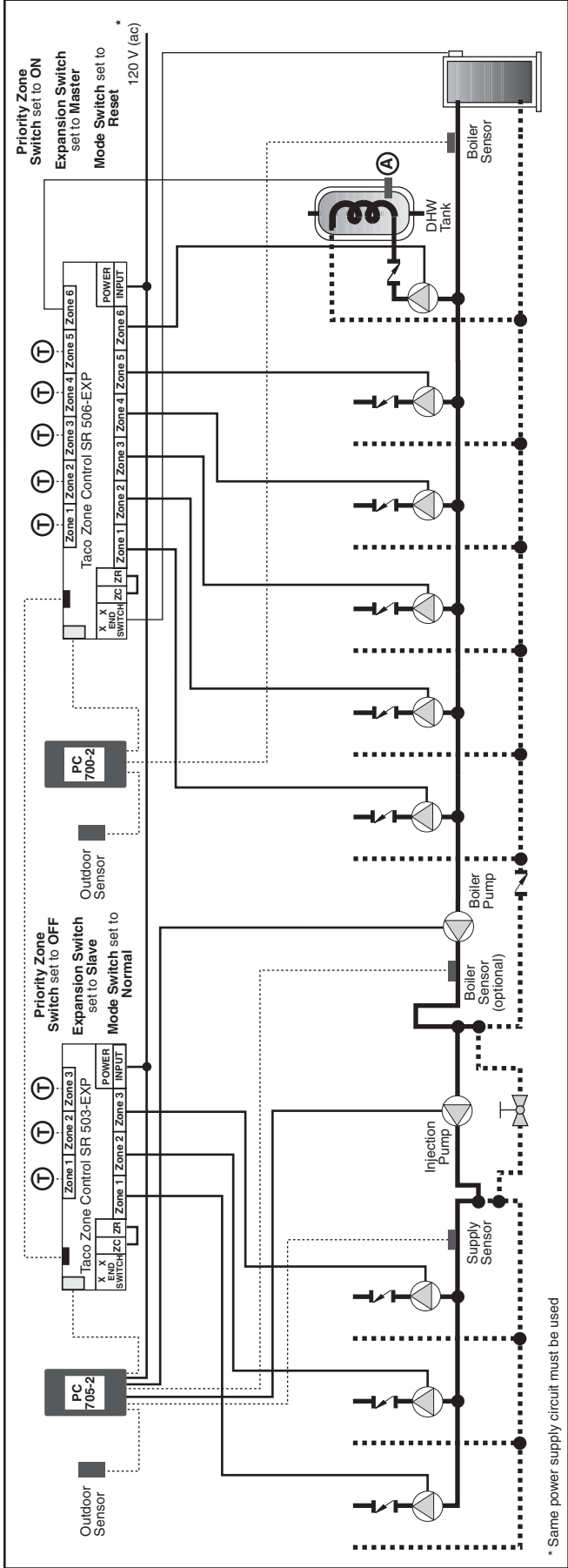

Drawing 4/705-2: Radiant Floor Heating, High Temperature heating with 2 boilers and DHW generation

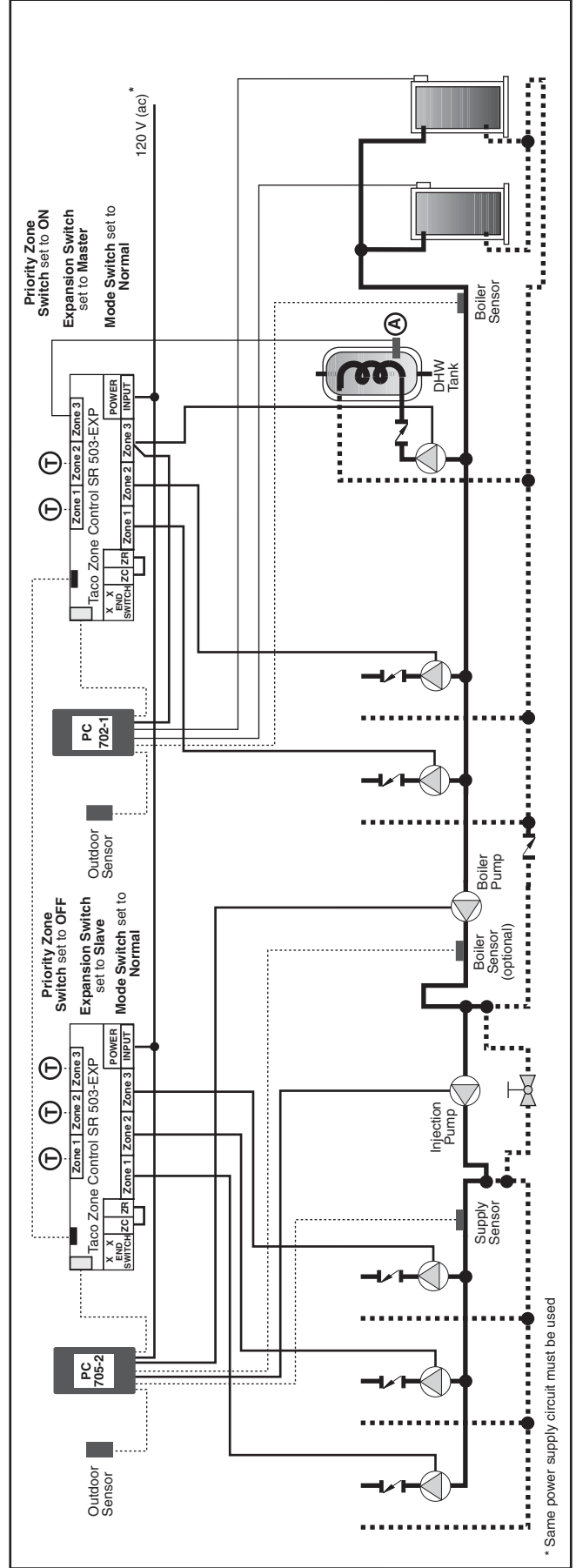

Installing the Outdoor Sensor

Note The temperature sensor (thermistor) is built into the enclosure.

- Take the sensor cover off by sliding it upward relative to the sensor base.
- Use one round or pan head screw to attach the base of the sensor to the wall.
- The sensor is wall mounted and the wiring enters through the bottom of the enclosure. The hole for the cable entry must face downward in order to prevent water from entering and filling the enclosure.
- The sensor should be mounted on a wall which best represents the heat load on the building (i.e. a northern wall for most buildings and a southern facing wall for buildings with large south facing glass areas). The sensor should not be installed near heat sources such as ventilation or window openings.
- The sensor should be installed at an elevation above the ground that will prevent accidental damage or tampering.
- Install the Outdoor Sensor and run the wiring back to the control mounting location.

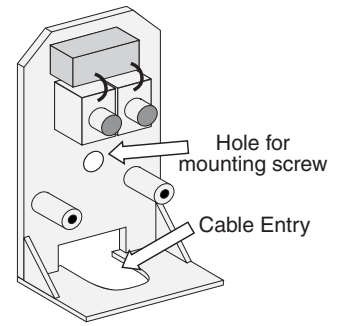

Installing the Supply Sensor and Boiler Sensor

Note These sensors are designed to mount on a pipe or in a temperature immersion well.

- The sensors can be strapped directly to the pipe using the cable tie provided. Insulation should be placed around the sensors to reduce the effect of air currents on the sensor measurement.
- The Boiler Sensor and the Supply Sensor should be placed downstream of a pump or after an elbow or similar fitting. This is especially important if large diameter pipes are used because the thermal stratification within the pipe can result in erroneous sensor readings. Proper sensor location requires that the fluid is thoroughly mixed within the pipe before it reaches the sensor.

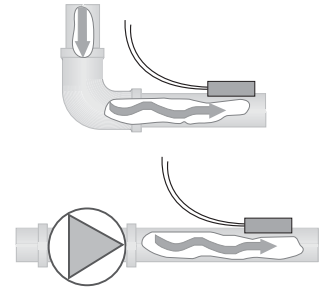
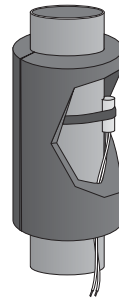

STEP THREE

Wiring to the Zone Control

Connect the PC705-2 cable to the Add-On interface on the Taco Zone Control. Ensure the Mode switch on the Zone Control is set to Reset if boiler control is desired, or Normal if boiler enable is desired (refer to the Boiler Operation section).

Wiring the Sensors

Do not apply power to these terminals as this will damage the control.

Outdoor Sensor

Connect the two wires from the Outdoor Sensor directly to the Com — Out (1 and 3) terminals. The Outdoor Sensor measures the outdoor air temperature.

Supply Sensor

Connect the two wires from the Supply Sensor directly to the Com — Sup (1 and 2) terminals. The Supply Sensor measures the water temperature supplied to the system.

Boiler Sensor (Optional)

Connect the two wires from the Boiler Sensor directly to the Com— Boil (1 and 4) terminals. The Boiler Sensor measures the boiler supply water temperature.

Variable Speed Injection Pump

The PC705-2 can vary the speed of a permanent capacitor impedance protected or equivalent pump motor that has a locked rotor current of less than 2.4 A. The Taco "00" family of wet rotor circulators are suitable for the PC705-2. The variable speed output must not be used on pumps which have a centrifugal switch. The PC705-2 has an internal overload protection fuse which is rated at 2.5 A 240 V (ac). This fuse is not field replaceable. Contact your sales representative for details on the return and repair procedures if this fuse is blown.

Connect the black wire from the back of the control to the live (L) side of the 120 V (ac) power source. Connect one of the wires from the variable speed injection pump to the blue wire from the back of the control. The other wire on the variable speed injection pump must be connected to the neutral (N) side of the 120 V (ac) power supply. Connect the green wire on the back of the control to ground.

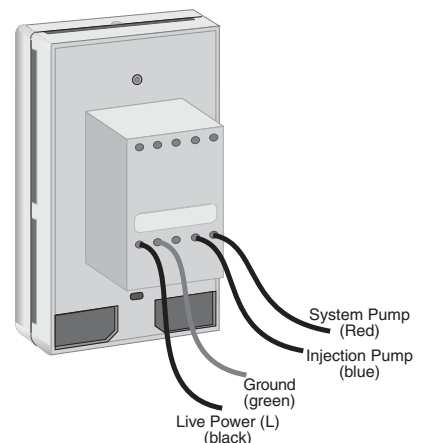
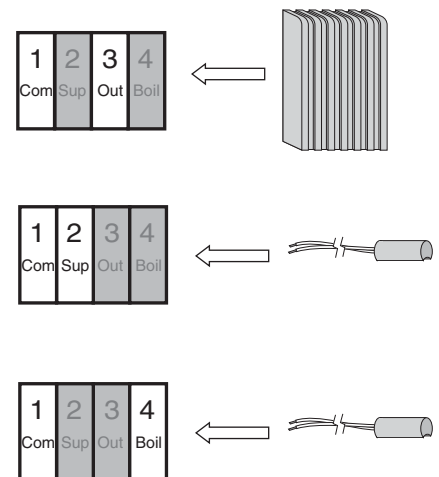

System Pump

The PC705-2 has an internal relay rated for 5 Amps to operate a system pump. Connect the black wire from the back of the control to the live (L) side of the 120 V (ac) power source. Connect one of the wires from the system pump to the red wire from the back of the control. The other wire on the system pump must be connected to the neutral (N) side of the 120 V (ac) power supply. Connect the green wire on the back of the control to ground.

Settings

Before adjusting the dial settings, read through the sequence of operation to ensure that you understand how the control operates.

STEP FOUR

Mixing Starting Temperature (MIX Start)

The MIX Start setting is the starting supply water temperature of the reset ratio, and can be adjusted from 35 to 150°F (2 to 66°C). This setting is typically set to the desired building temperature. In applications where fan coils are used, the MIX Start may need to be set higher to prevent cold drafts during mild outdoor conditions. If the building feels cool during mild outdoor conditions, the MIX Start setting should be increased.

Outdoor Starting Temperature (OUTDR Start)

The OUTDR Start setting is the outdoor temperature at which the mixing starting temperature is supplied. The adjustment range is from 35 to 85 °F (2 to 29°C). This setting is typically set to the desired building temperature.

Mixing Design Temperature (MIX DSGN)

The MIX DSGN setting is the water temperature required to satisfy the building heat loss during the coldest outdoor temperature. This adjustment is typically dependent on the type of heating terminal used. The following are suggested settings for different terminal units:

- | | | | |
|---------------------------|---------------------------|------------------------------|---------------------------|
| • Inslab Radiant | 100 to 140°F (38 to 60°C) | • Radiant Baseboard | 130 to 160°F (54 to 71°C) |
| • Staple-up Radiant | 130 to 160°F (54 to 71°C) | • Convective Baseboard | 160 to 190°F (71 to 88°C) |
| • Radiators | 140 to 160°F (60 to 71°C) | • Fan Coil | 180 to 200°F (82 to 93°C) |

Outdoor Design Temperature (OUTDR DSGN)

The OUTDR DSGN setting is the outdoor temperature used in the heat loss calculation. It is set to the typical coldest outdoor temperature.

Mixing Maximum Temperature (MIX MAX)

The PC705-2 prevents the mixed supply water temperature from rising above the MIX MAX setting. The adjustment range is from 80 to 225°F (27 to 107°C). The MIX MAX should be set to the maximum temperature allowed in the system loop. There are many factors which may limit the allowable supply water temperature in a radiant floor heating slab; a few are provided below.

- Nowhere in the concrete should the temperature be maintained above 170°F (77°C).
- The surface temperature of a radiant floor heating slab should normally not exceed 85°F (29°C). The slab surface temperature is affected by the slab thermal resistance, the heating load, and the supply water temperature to the slab.

Boiler Minimum Supply Temperature (BOIL MIN)

Most boilers require a minimum operating temperature to prevent corrosion from flue gas condensation. The minimum boiler setting should be programmed to the lowest supply water temperature at which the boiler can operate without causing the boiler flue gases to condense. Consult the boiler manufacturer for recommended minimum boiler supply temperatures. Some typical settings are as follows:

- | | | | |
|--------------------------------|---------------------------|---------------------------|-----|
| • Steel fire tube boiler | 140 to 160°F (60 to 71°C) | • Condensing boiler | Off |
| • Cast iron boiler | 135 to 160°F (57 to 71°C) | • Electric boiler | Off |
| • Copper tube boiler | 125 to 150°F (52 to 66°C) | | |

Note: This setting is only available if a boiler sensor is connected to the PC705-2.

Warm Weather Shut Down (WWSD)

The WWSD can be adjusted from 35 to 100°F (2 to 38°C). The system will be shut down when the outdoor temperature is warmer than this setting.

Control Adjustments

Mixing Start: _____	Mixing Maximum: _____
Outdoor Start: _____	Boiler Minimum: _____
Mixing Design: _____	WWSD: _____
Outdoor Design: _____	

Display Operation

POWER UP

On power up, the control displays all segments for 2 seconds, followed by the control version number.

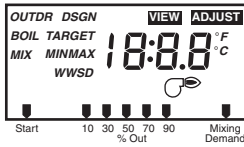

The control then automatically goes to operating mode, and displays the outdoor temperature.

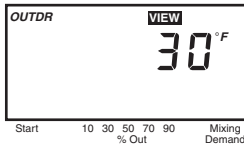

VIEW MENU

Outdoor Temperature
The outdoor temperature is displayed when the OUTDR element is turned on.

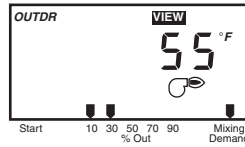

Mixing Temperature
Press and release the Item button until the MIX element is displayed.

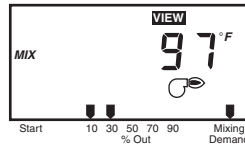

Mixing Target Temperature
Press and release the Item button until the MIX TARGET elements are displayed.

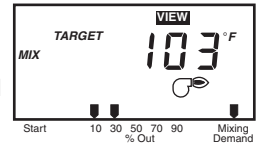

Boiler Temperature
Press and release the Item button until the BOIL element is displayed.

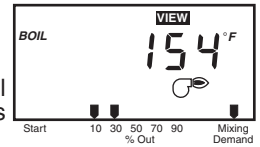

To view all control settings, the Item button may be pressed and held while in the View Menu. The control will then scroll through all the adjustable items.

ADJUST MENU

To enter the adjustment mode, Press and Hold simultaneously, the Item, ▲ and ▼ Buttons. The ADJUST element will turn on.

MIX Start
Use the ▲ and ▼ buttons to set the desired mixing starting temperature.

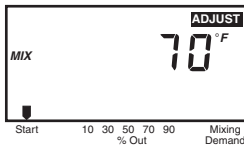

OUTDR DSGN
Press and release the Item button. Use the ▲ and ▼ buttons to set the outdoor design temperature.

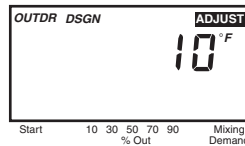

WWSD
Press and release the Item button. Use the ▲ and ▼ buttons to set the desired WWSD temperature.

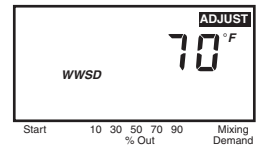

OUTDR Start
Press and release the Item button. Use the ▲ and ▼ buttons to set the desired outdoor starting temperature.

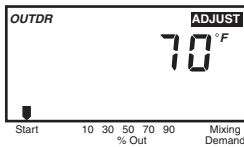

MIX MAX
Press and release the Item button. Use the ▲ and ▼ buttons to set the mixing maximum temperature.

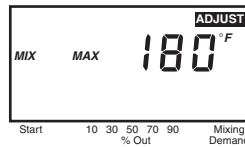

Units
Press and release the Item button. Use the ▲ and ▼ buttons to select between °F and °C.

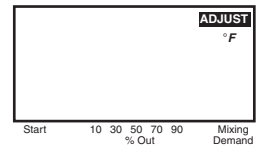

MIX DSGN
Press and release the Item button. Use the ▲ and ▼ buttons to set the mixing design temperature.

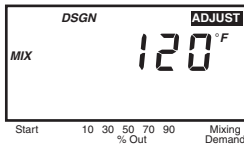

BOIL MIN
Press and release the Item button. Use the ▲ and ▼ buttons to set the boiler minimum temperature.

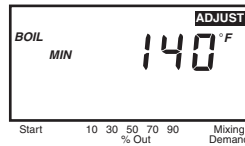

The control automatically goes back to viewing when the buttons are left alone for 20 seconds

All settings will be saved even during power down of the control

Troubleshooting

STEP FIVE

The main control functions on the PC705-2 can be tested by pressing and holding the UP button. While the UP button is pressed, the boiler and the system pump are turned on, and the variable speed injection pump is turned to 100% of its output speed. Once the UP button is released, the control returns to normal operation.

STEP SIX

As in any troubleshooting procedure, it is important to isolate a problem as much as possible before proceeding. The Error Messages greatly simplify troubleshooting of the PC705-2. When the control displays an error message, identify the fault from the look-up table on page 12 and follow standard testing procedures to confirm the problem. If you suspect a wiring fault, return to step three and carefully check all external wiring and wiring connections.

Sensor and Internal Faults

- If an outdoor sensor fault occurs, the PC705-2 will assume a fixed outdoor temperature of 32°F (0°C) and will target the appropriate supply water temperature. An error message is displayed.
- If a supply sensor fault occurs, and a boiler sensor is installed, the PC705-2 operates the variable speed at an output of 15% and displays an error message. If a supply sensor fault occurs, and a boiler sensor is not installed, the PC705-2 operates the variable speed at an output of 30% and displays an error message.
- If a boiler sensor fault occurs, the PC705-2 operates the boiler as if the sensor was not installed and displays an error message. If the sensor was deliberately removed, remove power from the control to clear the error message.
- If an EEPROM fault occurs, the PC705-2 stops operation until all the settings are verified. An error message is displayed.

Adjustment of Settings

- If the outdoor temperature is cold and the rooms are cold, increase the MIX DSGN setting by 5°F (3°C) per day.
- If the outdoor temperature is near the WWSD temperature and the rooms are cold, increase the MIX Start setting.

Testing the Sensors

A good quality test meter capable of measuring up to 5,000 kΩ (1 kΩ = 1000 Ω) is required to measure the sensor resistance. In addition to this, the actual temperature must be measured with either a good quality digital thermometer, or if a thermometer is not available, a second sensor can be placed alongside the one to be tested and the readings compared.

First measure the temperature using the thermometer and then measure the resistance of the sensor at the control. The wires from the sensor must not be connected to the control while the test is performed. Using the chart below, estimate the temperature measured by the sensor. The sensor and thermometer readings should be close. If the test meter reads a very high resistance, there may be a broken wire, a poor wiring connection or a defective sensor. If the resistance is very low, the wiring may be shorted, there may be moisture in the sensor or the sensor may be defective. To test for a defective sensor, measure the resistance directly at the sensor location.

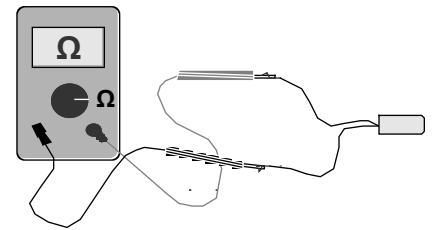

Do not apply voltage to a sensor at any time as damage to the sensor may result.

Temperature		Resistance	Temperature		Resistance	Temperature		Resistance	Temperature		Resistance
°F	°C	Ω	°F	°C	Ω	°F	°C	Ω	°F	°C	Ω
-30	-34	234,196	30	-1	34,558	90	32	7,334	150	66	2,045
-20	-29	165,180	40	4	26,099	100	38	5,828	160	71	1,689
-10	-23	118,018	50	10	19,900	110	43	4,665	170	77	1,403
0	-18	85,362	60	16	15,311	120	49	3,760	180	82	1,172
10	-12	62,465	70	21	11,883	130	54	3,050	190	88	983
20	-7	46,218	80	27	9,299	140	60	2,490	200	93	829

STEP SEVEN

- Install the wiring cover over the wiring chamber and secure it with the screw provided.
- Place the front cover on the control and snap it into place.
- It is important to explain the operation of this control within the system to the end user, and to anyone else who may be operating the system.

Error Messages

Whenever a fault is detected, an error message will be displayed to indicate the location of the problem.

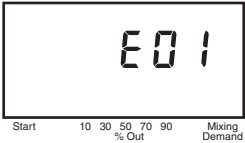
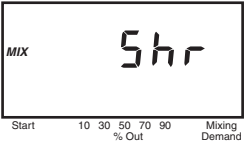
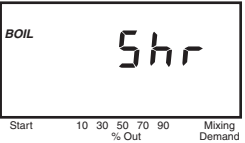
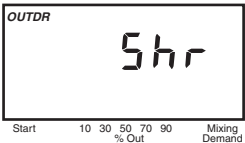
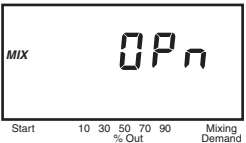
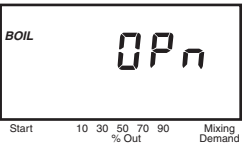
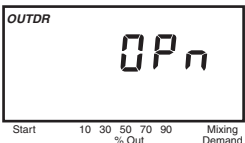
EEPROM Read Error 	Mixing Supply Sensor Short Circuit 	Boiler Sensor Short Circuit 
Outdoor Sensor Short Circuit 	Mixing Supply Sensor Open Circuit 	Boiler Sensor Open Circuit 
Outdoor Sensor Open Circuit 	Refer to the troubleshooting section for operation details.	

Technical Data

PC705-2 Variable Speed Injection Mixing Control

Control	— Microprocessor PID control; This is not a safety (limit) control.
Packaged weight	— 1.5 lb. (670 g), Enclosure D, Taco green PVC plastic
Dimensions	— 4-3/4" H x 2-7/8" W x 1-7/8" D (120 x 74 x 48 mm)
Approvals	— CSA C US, meets ICES & FCC regulations for EMI/RFI.
Ambient conditions	— Indoor use only, 32 to 104°F (0 to 40°C), < 90% RH non-condensing.
Power supply	— 24 V (ac) ±10% 50/60 Hz 3 VA
Variable Pump	— 120 V 50/60 Hz 2.4 A 1/6 hp
Pump Relay	— 120 V (ac) 5 A, 1/3 hp, pilot duty 240 VA
Boiler Relay	— 24 V (ac) 5 A 1/6 hp, pilot duty 240 VA
Sensors included:	— NTC thermistor, 10 kW @77°F (25°C ±0.2°C) β=3892 Outdoor Sensor M 2036 and 2 of Universal Sensor 071

		Factory
MIX Start	— 35 to 150°F (2 to 66°C)	70°F (21°C)
OUTDR Start	— 35 to 85°F (2 to 29°C)	70°F (21°C)
MIX DSGN	— 70 to 220°F (21 to 104°C)	120°F (49°C)
OUTDR DSGN	— -60 to 32°F (-51 to 0°C)	10°F (-12°C)
MIX MAX	— 80 to 225°F (27 to 107°C)	180°F (82°C)
BOIL MIN	— OFF, 80 to 180°F (OFF, 27 to 82°C)	140°F (60°C)
WWSD	— 35 to 100°F, OFF (2 to 38°C, OFF)	70°F (21°C)
Units	— °F, °C	°F

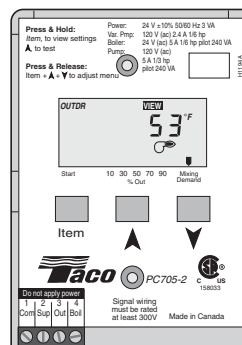

The installer must ensure that this control and its wiring are isolated and/or shielded from strong sources of electromagnetic noise. Conversely, this Class B digital apparatus complies with Part 15 of the FCC Rules and meets all requirements of the Canadian Interference-Causing Equipment Regulations. However, if this control does cause harmful interference to radio or television reception, which can be determined by turning the control off and on, the user is encouraged to try to correct the interference by reorienting or relocating the receiving antenna, relocating the receiver with respect to this control, and/or connecting the control to a different circuit from that to which the receiver is connected.

Taco Comfort Solutions™ A Taco Group Company

Taco, Inc., 1160 Cranston Street, Cranston, RI 02920 | Tel: (401) 942-8000 | FAX: (401) 942-2360

Taco (Canada), Ltd., 8450 Lawson Road, Suite #3, Milton, Ontario L9T 0J8 | Tel: (905) 564-9422 | FAX: (905) 564-9436

Visit our web site: www.TacoComfort.com | Printed in USA | ©2015 Taco, Inc.

