

CVPMA

Evaporator Coil with Vertex™ Technology Multipoise – Cooling and Heating

To be Used with Outdoor HP Piston Heating Metering Device Only*

*Refer to AHRI Directory for Approved Rated Combinations.

Product Data

NOTE: * CVPMA V-Coils can only operate with OD Heat Pump installations that have a Piston Heating Metering device. Use of the V-Coil for OD HP installations that do not have a Piston Metering Device are not an approved installation.

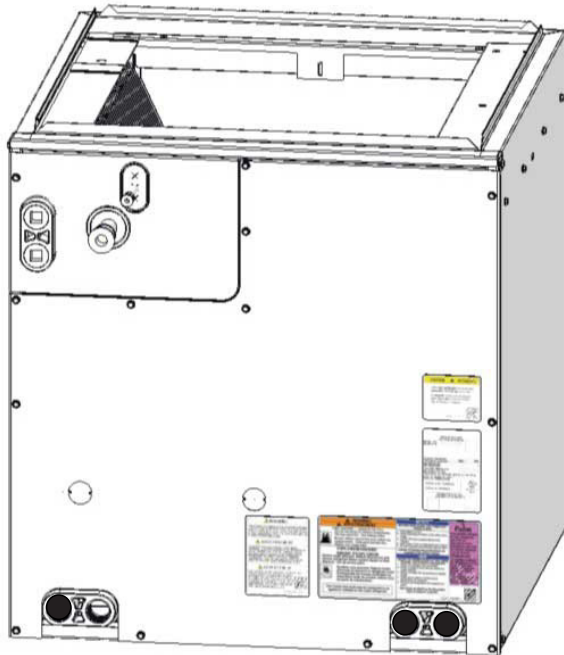

Fig. 1 – Typical Coil

A221165B



This evaporator coil incorporates proven standards for reliable system operation and performance throughout the life of this product. These quality coils, manufactured and installed as part of a total comfort system, provide AHRI-rated performance ratings and are additionally listed with UL and c-UL.

Available for use in Puron® R-410A refrigerant only, it is a cased V-coil that is housed in a durable, 24-gauge, pre-painted taupe metallic cabinet. The fully insulated cabinet (foil faced with R-2.1 insulation) provides for quiet efficient operation of the evaporator coil.

DESIGN FEATURES

- Designed with performance in mind, this new evaporator coil offers lower pressure drops to enhance system performance and airflow characteristics.
- All coils have refrigerant-specific, factory-installed TXVs. All models are factory pre-set to approximately 10° of superheat at the suction service valve.
- The corrosion-resistant drain pan is designed of a “Polybutylene terephthalate” material (PBT) that offers unsurpassed pan strength. It is engineered with proper slope to help ensure water drainage, improved moisture removal, and home comfort.
- The drain pan is supplied with three water-tight drain plugs to prevent leakage from unused drain connections.
- Provided with industry proven sweat connections for leak-free operation to maintain system reliability. The location of the lineset connections allows for removal of the access door for easy cleaning/servicing of the coils, as well as easy access to the TXV. All models come from the factory with enough length of straight tube—once the pipe swages are cut off—to accommodate braze-less compression fittings.
- Meets or exceeds burst pressure of 1900 psi, which is at least three times the maximum operating pressure it would see in actual cooling or heating applications.
- This cased coil comes with factory-installed UV knockouts for quick and easy installation of UV lights.
- Comes with a “no delta plate” for easy, quick access to both sides of the coil for service and cleaning. Also, after the door is removed and refrigerant lines disconnected, the coil is removable from the front of the unit without the use of any tools.

LIMITED WARRANTY

- Default 5-year parts limited warranty:
 - 10-year parts limited warranty with timely registration*.Equipment must be registered within 90 days of original installation, except in jurisdictions where warranty benefits cannot be conditioned on registration.
- * Applies to original purchaser/homeowner and not available to subsequent owners, except in jurisdictions where laws dictate otherwise.

See Warranty certificate for complete details and restrictions.

MODEL NUMBER NOMENCLATURE

1 2 3 4 5 6 7 8 9 10 11 12
 C V P M A 3 6 1 7 X M C

Product

C = Coil

Type

V = V-Coil

Refrigerant Type

P = Puron® Refrigerant (R-410A)

Coil Configuration

M = Multi-poise

Cabinet Finish

A = Major Series

Variations

N/A

Tubing Design

M= Microchannel

Metering Device

X = TXV

Cabinet Width (Nom.)

14 = 14-in (380 mm)

17 = 17-in (444 mm)

21 = 21-in (533 mm)

24 = 24-in (622 mm)

Unit Capacity (Nom.)

18 - 23 = 1½ Ton

24 - 29 = 2 Ton

30 - 35 = 2½ Ton

36 - 41 = 3 Ton

42 - 47 = 3½ Ton

48 - 51 = 4 Ton

60 - 62 = 5 Ton

Table 1 – Coil Connections / Orientations

Model	Nom. Tons	Line Set Connection Tube Size, in.		Flush Fit to Furnace Width, in. (mm)	Fits Next Smaller Furnace Width			90° Rotation to Furnace (4" Min. Transition Required)	180° Rotation to Furnace
		Suction	Liquid		Equal Overhang	Offset Left	Offset Right		
CVPMA2414XMC	2	3/4	3/8	14-3/16 (360)				ALL	
CVPMA2417XMC	2	3/4	3/8	17-1/2 (445)	X	X	X		
CVPMA2517XMC	2	3/4	3/8	17-1/2 (445)	X	X	X		
CVPMA3017XMC	2.5	3/4	3/8	17-1/2 (445)	X	X	X		
CVPMA3117XMC	2.5	3/4	3/8	17-1/2 (445)	X	X	X		
CVPMA3217XMC	2.5	3/4	3/8	17-1/2 (445)	X	X	X		
CVPMA3617XMC	3	3/4	3/8	17-1/2 (445)	X	X	X		
CVPMA4221XMC	3.5	7/8	3/8	21 (533)	X	X	X		
CVPMA4321XMC	3.5	7/8	3/8	21 (533)	X	X	X		
CVPMA4421XMC	3.5	7/8	3/8	21 (533)	X	X	X		
CVPMA4821XMC	4	7/8	3/8	21 (533)	X	X	X		
CVPMA4921XMC	4	7/8	3/8	21 (533)	X	X	X		
CVPMA6021XMC	5	7/8	3/8	21 (533)	X	X	X		
CVPMA6024XMC	5	7/8	3/8	24-1/2 (622)	X	X	X		
CVPMA6124XMC	5	7/8	3/8	24-1/2 (622)	X	X	X		

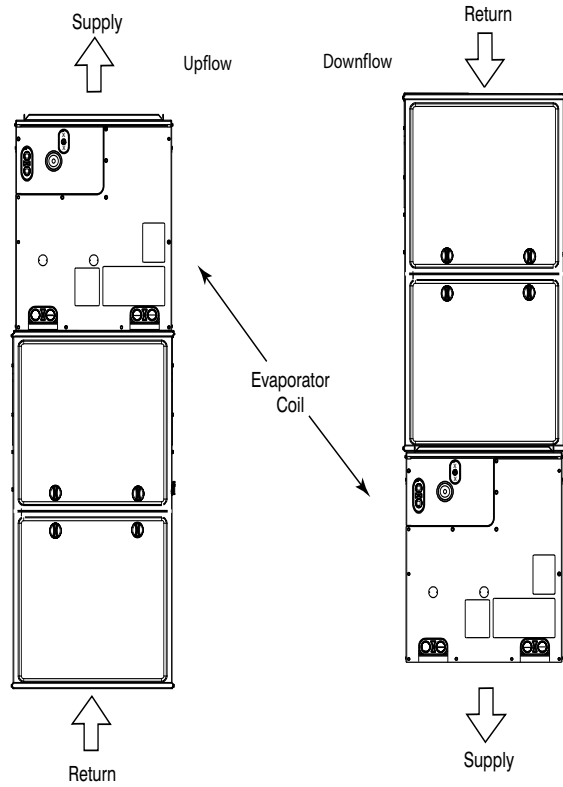

Fig. 2 – Typical Flush-Fit Coil Installation on Furnace (recommended) A221121A

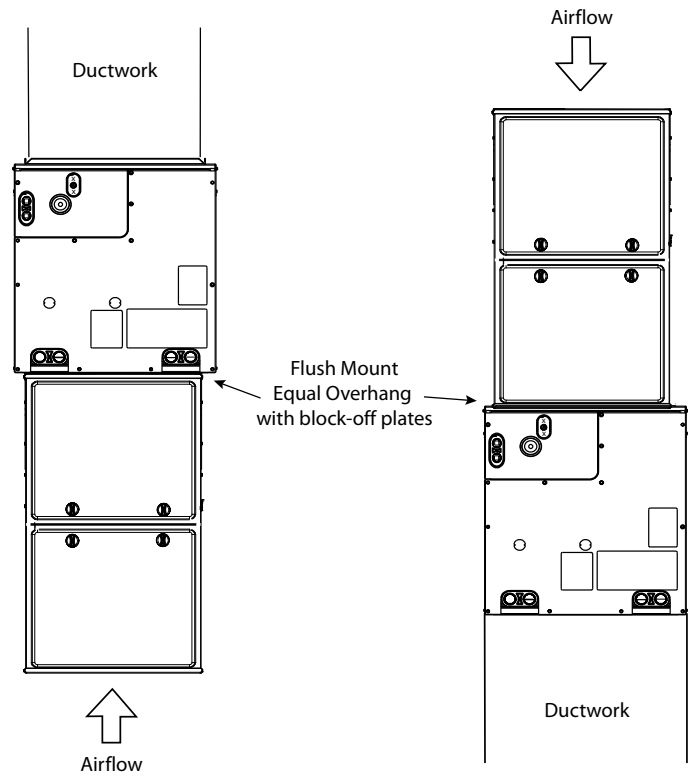

Fig. 4 – Smaller Furnace, Equal Overhang, Flush Mount (not recommended) A221123A

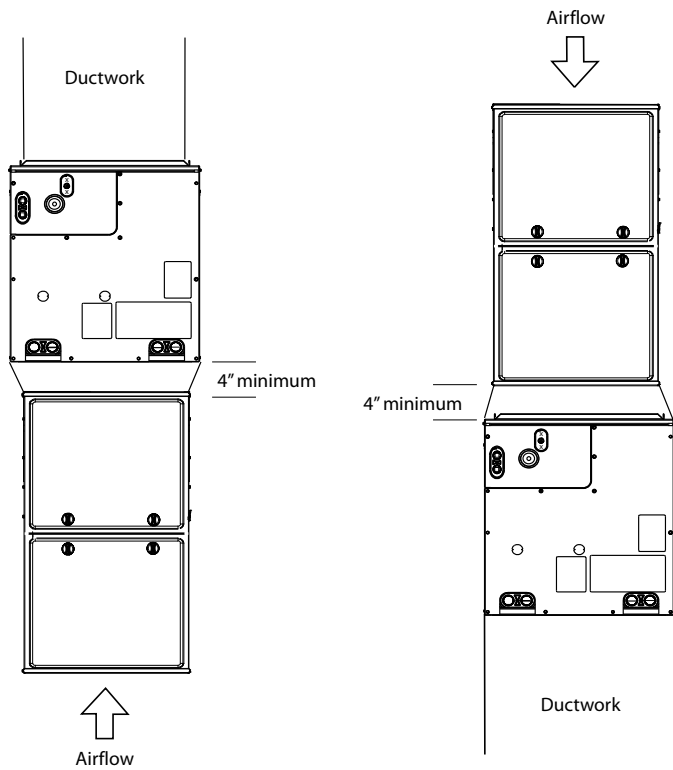

Fig. 3 – Adapter(s) Installation When Coil is Larger than Furnace (recommended) A221122A

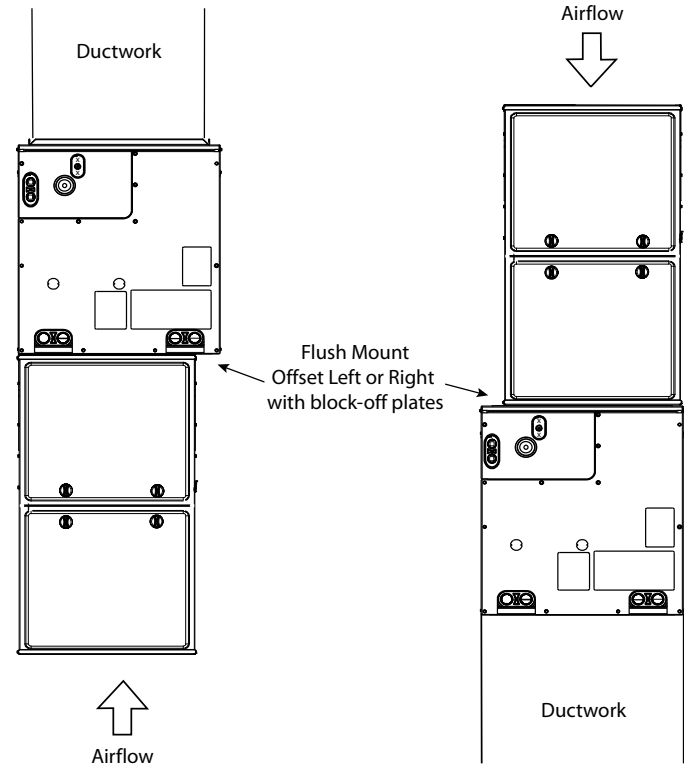
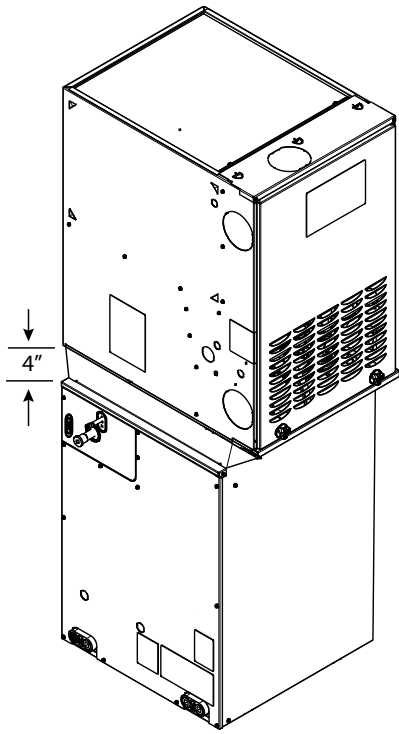
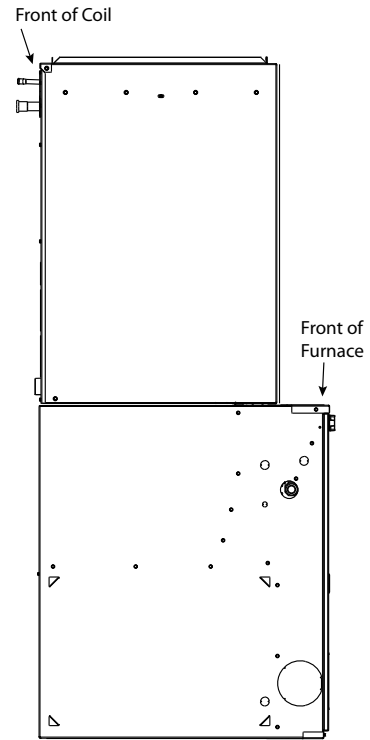

Fig. 5 – Smaller Furnace, Offset, Flush Mount Right or Left (not recommended) A221124A



**Fig. 6 – 90° Rotation (shown in downflow)
4\"**

A221125A



**Fig. 7 – 180° Rotation (shown in upflow)
(not recommended)**

A221111

Table 2 – Accessories

Part Number	Description
KGADA0101ALL	Coil Adapter Kits - No Offset
KGADA0201ALL	Coil Adapter Kits - Single Offset
KGADA0301ALL	Coil Adapter Kits - Double Offset

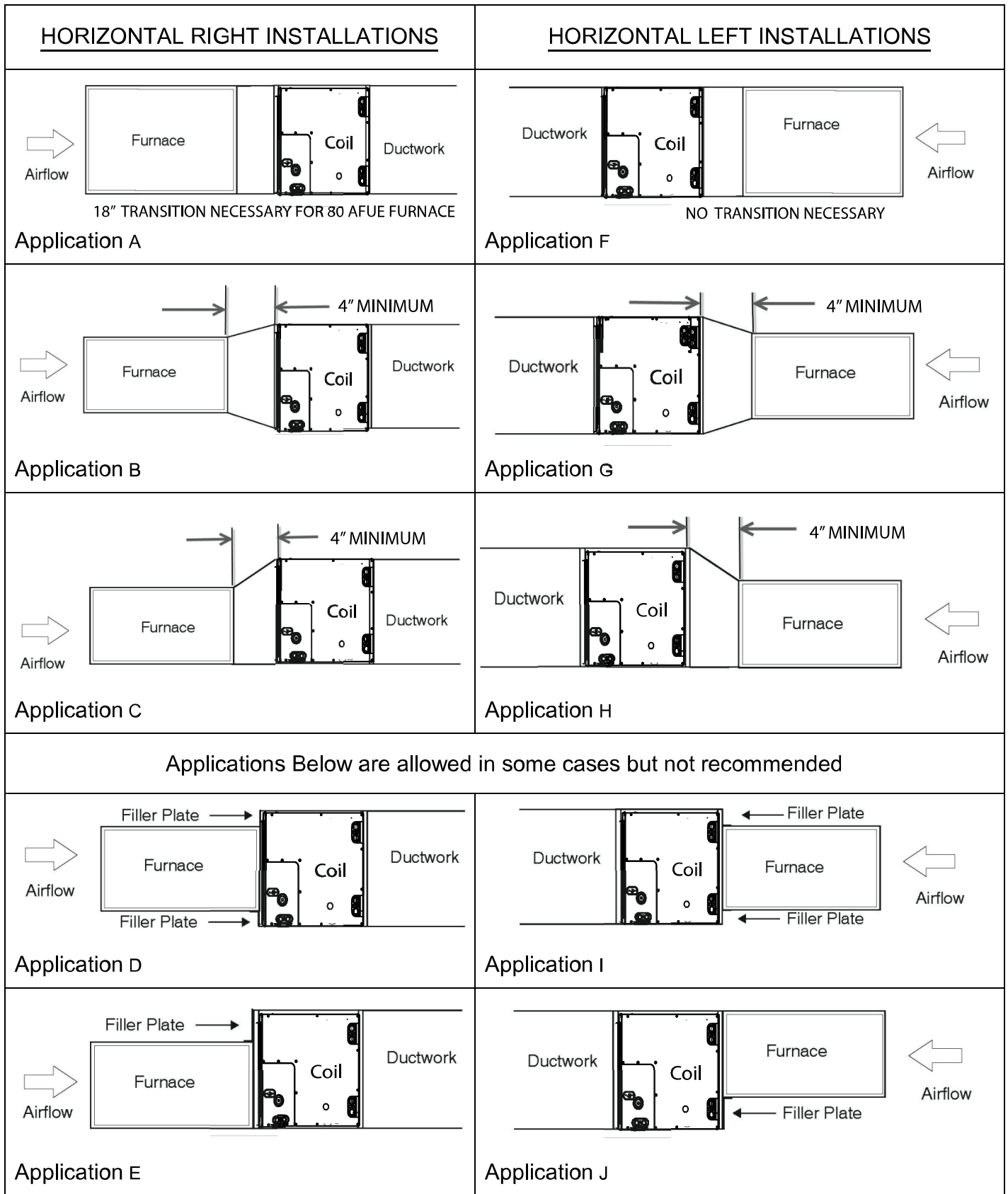

Fig. 8 – Horizontal Installation Examples

A221216C

DIMENSIONS

UNIT	SERIES	A		B (Cabinet Width)		C		D		E		F		H (Suction Line)		J		OPERATING WEIGHT		SHIPPING WEIGHT		SHIPPING HEIGHT		SHIPPING WIDTH		SHIPPING DEPTH	
		INCH	MM	INCH	MM	INCH	MM	INCH	MM	INCH	MM	INCH	MM	INCH	MM	INCH	MM	Lbs	Kgs	Lbs	Kgs	INCH	MM	INCH	MM	INCH	MM
CVPMA2414XMC	A	14 11/16	372.4	14 3/16	360.4	12 7/16	316.2	13 3/16	335.2	11 5/8	294.8	7 1/8	180.2	3/4	19.1	9 3/4	246.9	24.5	11.1	28.9	13.1	16.0	406.4	16.3	414.0	23.8	604.5
CVPMA2417XMC	A	14 11/16	372.4	17 1/2	444.5	15 3/4	400.3	13 3/16	335.2	11 5/8	294.8	8 3/4	222.3	3/4	19.1	9 3/4	246.9	33.1	15.0	39.3	17.8	16.0	406.4	19.6	497.8	23.8	604.5
CVPMA2517XMC	A	19 7/16	494.5	17 1/2	444.5	15 3/4	400.3	17 5/16	440.4	15 11/16	398.7	8 3/4	222.3	3/4	19.1	14 1/2	369.0	33.7	15.3	40.0	18.1	20.7	525.8	19.6	497.8	23.8	604.5
CVPMA3017XMC	A	19 7/16	494.5	17 1/2	444.5	15 3/4	400.3	17 5/16	440.4	15 11/16	398.7	8 3/4	222.3	3/4	19.1	14 1/2	369.0	33.7	15.3	40.0	18.1	20.7	525.8	19.6	497.8	23.8	604.5
CVPMA3117XMC	A	25 13/16	656.4	17 1/2	444.5	15 3/4	400.3	24 3/16	614.2	22 13/16	578.8	8 3/4	222.3	3/4	19.1	20 7/8	530.9	40.3	18.3	47.9	21.7	27.1	688.3	19.6	497.8	23.8	604.5
CVPMA3217XMC	A	29 3/4	755.3	17 1/2	444.5	15 3/4	400.3	27 3/4	704.9	26 11/16	677.7	8 3/4	222.3	3/4	19.1	24 13/16	629.8	45.1	20.5	53.6	24.3	31.0	787.4	19.6	497.8	23.8	604.5
CVPMA3617XMC	A	19 7/16	494.5	17 1/2	444.5	15 3/4	400.3	17 5/16	440.4	15 11/16	398.7	8 3/4	222.3	3/4	19.1	14 1/2	369.0	33.7	15.3	40.0	18.1	20.7	525.8	19.6	497.8	23.8	604.5
CVPMA4221XMC	A	19 1/16	483.4	21	533.4	19 1/4	489.2	16 7/8	427.9	16	405.8	10 1/2	266.7	7/8	22.2	14 1/16	357.9	34.4	15.6	40.9	18.5	20.4	518.2	23.1	586.7	23.8	604.5
CVPMA4321XMC	A	21 15/16	557.9	21	533.4	19 1/4	489.2	20 5/8	523.5	19	483.2	10 1/2	266.7	7/8	22.2	17 1/8	435.3	38.2	17.3	45.4	20.6	23.5	596.9	23.1	586.7	23.8	604.5
CVPMA4421XMC	A	29 3/4	755.3	21	533.4	19 1/4	489.2	28 1/4	717.0	26 11/16	677.7	10 1/2	266.7	7/8	22.2	24 13/16	629.8	47.6	21.6	56.5	25.6	31.0	787.4	23.1	586.7	23.8	604.5
CVPMA4821XMC	A	21 15/16	557.9	21	533.4	19 1/4	489.2	20 1/16	510.0	18 5/16	465.0	10 1/2	266.7	7/8	22.2	17 1/8	435.3	38.2	17.3	45.4	20.6	23.5	596.9	23.1	586.7	23.8	604.5
CVPMA4921XMC	A	29 3/4	755.3	21	533.4	19 1/4	489.2	28 1/4	717.0	26 11/16	677.7	10 1/2	266.7	7/8	22.2	24 13/16	629.8	47.6	21.6	56.5	25.6	31.0	787.4	23.1	586.7	23.8	604.5
CVPMA6021XMC	A	29 3/4	755.3	21	533.4	19 1/4	489.2	28 1/4	717.0	26 11/16	677.7	10 1/2	266.7	7/8	22.2	24 13/16	629.8	47.6	21.6	56.5	25.6	31.0	787.4	23.1	586.7	23.8	604.5
CVPMA6024XMC	A	26 5/16	669.0	24 1/2	622.3	22 3/4	578.1	24 3/4	629.3	23 5/16	591.4	12 1/4	311.2	7/8	22.2	21 3/8	543.5	44.7	20.3	53.0	24.1	27.7	703.6	26.6	675.6	23.8	604.5
CVPMA6124XMC	A	35	889.6	24 1/2	622.3	22 3/4	578.1	33 7/16	850.0	31 1/4	793.8	12 1/4	311.2	7/8	22.2	30 1/16	764.1	58.4	26.5	69.3	31.4	36.3	922.0	26.6	675.6	23.8	604.5

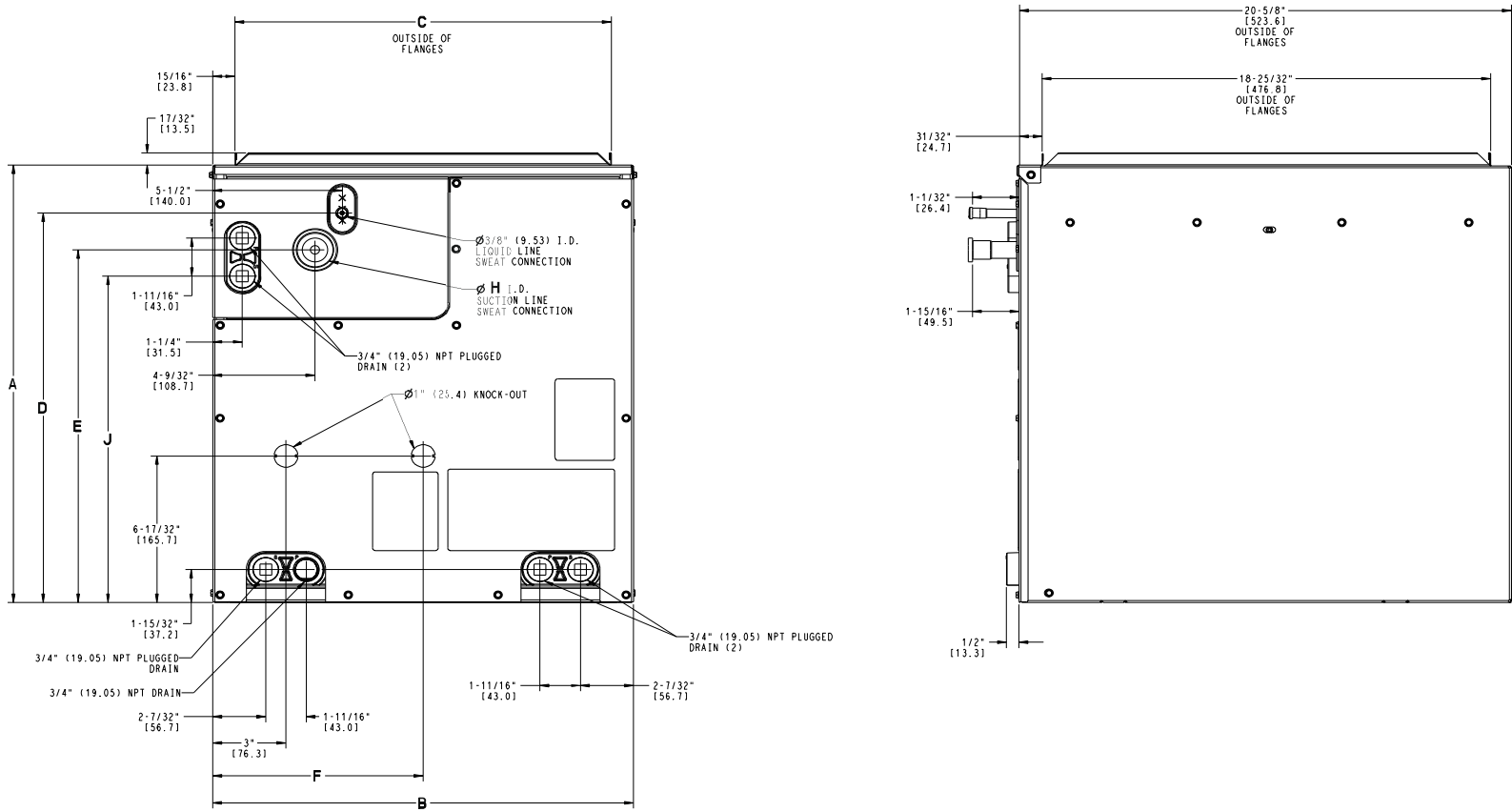

Fig. 9 – CVPMA Dimensions

WET COIL — INDOOR PERFORMANCE DATA - COIL STATIC PRESSURE DROP (in. w.c.) BY SCFM

Models	600	650	700	750	800	850	900	950	1000	1050	1100	1150	1200	1250	1300	1350	1400	1450	1500	1550	1600	1650	1700	1750	1800	1850	1900	1950	2000	2050	2100	2150	2200	2250	2300	2350	2400	2450	2500								
CVPMA2414XMC	.20	.23	.26	.29	.33	.37	.40	.44	.49																																						
CVPMA2417XMC	.15	.17	.19	.22	.24	.26	.29	.32	.35																																						
CVPMA2517XMC	.10	.12	.14	.15	.17	.19	.21	.23	.25																																						
CVPMA3017XMC				.15	.17	.19	.21	.23	.25	.28	.30	.32	.35	.38																																	
CVPMA3117XMC				.13	.15	.16	.18	.20	.21	.23	.25	.28	.30	.32																																	
CVPMA3217XMC				.11	.12	.13	.15	.16	.18	.20	.21	.23	.25	.27																																	
CVPMA3617XMC							.21	.23	.25	.28	.30	.32	.35	.38	.41	.43	.46	.49	.53																												
CVPMA4221XMC										.20	.21	.23	.25	.27	.29	.31	.33	.35	.37	.39	.42	.44	.46	.49																							
CVPMA4321XMC										.20	.22	.23	.25	.27	.29	.30	.32	.34	.36	.39	.41	.43	.45	.48																							
CVPMA4421XMC										.14	.15	.17	.18	.19	.21	.22	.24	.25	.27	.28	.30	.32	.33	.35																							
CVPMA4821XMC													.25	.27	.29	.30	.32	.34	.36	.39	.41	.43	.45	.48	.50	.52	.55	.58	.60																		
CVPMA4921XMC													.18	.19	.21	.22	.24	.25	.27	.28	.30	.32	.33	.35	.37	.39	.41	.43	.45																		
CVPMA6021XMC																			.27	.28	.30	.32	.33	.35	.37	.39	.41	.43	.45	.47	.49	.51	.53	.55	.58	.60	.62	.65	.67								
CVPMA6024XMC																			.21	.22	.24	.25	.26	.28	.29	.31	.32	.34	.36	.37	.39	.41	.43	.45	.46	.48	.50	.52	.54								
CVPMA6124XMC																			.16	.17	.18	.19	.21	.22	.23	.24	.25	.26	.27	.29	.30	.31	.32	.34	.35	.37	.38	.39	.41								

DRY COIL — INDOOR PERFORMANCE DATA - COIL STATIC PRESSURE DROP (in. w.c.) BY SCFM

Models	600	650	700	750	800	850	900	950	1000	1050	1100	1150	1200	1250	1300	1350	1400	1450	1500	1550	1600	1650	1700	1750	1800	1850	1900	1950	2000	2050	2100	2150	2200	2250	2300	2350	2400	2450	2500														
CVPMA2414XMC	.16	.19	.21	.24	.27	.30	.34	.37	.41																																												
CVPMA2417XMC	.12	.14	.15	.17	.19	.21	.23	.25	.28																																												
CVPMA2517XMC	.09	.10	.11	.13	.14	.16	.17	.19	.21																																												
CVPMA3017XMC				.13	.14	.16	.17	.19	.21	.23	.25	.27	.29	.31																																							
CVPMA3117XMC				.11	.12	.13	.15	.16	.18	.19	.21	.23	.24	.26																																							
CVPMA3217XMC				.09	.10	.12	.13	.14	.16	.17	.19	.20	.22	.24																																							
CVPMA3617XMC							.17	.19	.21	.23	.25	.27	.29	.31	.33	.36	.38	.40	.43																																		
CVPMA4221XMC										.16	.18	.19	.20	.22	.23	.25	.27	.28	.30	.32	.34	.35	.37	.39																													
CVPMA4321XMC										.16	.18	.19	.20	.22	.23	.25	.27	.28	.30	.32	.34	.36	.38	.40																													
CVPMA4421XMC										.12	.13	.14	.15	.17	.18	.19	.20	.22	.23	.25	.26	.28	.29	.31																													
CVPMA4821XMC													.20	.22	.23	.25	.27	.28	.30	.32	.34	.36	.38	.40	.42	.44	.46	.48	.50																								
CVPMA4921XMC													.15	.17	.18	.19	.20	.22	.23	.25	.26	.28	.29	.31	.32	.34	.36	.38	.39																								
CVPMA6021XMC																			.23	.25	.26	.28	.29	.31	.32	.34	.36	.38	.39	.41	.43	.45	.47	.49	.51	.53	.55	.58	.60														
CVPMA6024XMC																			.18	.19	.20	.21	.22	.23	.24	.26	.27	.28	.30	.31	.32	.34	.35	.37	.38	.40	.41	.43	.44														
CVPMA6124XMC																			.14	.15	.16	.17	.18	.19	.20	.21	.22	.23	.24	.25	.26	.27	.28	.30	.31	.32	.33	.35	.36														

Manufacturer reserves the right to change, at any time, specifications and designs without notice and without obligations.

Table 3 – Cooling Capacities (MBH) - PURON® Refrigerant (R-410A)

INDOOR COIL AIR		SATURATED TEMPERATURE LEAVING EVAPORATOR (deg F)														
		35			40			45			50			55		
CFM	EWB	TC	SHC	BF	TC	SHC	BF	TC	SHC	BF	TC	SHC	BF	TC	SHC	BF
CVPMA2414XMC																
600	72	38.06	18.85	0.00	34.74	17.01	0.00	30.37	14.96	0.00	25.46	12.83	0.31	19.95	10.60	0.26
	67	31.57	19.60	0.35	27.59	17.60	0.24	23.30	15.48	0.24	18.38	13.15	0.24	13.13	10.76	0.26
	62	25.08	20.08	0.22	21.25	17.92	0.22	16.96	15.69	0.23	13.39	13.39	0.24	11.00	11.00	0.37
800	72	46.08	22.66	0.00	42.15	20.53	0.00	36.86	18.08	0.00	31.01	15.61	0.36	24.45	12.99	0.31
	67	38.30	23.78	0.38	33.43	21.40	0.29	28.38	18.91	0.29	22.55	16.23	0.29	16.05	13.29	0.30
	62	30.58	24.57	0.27	26.09	22.10	0.27	20.62	19.29	0.28	16.79	16.79	0.28	13.96	13.96	0.40
1000	72	53.45	26.08	0.00	48.57	23.56	0.00	42.53	20.82	0.00	35.61	18.00	0.38	28.53	15.13	0.35
	67	44.07	27.42	0.39	38.67	24.74	0.34	32.81	21.93	0.33	26.00	18.85	0.32	18.67	15.61	0.33
	62	35.26	28.48	0.31	29.91	25.64	0.31	23.88	22.58	0.31	19.78	19.78	0.32	16.51	16.51	0.43
CVPMA2417XMC																
600	72	38.15	18.98	0.00	34.55	17.06	0.00	30.16	14.98	0.00	25.32	12.86	0.30	19.85	10.63	0.25
	67	31.36	19.64	0.33	27.39	17.61	0.23	23.16	15.50	0.22	18.30	13.18	0.23	13.14	10.84	0.24
	62	24.91	20.09	0.20	21.10	17.93	0.21	16.87	15.70	0.22	13.27	13.27	0.23	10.85	10.84	0.36
800	72	45.75	22.73	0.00	41.97	20.63	0.00	36.72	18.18	0.00	30.91	15.69	0.35	24.38	13.07	0.30
	67	38.12	23.87	0.37	33.36	21.47	0.29	28.28	18.98	0.28	22.48	16.30	0.27	16.03	13.35	0.29
	62	30.33	24.58	0.26	25.98	22.17	0.26	20.64	19.42	0.26	16.69	16.69	0.27	13.88	13.88	0.38
1000	72	53.13	26.16	0.00	48.37	23.66	0.00	42.38	20.94	0.00	35.70	18.12	0.39	28.52	15.24	0.34
	67	43.87	27.50	0.39	38.42	24.85	0.32	32.70	22.03	0.32	26.02	18.98	0.31	18.68	15.71	0.32
	62	35.13	28.59	0.30	29.82	25.75	0.30	23.91	22.73	0.30	19.71	19.71	0.30	16.44	16.44	0.41
CVPMA2517XMC																
600	72	45.24	22.02	0.00	40.81	19.79	0.00	35.80	17.43	0.00	30.31	15.06	0.27	23.95	12.54	0.19
	67	36.90	22.63	0.30	32.41	20.34	0.19	27.45	17.98	0.16	21.92	15.45	0.16	15.99	12.86	0.17
	62	29.37	23.18	0.15	25.13	20.86	0.15	20.13	18.31	0.15	15.96	15.96	0.15	13.12	13.12	0.30
800	72	54.18	26.47	0.00	49.85	24.04	0.00	43.92	21.33	0.00	37.29	18.53	0.31	29.62	15.54	0.23
	67	45.26	27.79	0.31	39.76	25.02	0.24	33.84	22.27	0.21	27.16	19.27	0.20	19.81	16.10	0.21
	62	36.09	28.67	0.20	30.98	25.91	0.20	24.85	22.88	0.20	20.05	20.05	0.20	16.80	16.80	0.32
1000	72	62.99	30.47	0.00	57.67	27.71	0.00	50.88	24.67	0.00	43.24	21.49	0.35	34.77	18.19	0.28
	67	52.20	32.12	0.33	45.98	29.05	0.28	39.27	25.96	0.25	31.57	22.56	0.24	23.01	18.90	0.25
	62	41.80	33.45	0.23	35.93	30.32	0.24	28.85	26.87	0.23	23.80	23.80	0.24	20.08	20.08	0.35

Table 3 – Cooling Capacities (MBH) - PURON® Refrigerant (R-410A) (Continued)

INDOOR COIL AIR		SATURATED TEMPERATURE LEAVING EVAPORATOR (deg F)														
		35			40			45			50			55		
CFM	EWB	TC	SHC	BF	TC	SHC	BF	TC	SHC	BF	TC	SHC	BF	TC	SHC	BF
CVPMA3017XMC																
750	72	50.66	25.13	0.00	45.80	22.64	0.00	40.27	20.06	0.00	34.00	17.31	0.30	27.21	14.56	0.23
	67	41.50	26.09	0.29	36.42	23.47	0.22	30.94	20.81	0.20	24.76	17.94	0.20	18.06	14.97	0.20
	62	33.09	26.86	0.18	28.35	24.21	0.19	22.71	21.31	0.19	18.10	18.10	0.20	15.13	15.12	0.32
1000	72	60.09	29.83	0.00	55.27	27.24	0.00	48.78	24.25	0.00	41.33	21.08	0.33	33.17	17.79	0.28
	67	50.10	31.54	0.33	44.17	28.59	0.27	37.64	25.46	0.25	30.22	22.09	0.24	22.11	18.55	0.25
	62	40.08	32.80	0.24	34.48	29.74	0.24	27.70	26.36	0.23	22.70	22.70	0.24	19.12	19.12	0.35
1250	72	68.19	33.71	0.00	63.11	31.00	0.00	55.83	27.72	0.00	47.41	24.18	0.37	37.82	20.45	0.31
	67	57.19	36.13	0.35	50.57	32.88	0.31	43.25	29.44	0.29	34.77	25.66	0.28	25.36	21.57	0.29
	62	45.90	37.91	0.28	39.34	34.45	0.28	31.81	30.70	0.27	26.82	26.82	0.28	22.57	22.57	0.39
CVPMA3117XMC																
750	72	48.31	23.38	0.00	43.93	21.18	0.00	38.71	18.80	0.00	32.87	16.31	0.23	26.11	13.66	0.17
	67	39.74	24.37	0.21	35.07	22.00	0.17	29.78	19.51	0.15	23.91	16.85	0.15	17.53	14.08	0.16
	62	31.75	25.08	0.13	27.29	22.68	0.14	22.00	20.03	0.14	17.25	17.25	0.16	14.43	14.43	0.29
1000	72	57.79	27.96	0.00	53.28	25.60	0.00	47.20	22.90	0.00	40.23	19.99	0.27	32.08	16.87	0.21
	67	48.28	29.69	0.25	42.74	26.97	0.21	36.52	24.11	0.19	29.51	21.01	0.19	21.78	17.74	0.19
	62	38.74	30.93	0.18	33.49	28.17	0.18	27.04	25.00	0.18	22.03	22.03	0.19	18.57	18.57	0.31
1250	72	66.42	31.88	0.00	61.12	29.29	0.00	54.24	26.33	0.00	46.38	23.12	0.30	37.15	19.63	0.25
	67	55.30	34.17	0.28	49.10	31.20	0.25	42.17	28.06	0.23	34.14	24.57	0.22	25.28	20.88	0.22
	62	44.57	35.98	0.22	38.39	32.80	0.22	31.26	29.35	0.21	26.13	26.12	0.23	22.08	22.08	0.35
CVPMA3217XMC																
900	72	50.34	24.62	0.00	45.67	22.22	0.00	40.36	19.75	0.00	34.36	17.12	0.25	27.42	14.34	0.16
	67	41.34	25.47	0.24	36.48	22.96	0.16	31.01	20.33	0.14	24.90	17.61	0.12	18.33	14.78	0.12
	62	32.95	26.12	0.11	28.28	23.60	0.11	22.74	20.79	0.11	17.81	17.81	0.13	14.86	14.86	0.26
1200	72	60.80	29.73	0.00	56.03	27.15	0.00	49.67	24.25	0.00	42.44	21.17	0.28	34.00	17.84	0.20
	67	50.71	31.32	0.25	44.92	28.41	0.20	38.34	25.31	0.17	30.93	22.06	0.16	22.84	18.66	0.16
	62	40.56	32.45	0.15	34.89	29.42	0.15	28.24	26.18	0.15	22.79	22.79	0.16	19.13	19.13	0.29
1500	72	70.75	34.21	0.00	64.80	31.30	0.00	57.50	28.06	0.00	49.30	24.64	0.30	39.62	20.89	0.23
	67	58.57	36.30	0.27	52.02	33.07	0.23	44.56	29.64	0.21	36.06	25.98	0.19	26.68	22.08	0.19
	62	46.98	37.94	0.19	40.61	34.64	0.19	32.87	30.92	0.18	27.50	27.50	0.19	23.15	23.15	0.31

Table 3 – Cooling Capacities (MBH) - PURON® Refrigerant (R-410A) (Continued)

INDOOR COIL AIR		SATURATED TEMPERATURE LEAVING EVAPORATOR (deg F)														
		35			40			45			50			55		
CFM	EWB	TC	SHC	BF	TC	SHC	BF	TC	SHC	BF	TC	SHC	BF	TC	SHC	BF
CVPMA3617XMC																
900	72	59.55	29.55	0.00	54.44	26.84	0.00	47.80	23.73	0.00	40.29	20.46	0.33	32.20	17.20	0.26
	67	49.33	30.93	0.37	43.24	27.81	0.26	36.66	24.63	0.24	29.32	21.26	0.23	21.36	17.74	0.23
	62	39.28	31.85	0.22	33.65	28.75	0.22	26.91	25.31	0.22	21.68	21.68	0.22	18.19	18.19	0.34
1200	72	71.40	35.22	0.00	65.42	32.08	0.00	57.59	28.52	0.00	48.64	24.69	0.38	38.60	20.76	0.31
	67	59.24	37.20	0.38	52.14	33.67	0.31	44.36	29.95	0.29	35.46	25.94	0.28	25.80	21.73	0.28
	62	47.29	38.66	0.27	40.38	34.97	0.27	32.51	31.01	0.27	26.94	26.94	0.27	22.67	22.67	0.38
1500	72	81.69	39.99	0.00	74.74	36.49	0.00	65.86	32.58	0.00	55.79	28.36	0.41	44.31	23.93	0.34
	67	67.67	42.61	0.40	59.64	38.67	0.35	50.88	34.56	0.33	40.67	30.02	0.32	29.67	25.32	0.32
	62	54.19	44.68	0.31	46.62	40.62	0.31	37.27	36.04	0.31	31.49	31.49	0.31	26.59	26.59	0.42
CVPMA4221XMC																
900	72	67.79	33.30	0.00	61.46	30.13	0.00	53.97	26.70	0.00	45.68	23.14	0.36	36.22	19.42	0.28
	67	55.62	34.83	0.39	48.84	31.40	0.29	41.53	27.93	0.26	33.24	24.17	0.25	24.28	20.29	0.25
	62	44.37	36.06	0.24	37.80	32.52	0.24	30.43	28.80	0.24	24.94	24.94	0.24	20.94	20.94	0.36
1200	72	79.88	39.09	0.00	73.16	35.70	0.00	64.43	31.80	0.00	54.67	27.73	0.40	43.49	23.40	0.33
	67	66.20	41.59	0.39	58.32	37.68	0.34	49.72	33.65	0.32	39.90	29.31	0.30	29.02	24.63	0.30
	62	52.97	43.49	0.30	45.23	39.41	0.30	36.47	35.07	0.29	30.68	30.68	0.30	25.90	25.90	0.40
1500	72	89.44	43.70	0.00	82.93	40.37	0.00	73.30	36.18	0.00	62.24	31.63	0.43	49.48	26.79	0.37
	67	75.08	47.39	0.41	66.36	43.15	0.37	56.74	38.71	0.35	45.40	33.78	0.34	33.13	28.56	0.34
	62	60.13	49.92	0.34	51.46	45.48	0.33	41.63	40.66	0.33	35.61	35.61	0.34	30.13	30.13	0.44
CVPMA4321XMC																
1050	72	70.28	34.36	0.00	64.15	31.27	0.00	56.49	27.78	0.00	47.93	24.14	0.32	38.05	20.27	0.25
	67	58.02	36.11	0.32	51.12	32.64	0.25	43.52	29.07	0.23	34.96	25.23	0.22	25.60	21.19	0.22
	62	46.37	37.43	0.21	39.66	33.84	0.21	32.02	30.01	0.21	26.09	26.09	0.21	21.93	21.93	0.34
1400	72	83.31	40.51	0.00	76.53	37.14	0.00	67.60	33.19	0.00	57.51	29.01	0.36	45.83	24.52	0.30
	67	69.28	43.27	0.35	61.12	39.24	0.31	52.25	35.18	0.28	42.08	30.70	0.27	30.75	25.84	0.27
	62	55.52	45.32	0.27	47.85	41.26	0.26	38.51	36.72	0.26	32.22	32.22	0.27	27.28	27.28	0.38
1750	72	92.84	45.11	0.00	86.66	41.96	0.00	76.82	37.73	0.00	65.45	33.09	0.39	52.13	28.09	0.34
	67	78.47	49.27	0.37	69.51	44.95	0.34	59.56	40.44	0.32	47.89	35.39	0.31	35.16	30.02	0.31
	62	63.13	52.13	0.31	54.12	47.55	0.30	43.87	42.55	0.30	37.50	37.50	0.31	31.89	31.89	0.41

Table 3 – Cooling Capacities (MBH) - PURON® Refrigerant (R-410A) (Continued)

INDOOR COIL AIR		SATURATED TEMPERATURE LEAVING EVAPORATOR (deg F)														
		35			40			45			50			55		
CFM	EWB	TC	SHC	BF	TC	SHC	BF	TC	SHC	BF	TC	SHC	BF	TC	SHC	BF
CVPMA4421XMC																
1050	72	73.68	35.84	0.00	67.17	32.64	0.00	59.57	29.21	0.00	50.91	25.51	0.28	40.79	21.54	0.20
	67	60.77	37.71	0.25	53.86	34.23	0.20	46.01	30.55	0.18	37.09	26.64	0.16	27.42	22.53	0.16
	62	48.65	39.17	0.16	41.75	35.53	0.15	33.92	31.65	0.15	27.52	27.51	0.17	23.16	23.16	0.29
1400	72	87.61	42.39	0.00	80.40	38.95	0.00	71.52	35.05	0.00	61.40	30.87	0.31	49.41	26.28	0.24
	67	72.70	45.37	0.28	64.69	41.45	0.25	55.54	37.29	0.22	45.03	32.78	0.21	33.38	27.94	0.20
	62	58.42	47.69	0.21	50.62	43.68	0.20	41.05	39.10	0.20	34.77	34.77	0.21	29.31	29.31	0.32
1750	72	99.07	47.72	0.00	91.05	44.08	0.00	81.20	39.87	0.00	69.92	35.32	0.34	56.46	30.28	0.28
	67	82.26	51.69	0.31	73.40	47.45	0.28	63.24	42.97	0.26	51.47	38.02	0.25	38.31	32.66	0.24
	62	66.35	54.98	0.24	57.33	50.53	0.24	46.89	45.58	0.23	40.79	40.79	0.25	34.59	34.59	0.36
CVPMA4821XMC																
1200	72	73.87	35.91	0.00	67.26	32.69	0.00	59.32	29.10	0.00	50.53	25.40	0.35	40.27	21.41	0.28
	67	60.80	37.84	0.35	53.64	34.26	0.28	45.78	30.63	0.25	36.83	26.68	0.24	27.06	22.53	0.24
	62	48.63	39.41	0.24	41.58	35.70	0.23	33.61	31.77	0.23	27.83	27.83	0.23	23.56	23.56	0.35
1600	72	85.80	41.62	0.00	79.40	38.44	0.00	70.40	34.51	0.00	60.05	30.24	0.39	48.05	25.71	0.32
	67	71.91	44.97	0.37	63.61	40.91	0.33	54.43	36.75	0.31	43.93	32.24	0.29	32.18	27.29	0.29
	62	57.60	47.29	0.29	49.42	43.11	0.28	40.07	38.60	0.28	34.55	34.55	0.28	29.07	29.07	0.39
2000	72	96.29	46.56	0.00	89.52	43.29	0.00	79.58	39.08	0.00	68.10	34.44	0.42	55.12	29.51	0.37
	67	80.98	51.00	0.39	71.92	46.66	0.37	61.79	42.16	0.35	49.89	37.15	0.33	36.81	31.75	0.33
	62	65.18	54.29	0.33	55.93	49.66	0.32	45.77	44.98	0.31	40.04	40.04	0.33	33.77	33.77	0.43
CVPMA4921XMC																
1200	72	76.69	37.29	0.00	70.10	34.13	0.00	62.14	30.54	0.00	53.12	26.75	0.29	42.53	22.64	0.22
	67	63.28	39.47	0.26	56.15	35.92	0.22	48.08	32.21	0.20	38.83	28.14	0.18	28.78	23.89	0.18
	62	50.79	41.25	0.18	43.70	37.53	0.18	35.51	33.50	0.17	29.45	29.45	0.18	24.70	24.70	0.31
1600	72	90.24	43.69	0.00	83.01	40.36	0.00	73.96	36.41	0.00	63.46	32.10	0.32	51.03	27.40	0.26
	67	75.09	47.18	0.29	66.84	43.19	0.27	57.45	38.96	0.24	46.66	34.35	0.23	34.66	29.34	0.23
	62	60.45	49.90	0.23	52.17	45.70	0.22	42.55	41.06	0.22	36.54	36.54	0.23	30.87	30.87	0.35
2000	72	101.35	48.91	0.00	93.30	45.31	0.00	83.34	41.15	0.00	71.79	36.52	0.35	57.74	31.34	0.30
	67	84.36	53.48	0.32	75.34	49.22	0.30	65.05	44.69	0.28	52.93	39.60	0.27	39.32	33.98	0.27
	62	68.08	57.16	0.27	58.98	52.71	0.26	48.56	47.94	0.25	42.62	42.62	0.28	36.18	36.18	0.39

Table 3 – Cooling Capacities (MBH) - PURON® Refrigerant (R-410A) (Continued)

INDOOR COIL AIR		SATURATED TEMPERATURE LEAVING EVAPORATOR (deg F)														
		35			40			45			50			55		
CFM	EWB	TC	SHC	BF	TC	SHC	BF	TC	SHC	BF	TC	SHC	BF	TC	SHC	BF
CVPMA6021XMC																
1500	72	91.48	44.44	0.00	83.87	40.87	0.00	74.51	36.77	0.00	63.91	32.41	0.31	51.31	27.60	0.25
	67	75.74	47.66	0.28	67.39	43.58	0.26	57.89	39.30	0.23	46.89	34.51	0.22	34.82	29.46	0.22
	62	61.01	50.32	0.22	52.89	46.18	0.21	42.93	41.32	0.21	36.48	36.48	0.22	30.79	30.79	0.34
2000	72	105.88	51.23	0.00	97.62	47.57	0.00	87.16	43.17	0.00	75.02	38.32	0.35	60.55	32.95	0.30
	67	88.23	56.12	0.32	78.82	51.67	0.30	67.98	46.90	0.28	55.43	41.62	0.27	41.09	35.62	0.27
	62	71.25	60.01	0.27	61.74	55.34	0.26	50.91	50.42	0.25	44.60	44.60	0.28	37.85	37.85	0.39
2500	72	117.33	56.78	0.00	108.41	53.00	0.00	97.11	48.40	0.45	83.89	43.22	0.38	67.74	37.37	0.33
	67	98.07	63.18	0.35	87.81	58.45	0.34	76.12	53.45	0.32	62.18	47.69	0.31	46.32	41.15	0.31
	62	79.44	68.37	0.31	68.98	63.42	0.30	58.14	58.14	0.26	52.01	52.00	0.33	43.95	43.95	0.43
CVPMA6024XMC																
1500	72	95.05	47.18	0.00	86.49	43.00	0.00	76.55	38.48	0.00	65.38	33.70	0.35	51.86	28.42	0.27
	67	78.43	50.08	0.34	69.21	45.39	0.29	59.16	40.67	0.26	47.65	35.57	0.24	35.04	30.13	0.24
	62	62.48	52.17	0.24	53.93	47.59	0.24	43.48	42.45	0.23	36.52	36.52	0.23	30.90	30.90	0.35
2000	72	110.73	54.63	0.00	101.58	50.38	0.00	90.20	45.36	0.00	77.27	39.99	0.39	62.03	34.13	0.32
	67	91.79	59.02	0.37	81.54	53.95	0.33	69.87	48.63	0.31	56.53	42.89	0.29	41.61	36.55	0.29
	62	73.61	62.44	0.29	63.34	57.26	0.28	51.39	51.36	0.28	45.11	45.11	0.29	38.01	38.01	0.39
2500	72	122.60	60.37	0.00	113.83	56.48	0.00	101.48	51.19	0.00	87.16	45.35	0.41	69.91	38.89	0.36
	67	102.94	66.78	0.39	91.68	61.38	0.37	78.81	55.62	0.35	63.73	49.18	0.33	47.11	42.25	0.33
	62	82.83	71.48	0.33	71.33	65.79	0.32	59.65	61.14	0.30	51.69	51.69	0.34	43.99	43.99	0.44
CVPMA6124XMC																
1500	72	94.46	45.65	0.00	86.26	41.81	0.00	76.80	37.61	0.00	65.93	33.10	0.30	53.14	28.19	0.23
	67	77.91	48.53	0.27	69.38	44.37	0.23	59.55	39.89	0.21	48.22	35.07	0.19	35.85	29.95	0.18
	62	62.60	51.02	0.19	53.97	46.63	0.18	43.99	41.83	0.18	37.12	37.12	0.19	31.34	31.34	0.31
2000	72	110.16	52.98	0.00	101.33	49.08	0.00	90.57	44.50	0.00	78.09	39.47	0.33	63.23	33.91	0.27
	67	91.60	57.64	0.30	81.85	53.03	0.27	70.60	48.04	0.25	57.38	42.57	0.24	42.80	36.62	0.23
	62	73.76	61.30	0.24	63.81	56.46	0.23	52.76	51.59	0.22	45.76	45.76	0.25	38.83	38.83	0.36
2500	72	122.87	59.05	0.00	113.06	54.89	0.00	101.33	50.02	0.00	87.66	44.67	0.35	71.21	38.64	0.31
	67	102.27	65.08	0.33	91.57	60.13	0.31	79.23	54.80	0.29	64.58	48.89	0.27	48.31	42.31	0.27
	62	82.54	69.99	0.28	71.56	64.86	0.27	60.86	60.73	0.25	53.27	53.27	0.29	45.29	45.29	0.40

CFM - Cubic Ft. per Minute **EWB** - Entering Wet Bulb (°F) **LWB** - Leaving Wet Bulb (°F) **TC** - Gross Cooling Capacity 1000 Btuh
SHC - Gross Sensible Capacity 1000 Btuh **BF** - Bypass Factor **MBH** - 1000 Btuh

COOLING CAPACITIES NOTES:

1. Contact manufacturer for cooling capacities at conditions other than shown in table.
2. Formulas:
 Leaving db = entering db - $\frac{\text{sensible heat cap.}}{1.09 \times \text{CFM}}$
 Leaving wb = wb corresponding to enthalpy of air leaving coil (h_{LWB})

 $h_{LWB} = h_{EWB} - \frac{\text{total capacity (Btuh)}}{4.5 \times \text{CFM}}$
 Where h_{EWB} = enthalpy of air entering coil
3. SHC is based on 80°F db temperature of air entering the evaporator coil.
 Below 80°F db, subtract (Correction Factor x CFM) from SHC.
 Above 80°F db, add (Correction Factor x CFM) to SHC.
4. Direct interpolation is permissible. Do not extrapolate.
5. Fan motor heat has not been deducted.
6. All data points are based on approximately 10°F superheat measured at the suction service valve and use of thermostatic expansion valve (TXV) device.
7. All units have sweat suction-tube connection and a liquid-tube connection. For 1-1/8-in. system suction tube, 3/4 x 1-1/8-in. suction tube connection adapter is available as accessory.
8. Before using maximum cfm shown in table, check coil static pressure drop to ensure system blower can provide necessary static pressure needed for coil and duct systems.
9. Bypass Factor = 0 indicates no psychometric solution. Use bypass factor of next lower EWB for approximation.

BYPASS FACTOR	ENTERING AIR DRY BULB TEMPERATURE (°F)					
	79	78	77	76	75	Under 75
	81	82	83	84	84	Above 85
Correction Factor						
0.10	0.98	1.96	2.94	3.92	4.91	Use formula shown below
0.20	0.87	1.74	2.62	3.49	4.36	
0.30	0.76	1.53	2.29	3.05	3.82	

Interpolation is permissible.

$$\text{Correction Factor} = 1.09 \times (1 - \text{BF}) \times (\text{db} - 80)$$