

# HydroCal™ combination hydraulic, air and dirt separator

## 549 and NA549 series



01178/14 NA  
Replaces 01178/13 NA



### Product range

- 549 series HydroCal™ hydraulic, air and dirt separator in steel with flanged connections, drain and insulation ..... connections 2–4" ANSI
- NA549 series HydroCal™ hydraulic, air and dirt separator in steel with flanged connections, drain and insulation, ASME and CRN ..... connections 2–4" ANSI
- NA549 series HydroCal™ hydraulic, air and dirt separator in steel with flanged connections and drain, ASME and CRN ..... connections 6–12" ANSI

### Technical specifications

- Connections** - flanged: 2–12" ANSI B16.5 150 CLASS RF  
 - drain valve: 2–6": 1-1/4" NPT female  
 8–12": 2" NPT female  
 - thermometer pockets: 1/2" (8–12" only)  
 front center: 3/4" NPT female  
 inlet/outlet flanges: 1/2" NPT female
- Materials** - separator body: epoxy resin painted steel body  
 - air vent body: brass  
 - shut-off and drain valve body: brass  
 - internal element: 300 series stainless steel  
 - air vent seal: VITON  
 - air vent float: stainless steel

### Performance

- Suitable fluids: water and non-hazardous glycol solutions up to 50%  
 Max. operating pressure: 150 psi (10 bar)  
 Max. connection velocity: 4 feet per second (1.2 m/s)  
 Temperature range: - with insulation 32–220°F (0–105°C)  
 - without insulation (vessel) 32–270°F (0–132°C)  
 Particle separation capacity: to 5 µm (0.2 mil)  
 Air separation capacity: 100% removal to micro-bubble level

### Agency approval

Series NA549 is designed and built in accordance with Section VIII, Division 1 of the ASME Boiler and Pressure Vessel Code and tagged and registered with the National Board of Boiler and Pressure Vessel Inspector, and CRN registered, and stamped for 150 psi (10 bar) working pressure, with ASME U stamp.

### Technical specifications of insulation

#### Inner part

- Material: rigid closed cell expanded polyurethane foam  
 Thickness: 2-3/8" (60 mm)  
 Density: 3 lb/ft<sup>3</sup> (45 kg/m<sup>3</sup>)  
 Conductivity (ISO 2581): 0.16 BTU-in/hr-ft<sup>2</sup>-°F (0.023 W/(m-K))  
 Temperature range: 32–220°F (0–105°C)

#### Outer part

- Material: embossed aluminium  
 Thickness: 7-mil (0.70 mm)  
 Fire resistance (DIN 4102): class 1

#### Head covers

- Heat formed material: PS

### Function

The Caleffi HydroCal™ combination hydraulic, air and dirt separator is a device that combines high performance air and dirt removal with hydraulic separation. Primary and secondary circuits connected to it become hydraulically decoupled thus eliminating pump conflict.

A proven, time tested stainless steel internal coalescing element continuously and automatically eliminates all entrained air, including microbubbles, in the system. Air discharge capacity is very high. Over time, dirt particles as tiny as 5 microns are captured and collected away from the flow stream.

The 3-in-1 high performance functionality of the HydroCal™ saves system installation and maintenance cost as there is no need to include separate air and dirt separators. It can be used on either hot or chilled water systems.

### Dimensions

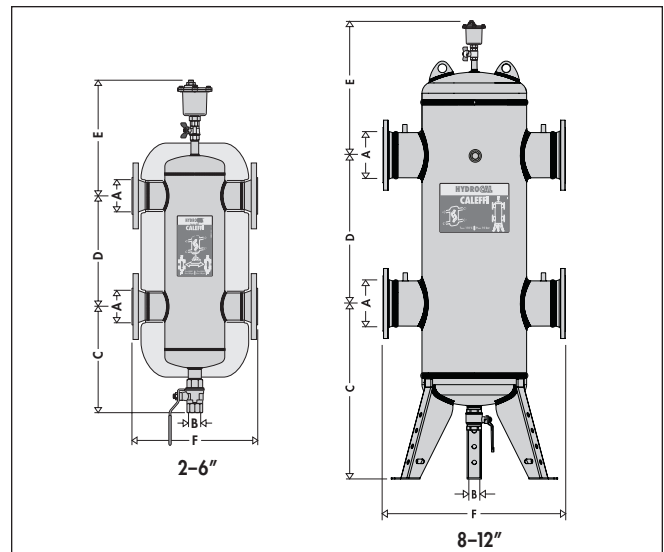

Code	A	B	C	D	E	F	Wt. (lbs.)	Flow (gpm)	Vol (gal.)
549052A	2"	1 1/4"	13"	13"	15"	14"	73	37.3	4.0
549062A	2 1/2"	1 1/4"	13"	13"	15"	14"	79	63	4.0
549082A	3"	1 1/4"	15"	17 3/4"	17"	18"	108	95.5	8.0
549102A	4"	1 1/4"	15"	17 3/4"	17"	18"	117	149	8.0
NA549150A*	6"	1 1/4"	15"	22"	19"	25"	231	380	23.2
NA549200A*	8"	2"	33 3/8"	39 3/8"	27 1/2"	35 1/2"	520	625	95.0
NA549250A*	10"	2"	33 3/8"	43 3/8"	30"	41 3/4"	725	1,030	175
NA549300A*	12"	2"	33 3/8"	47 1/4"	31 1/2"	47 3/4"	1100	1,650	255

\*Without insulation

NA prefix indicates ASME tagged and registered with the National Board of Boiler and Pressure Vessel Inspectors and CRN registered, with ASME U stamp.

Add NA prefix to 2" to 4" flanged connection for ASME approved, CRN registered.

Larger sizes available, consult with factory.

## Operating principle

### Hydraulic separation

When a single system contains a primary production circuit, with its own pump, and a secondary user circuit, with one or more distribution pumps, operating conditions may arise in the system whereby the pumps interact, creating abnormal variations in circuit flow rates and pressures. The hydraulic separator creates a zone with a low pressure loss, which enables the primary and secondary circuits connected to it to be hydraulically independent of each other; **the flow in one circuit does not affect flow in the other.**

In this case, the flow rate in the respective circuits depends exclusively on the flow rate characteristics of the circuit pumps, preventing reciprocal influence caused by connection in series. Therefore, using a device with these characteristics means that the flow in the secondary circuit only circulates when the relevant pump is on, permitting the system to meet the specific load requirements at that time.

When the secondary pump is off, there is no circulation in the secondary circuit; the whole flow rate produced by the primary pump is by-passed

through the separator. With the hydraulic separator, it is therefore possible to have a primary production circuit with a constant flow rate and a secondary distribution circuit with a variable flow rate; these operating conditions are typical of modern heating and cooling systems.

Three possible hydraulic balance situations are shown below.

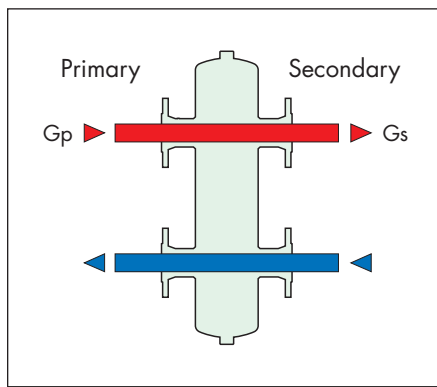
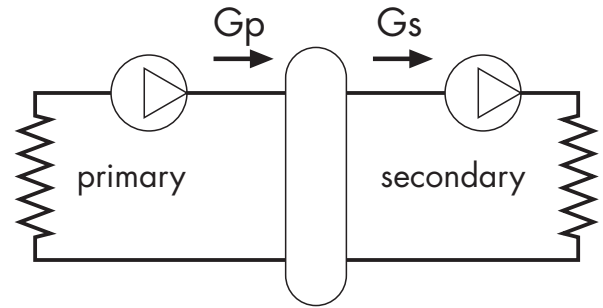

$G_{primary} = G_{secondary}$

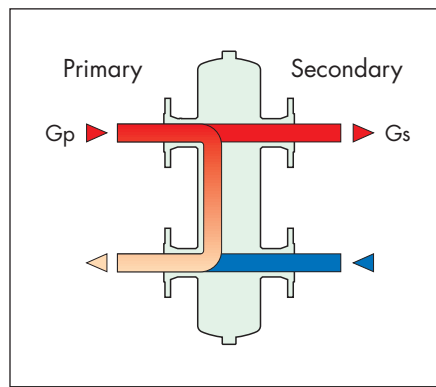

$G_{primary} > G_{secondary}$

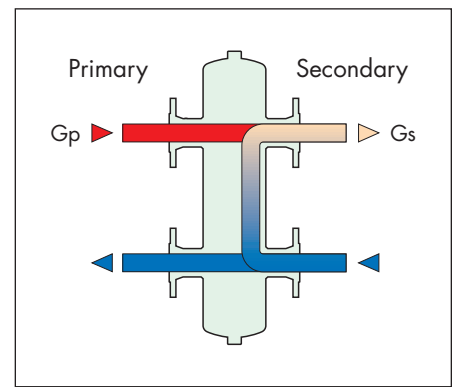

$G_{primary} < G_{secondary}$

### Microbubble air separation

The HydroCal's internal element (1) creates the whirling movement required to facilitate the release of microbubbles and their adhesion to the internal element surfaces. The bubbles, fusing with each other, increase in size until the hydrostatic thrust overcomes the adhesion force to the mesh. They rise towards the top of the unit from which they are released through a float-operated automatic air vent.

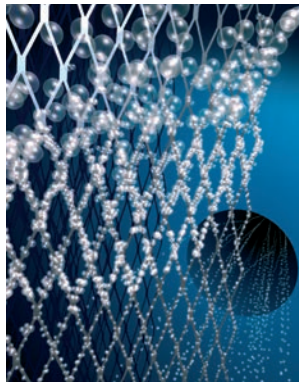

### Microparticle dirt separation

Impurities in the fluid upon striking the surfaces of the HydroCal's internal element (1), get separated and drop to the bottom of the body (2) where they collect.

In addition, the large internal volume of HydroCal™ slows down the flow speed of the fluid thus helping, by gravity, to separate the particles it contains.

The collected impurities are discharged, by opening the drain valve (3) with the handle (4), even with the system operating.

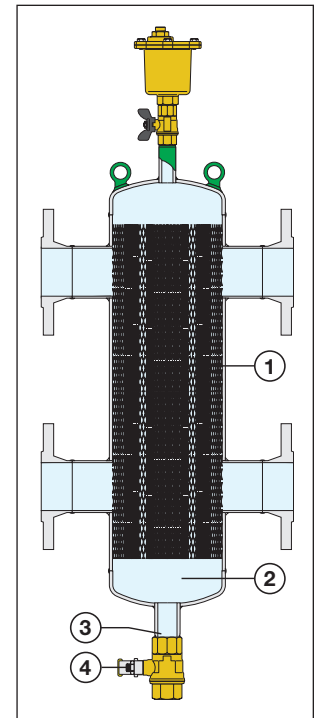

**Construction details**

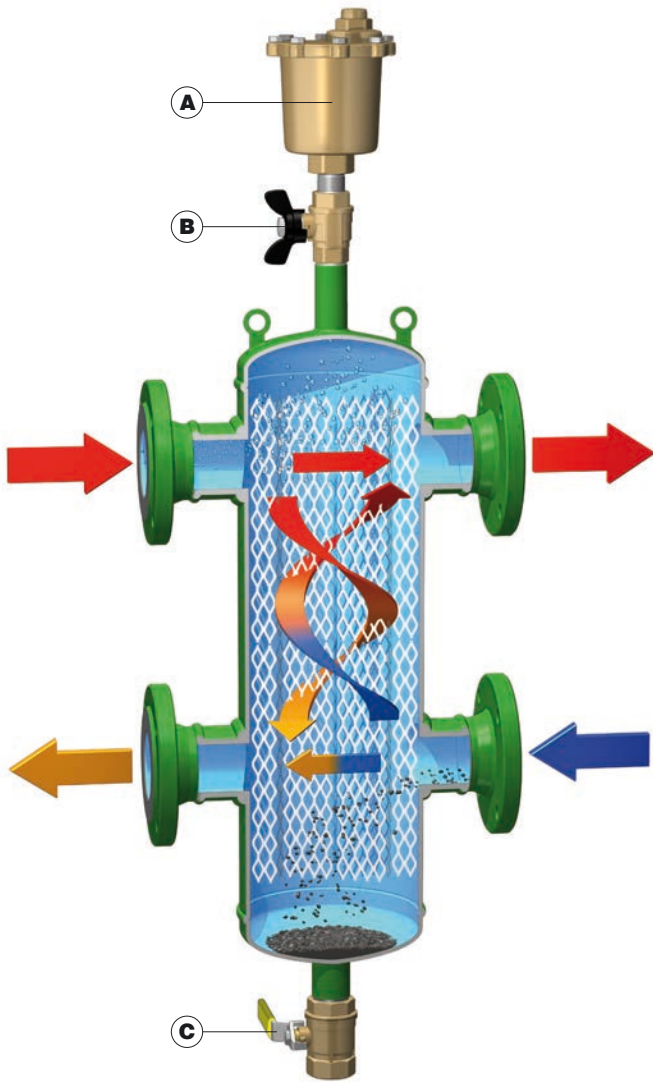

**Isolating the air vent valve**

The air vent (A), replacement part number 501502A, is isolated manually, using a shut-off ball valve (B), replacement part number NA39589.

**Dirt removing element**

The HydroCal™ dirt removing element separates and collects any impurities present in the system.

These impurities are removed by the drain valve (C) replacement part number NA39588 for connection sizes 2–6"; NA59600 for connection size 8–12", which can be connected to a discharge pipe, at the bottom of the separator.

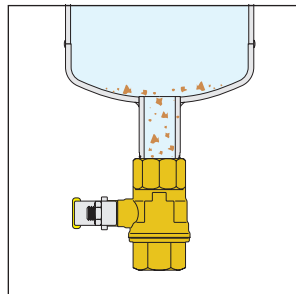

**Insulation**

The HydroCal™ is available complete with a hot preformed insulation shell. In the flanged series, sizes 2" to 4", the insulation is made of a shell in expanded polyurethane foam covered with an aluminium layer. This insulation ensures not only perfect heat insulation but also the tightness required to prevent atmospheric water vapors from entering the unit. For these reasons, this type of insulation can also be used in cooling water circuits, as it prevents the formation of condensate on the surface of the separator body.

NOTE: Insulation shells are not available for sizes 6" through 12".

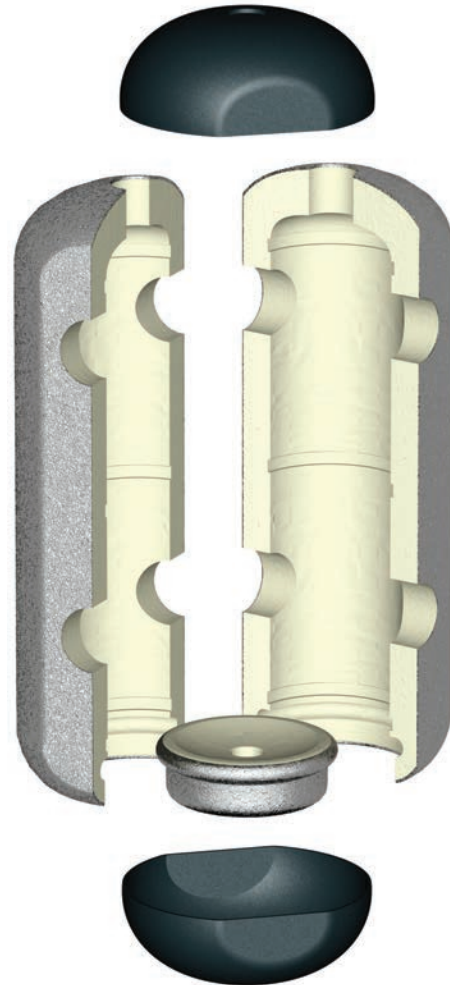

**Hydraulic characteristics**

The HydroCal™ should be sized according to the maximum flow rate value at the inlet. The selected design value must be the greatest required flow rate of either the primary circuit or the secondary circuit.

Size	2"	2½"	3"	4"	6"	8"	10"	12"
gpm	37.3	63	95.5	149	380	625	1030	1650
m³/h	8.5	14	22	34	86	142	302	420
l/s	2.3	4.0	6.0	9.4	24	40	83	104

## Application diagram

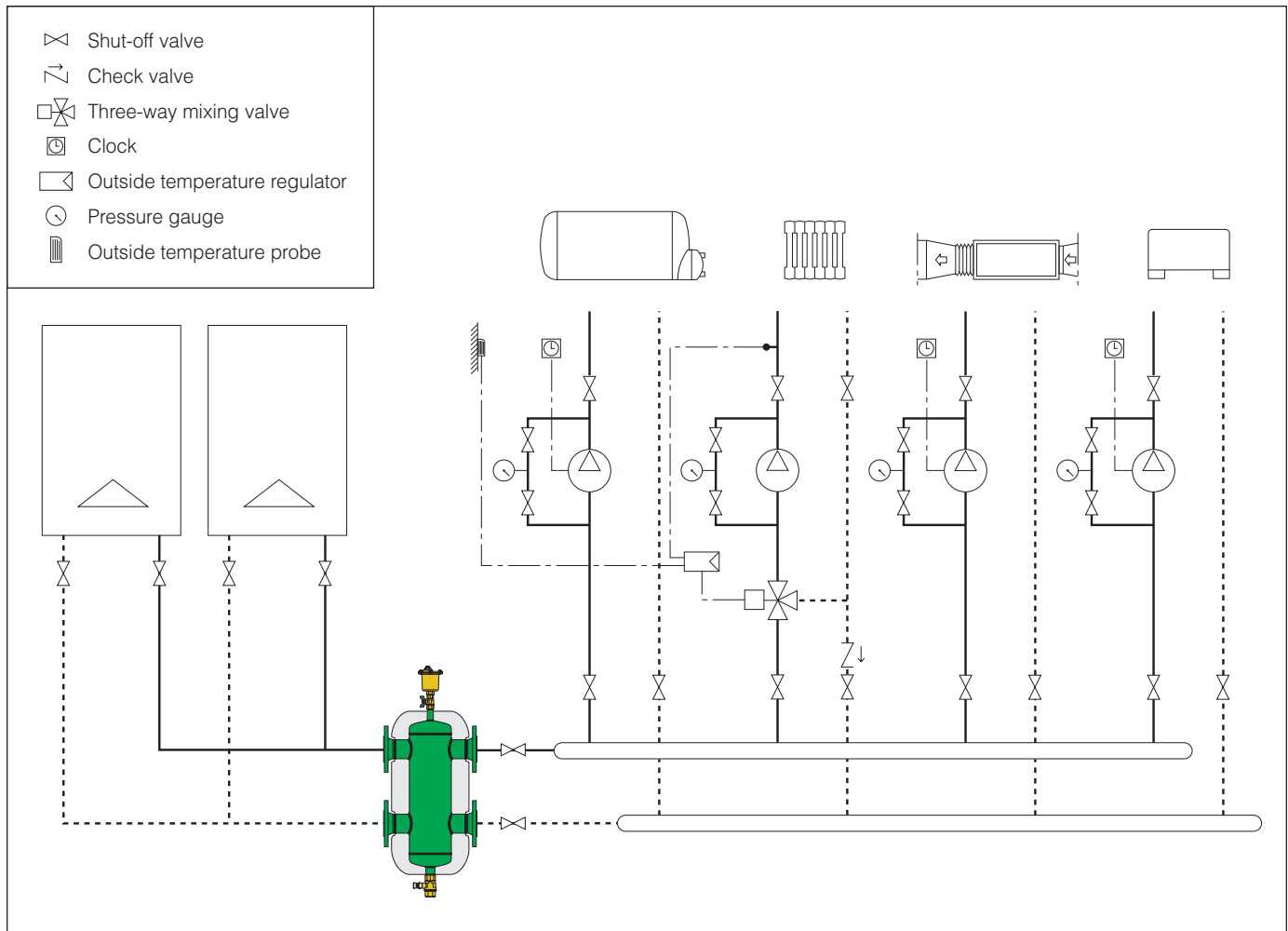

## SPECIFICATION SUMMARIES

### HydroCal™ 549 series

Combination hydraulic, air and dirt separator. ANSI B16.5 CLASS 150 RF flanged connections 2", 2-1/2", 3" and 4". Epoxy resin painted steel body. 300 series stainless steel internal coalescing mesh. Vessel working temperature range of 32–220°F (0–105°C) with insulation, 32–270°F (0–132°C) without insulation. Glycol maximum 50%. 100% air removal to microbubble level. Particle separation rating to 5 micron (0.2 mil). Max. connection velocity 4 feet per second (1.2 m/s). Max. working pressure 150 psi (10 bar). Supplied with: automatic air vent with 3/4" NPT female outlet connection and brass body. Brass body 3/4" NPT female shut-off ball valve for air vent. Drain ball valve brass body with 1-1/4" NPT female connection. Rigid closed cell expanded polyurethane foam shell insulation with external embossed aluminium cover for 2, 2-1/2, 3 and 4 inch sizes.

### HydroCal™ NA549 series

Combination hydraulic, air and dirt separator. ANSI B16.5 CLASS 150 RF flanged connections 2", 2-1/2", 3", 4", 6", 8", 10" and 12". Epoxy resin painted steel body. 300 series stainless steel internal coalescing mesh. Vessel working temperature range of 32–220°F (0–105°C) with insulation, 32–270°F (0–132°C) without insulation. Glycol maximum 50%. 100% air removal to microbubble level. Particle separation rating to 5 micron (0.2 mil). Max. connection velocity 4 feet per second (1.2 m/s). Max. working pressure 150 psi (10 bar). Supplied with: automatic air vent with 3/4" NPT female outlet connection and brass body. Brass body 3/4" NPT female shut-off ball valve for air vent. Drain ball valve brass body with 1-1/4" NPT female connection for separator sizes 2–6"; 2" NPT female connections for separator size 8–12". For separator size 8–12" only thermometer pocket well on front center 3/4" NPT female; and on inlet/outlet flanges 1/2" NPT female. Rigid closed cell expanded polyurethane foam shell insulation with external embossed aluminium cover for 2, 2-1/2, 3 and 4 inch sizes. The separator is designed and built in accordance Section VIII, Division 1 of the ASME Boiler and Pressure Vessel Code and tagged and registered with the National Board of Boiler and Pressure Vessel Inspector, and CRN registered, and stamped for 150 psi (10 bar) working pressure, with ASME U stamp.

We reserve the right to change our products and their relevant technical data, contained in this publication, at any time and without prior notice.



Caleffi North America, Inc.  
 3883 W. Milwaukee Road  
 Milwaukee, WI 53208  
 Tel: 414-238-2360 · Fax: 414-238-2366  
 sales@caleffi.com · www.caleffi.us  
 © Copyright 2014 Caleffi North America, Inc.