

**FAMCO**

QUALITY HVAC AND ROOFING SOLUTIONS SINCE 1989

## 2017 PRODUCT CATALOG

[FAMCOMFG.COM](http://FAMCOMFG.COM)

ROOF VENTS | WALL VENTS | GABLE VENTS | SOFFIT/FOUNDATION VENTS  
HVAC DAMPERS | CHIMNEY CAPS | PIPE FLASHINGS | HVAC ACCESSORIES | ROOF FLASHINGS  
ROOF EDGE FLASHINGS | VALLEY FLASHINGS | METAL SHINGLES



# RESIDENTIAL/COMMERCIAL SPLIT-SYSTEM ECONOMIZING DELIVERING FRESH AIR INDOORS

Airside economizing shouldn't just be good in theory. It should deliver what owners expect. With the ZIP Economizer, it does.

Airside economizing isn't just a great way to reduce operating costs; it is a requirement in most non-residential HVAC systems throughout the United States. Airside economizers also fulfill another important requirement for buildings by providing the correct ratio of outside air and return air to deliver proper indoor air quality (IAQ) to meet codes.

Unfortunately, having an economizer system doesn't necessarily mean you are accomplishing these goals. Studies have shown that up to 70% of economizers are not functioning properly. Many times economizer systems are set up incorrectly or are simply

left to operate in factory default mode. Even worse, because economizer failures generally do not result in comfort problems many failures go undetected! These problems persist, year after year, costing building owners unnecessary expense. Meanwhile, energy standards and building IAQ requirements are not being met.

Why does this happen? Because most economizers incorporate factory settings and confusing manuals that makes setting up, operating, and troubleshooting difficult.



**BELIMO**<sup>®</sup>

## Stay on Course with the ZIP Economizer

Until now, economizing solutions have left a lot of room for error. The ZIP gets efficiency strategies back on track with easy setup, automatic code change over temperatures, and superior troubleshooting capability. Users know instantly when failures occur and the ZIP helps them quickly pinpoint the problem and address it. With the following features, the ZIP leaves nothing to chance:

- 1 Easy-to-read Automotive Grade LCD Display. Extremely simple to navigate, this display delivers clear live status information, easy setup, changes, and operating history.
- 2 ZIP Code Patented Technology. By simply entering your US zip code, or Canadian postal code, the system will automatically recognize your climate zone and will set the high limit change over temperature providing automatic compliance.
- 3 Plug and Play. With its self-configuration, if it's not plugged into the economizer, you won't have to worry about setting it up.
- 4 Acceptance Tests. Integrated onboard test sequence that ensures effortless compliance with California Title 24, and verification of proper operation.
- 5 Fault Detection and Diagnostics (FDD). Troubleshoot faults, initiates alarms, and reconfigures for best operation.
- 6 Reliable Belimo damper actuator
- 7 Rugged, tight sealing pre-insulated damper box

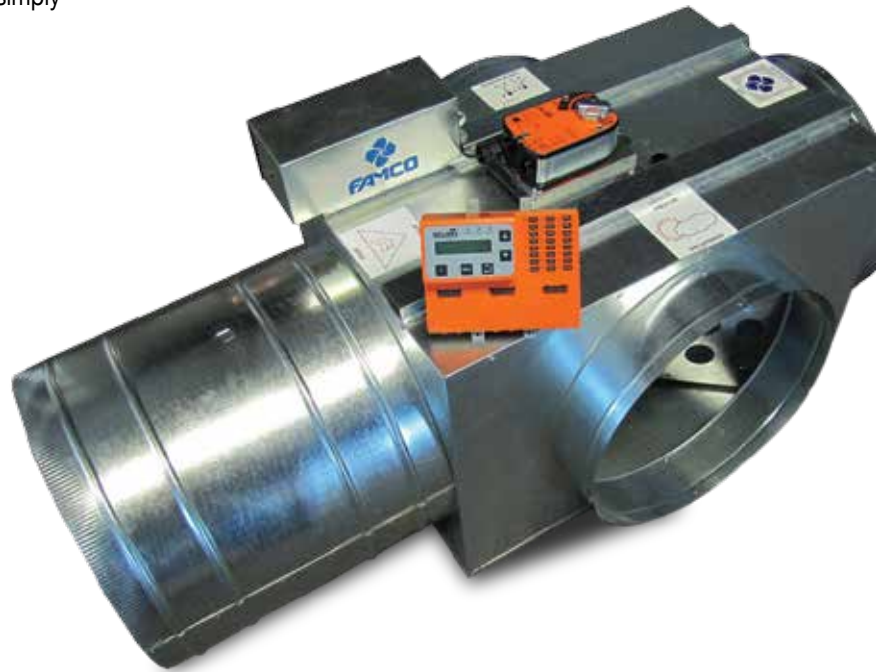



# CONTENTS / INDEX

## TERMS & CONDITIONS

Terms Of Sale .....	5
Delivery Terms .....	5
Ordering Information .....	5
Guarantee .....	6
Errors & Omissions .....	6
About Us .....	6
Return Policy .....	7
Freight Claims .....	7
Zone Map .....	8
Freight Allowances .....	8

## MAKE-UP AIR KITS

Air Kit .....	9
---------------	---

## ROOF VENTS

J-Vent .....	10
J-Vent With Shake Base .....	10
J-Vent With 6" Clearance .....	10
J-Vent With Extension .....	11
J-Vent Copper .....	11
Louvered Roof Vent - 50 Sq. In. Net Free Area .....	11
Plastic Roof Vent - 50 Sq. In. Net Free Area .....	11
Roof Vent With 38 Sq. In. Net Free Area .....	12
Peak Vent .....	12
Plastic Bathroom / Kitchen Exhaust Vent .....	12
Bathroom / Kitchen Exhaust Vent - Galvanized .....	13
Bathroom / Kitchen Exhaust Vent - Painted .....	13
Bathroom / Kitchen Exhaust Vent - Copper .....	14
Globe Vents .....	14

Round Vent Bases .....	15-16
Sub Base .....	16
Continuous Ridge Vent .....	16

## WALL VENTS

Rectangular Wall Vents .....	17
Hooded Wall Vents .....	18-20
Hooded Wall Vents With Reversible Damper .....	20
Stucco Ring For Wall Vents .....	21

## LOUVERED GABLE VENTS

Louvered Vent With Round Transition .....	22
Gable Vents .....	22
Gable Vents - Copper .....	23

## SOFFIT & FOUNDATION VENTS

Louvered Foundation & Soffit Vents .....	24
Continuous Soffit Vent .....	24
Plastic Under Eave Vents .....	25
Plastic Wall Vents .....	25

## HVAC DAMPERS

Motorized Dampers .....	26-27
Backdraft Dampers .....	27
Pressure Relief Dampers .....	28

## CHIMNEY CAPS & ADAPTERS

Wind Directional Caps .....	29
Wind Cap Adapters .....	29
Square Tile Adapters .....	29
Vacuum Caps .....	30
Square Base Vacuum Caps .....	31

Universal Caps .....	32
Cone Top Caps .....	32
Cone Top Caps - Copper .....	33
Universal Caps - Copper .....	33

## PIPE FLASHINGS

Pipe Flashings - Standard Pitch .....	34
Pipe Flashings - Steep Pitch .....	34
Pipe Flashings - Flat Pitch .....	35
Cricket Flashings .....	35
Pipe Flashings With Neoprene Collar .....	35

## HVAC ACCESSORIES

Flue Caps & Plugs .....	36
Tapered Reducer .....	36
Increaser / Reducer .....	37
Plug Reducer .....	37
Transition Box .....	38
Storm Collars .....	38
Vent Collars .....	39
Nail Plates .....	39
Vent Screen .....	39
Furnace Filter Rack .....	40

## JOIST POCKET LINERS

Joist Pocket Liner .....	41
--------------------------	----

## ROOFING METALS

Roof Edge .....	42-47
Roof Flashing .....	48-52
Shingles .....	53
Valley Metal .....	54-55

# TERMS & CONDITIONS

## TERMS OF SALE:

**DISCOUNTS:** Discounts offered by FAMCO are for approved accounts only. Discounts are a percentage off list price from list price book. All special orders are priced net and receive no discounts. FAMCO will not accept returns of special ordered products.

**TERMS:** Terms are NET 30 days from date of invoice. Payment to be made to FAMCO, 649 N. Ralstin St., Meridian, ID 83642. There will be an interest charge of 1½% per month (18% APR) added on all accounts over 30 days. FAMCO reserves the right to change prices without notice.

## DELIVERY TERMS:

**FREIGHT:** All orders should try to reach freight free minimums if possible. All orders below freight free minimums will be prepaid and added to invoice unless specified otherwise. See page 9 for freight allowances.

**ROUTING:** Orders will be shipped the most cost effective way. Any additional freight cost over standard routing will be invoiced to the customer. We cannot be liable for shipping delays not within our control.

## ORDERING INFORMATION:

**CATALOG:** Please use our catalog numbers and description when ordering to avoid confusion or delay.

**MATERIALS:** Please contact us for all special material requests.

**BIDS & QUOTES:** All price quotes are good for a maximum of 30 days unless stated otherwise in writing.

**MINIMUMS:** There will be a minimum order charge of \$35.00 for any order less than \$35.00 net.

**MISC:** Extra catalogs, price sheets, ad materials and samples will be provided at the option of FAMCO.

# TERMS & CONDITIONS

## GUARANTEE:

All products are guaranteed to be free of defective material or workmanship for a period of one year from date of delivery. During the guarantee period, if any parts prove defective, they will be repaired or replaced free of charge at factory option; if, upon receipt of written authorization they are delivered prepaid to the factory. This guarantee does not, however, cover any damage caused by neglect of lubrication, accident or overload, improper installation, nor does it cover the cost of repairs made or attempted outside the factory without written authorization from FAMCO. Correction of any verified defects by repair or replacement shall constitute fulfillment of the guarantee. Customer must pay all freight cost associated with repair or replacement.

## ERRORS & OMISSIONS:

While every effort has been made to ensure the accuracy of the information supplied herein, FAMCO (Fresh Air Manufacturing Company) cannot be held responsible for any errors or omissions.



## ABOUT US:

Established in 1989, FAMCO, headquartered in Meridian, Idaho, is one of the Pacific Northwest's largest manufacturers of Roof Flashings, Pipe Flashings, Ventilation Products, HVAC Accessories, Plastic Air Ventilation Products, and Specialty Building Products.

FAMCO currently manufactures and distributes from three plants located in Meridian, Nampa and Caldwell, Idaho to thousands of HVAC, Roofing and Building Material wholesalers across the United States and Canada. FAMCO builds high quality products that have been trusted by HVAC, Mechanical, Roofing, and Building Professionals for decades.

Our quality starts with using the finest raw materials available and having our experienced team following Lean Manufacturing principles. Under Lean Manufacturing, every procedure is measured, analyzed and checked for quality, efficiency and customer satisfaction. It is the veteran management team, industry knowledge and desire to always improve that separates FAMCO from the competition. We pride ourselves on the guarantee of quality Ventilation and Building Products.

# TERMS & CONDITIONS

## RETURN POLICY:

The customer is responsible for freight charges to return the product. There is a 25% restocking fee for all returned product. Credit will not be issued until product is returned and inspected. Product must arrive in resalable condition. Credits will expire 1 year from date of issue and will no longer be honored.

FAMCO will issue a Return Authorization (RA) for all returns and it must accompany the product. No return will be accepted without an RA. The RA's are good for a maximum of 30 days. If the product is not returned within that time frame a new RA must be requested.

For damaged product, FAMCO will need pictures of the damage to determine if we will need it returned for credit. An RA will be issued for the return.

## FREIGHT CLAIMS:

All claims must be reported to FAMCO within 2 weeks of delivery.

If product is missing or damaged in shipment, it must be noted on the delivery receipt (BOL) prior to the freight truck departure. If you do not have time to count while the driver is there, please note on the delivery receipt "**subject to count**". Without this information on the delivery receipt, we will no longer be able to issue a credit for missing products. It is the responsibility of the customer to file freight claims with the carrier.

# ZONE MAP

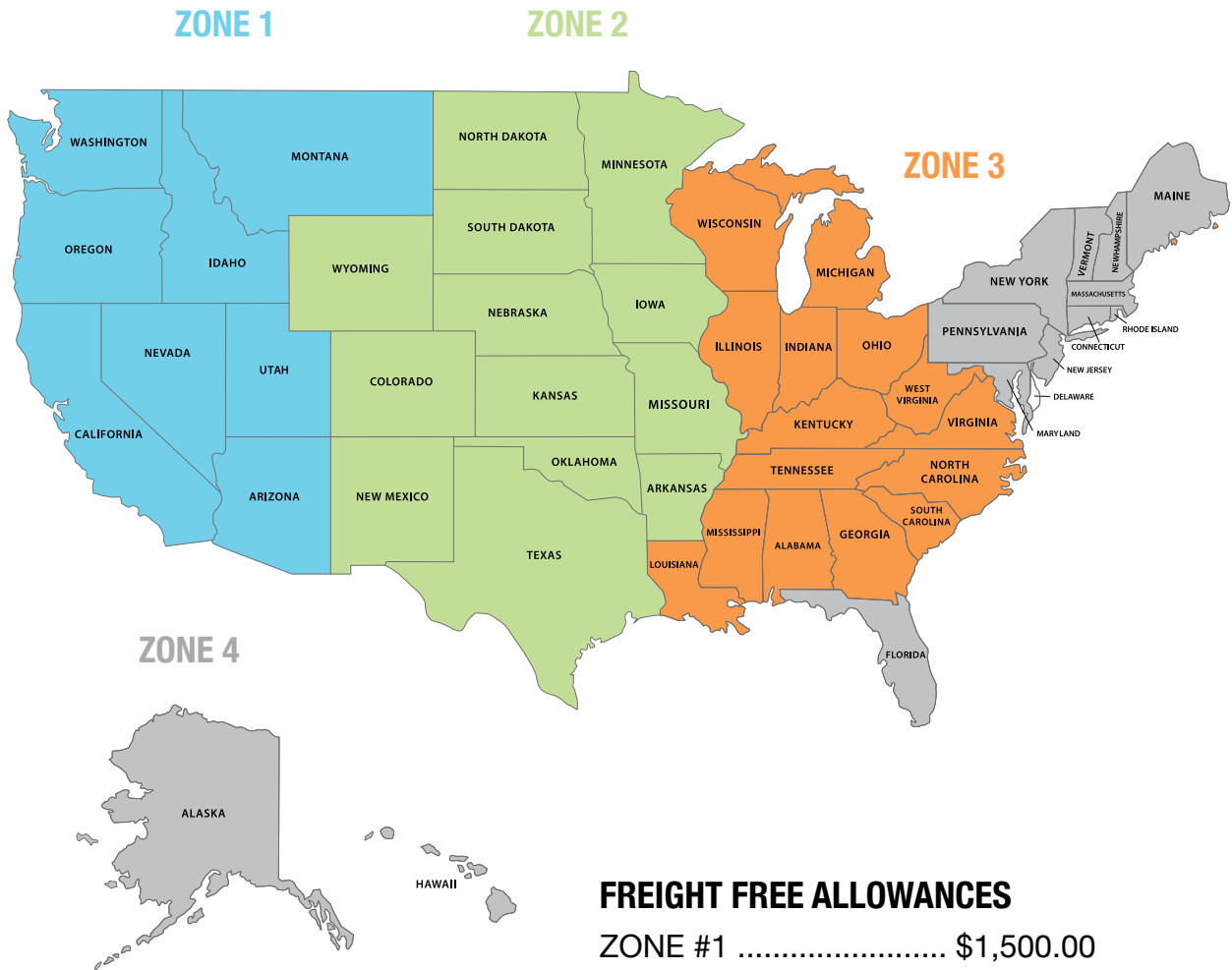

ZONE #4 - Includes:  
 AK, HI, ME, VT, NH,  
 MA, CT, RI, NY,  
 PA, NJ, DE, MD &  
 CANADA

## FREIGHT FREE ALLOWANCES

ZONE #1 .....	\$1,500.00
ZONE #2 .....	\$2,000.00
ZONE #3 .....	\$2,500.00
ZONE #4 .....	F.O.B. Meridian, ID

\*SOME RESTRICTIONS APPLY

\*EXCLUDES OVERSIZED PALLETS AND SPECIAL ORDERS



# MAKE-UP AIR KITS



Heavy Duty Switch

**MUHDS**

Sizes: 4", 6", 8", 10"



Adjustable Switch

**MUAS**

Sizes: 4", 6", 8", 10"



Universal Relay with Current Switch

**MUUS**

Sizes: 4", 6", 8", 10"



Pressure Sensor

**MUPSS**

Sizes: 4", 6", 8", 10"

# ROOF VENTS

## J-VENT

SIZE	MODEL #	CTN QTY	PAINTED	
3"	* JV3	N/A	JV3BR	JV3BK
4"	* JV4		JV4BR	JV4BK
6"	JV6		JV6BR	JV6BK
7"	JV7		JV7BR	JV7BK
8"	JV8		JV8BR	JV8BK
9"	JV9		JV9BR	JV9BK
10"	JV10		JV10BR	JV10BK
12"	JV12		JV12BR	JV12BK
14"	JV14		JV14BR	JV14BK

\* OTHER SIZES AVAILABLE, CALL FOR PRICING - \* 3" & 4" ONLY AVAILABLE WITH ONE-PIECE HOOD



**JV**

## J-VENT WITH SHAKE BASE

SIZE	MODEL #	CTN QTY	PAINTED	
3"	* JV3SB	N/A	JV3SBBR	JV3SBBK
4"	* JV4SB		JV4SBBR	JV4SBBK
6"	JV6SB		JV6SBBR	JV6SBBK
7"	JV7SB		JV7SBBR	JV7SBBK
8"	JV8SB		JV8SBBR	JV8SBBK

\* OTHER SIZES AVAILABLE, CALL FOR PRICING - \* 3" & 4" ONLY AVAILABLE WITH ONE-PIECE HOOD



**JVSB**

## J-VENT WITH 6" CLEARANCE

SIZE	MODEL #	CTN QTY	PAINTED	
3"	* JV3CL	N/A	JV3CLBR	JV3CLBK
4"	* JV4CL		JV4CLBR	JV4CLBK
6"	JV6CL		JV6CLBR	JV6CLBK
7"	JV7CL		JV7CLBR	JV7CLBK
8"	JV8CL		JV8CLBR	JV8CLBK

\* OTHER SIZES AVAILABLE, CALL FOR PRICING - \* 3" & 4" ONLY AVAILABLE WITH ONE-PIECE HOOD



**JVCL**

# ROOF VENTS



**JVX**

## J-VENT WITH EXTENSION

SIZE	MODEL #	CTN QTY	PAINTED	
3"	* JV3X	N/A	JV3XBR	JV3XBK
4"	* JV4X		JV4XBR	JV4XBK
6"	JV6X		JV6XBR	JV6XBK
7"	JV7X		JV7XBR	JV7XBK
8"	JV8X		JV8XBR	JV8XBK

\* 3" & 4" ONLY AVAILABLE WITH ONE-PIECE HOOD



**JVCU**

## COPPER J-VENT

SIZE	MODEL #	CTN QTY
3"	JV3CU	N/A
4"	JV4CU	
5"	JV5CU	
6"	JV6CU	
7"	JV7CU	
8"	JV8CU	
10"	JV10CU	
12"	JV12CU	



**LRV50**

## LOUVERED ROOF VENT WITH SLANT BACK

SIZE	MODEL #	COLOR	CTN QTY
50 Sq. In. Net Free Area	LRV50	GALVANIZED	8
	LRV50BK	BLACK	
	LRV50BR	BROWN	
	LRV50WH	WHITE	
	LRV50GR	GRAY	



**FA50**

## PLASTIC ROOF VENT WITH 50 SQ. IN. NET FREE AREA

SIZE	MODEL #	COLOR	CTN QTY
50 Sq. In. Net Free Area	FA50BK	BLACK	12
	FA50DBR	DARK BROWN	
	FA50WH	WHITE	
	FA50WG	WOOD GRAY	
	FA50GR	GRAY	

# ROOF VENTS

## ROOF VENT WITH 38 SQ. IN. NET FREE AREA

COLOR	MODEL #	CTN QTY
GALVANIZED	JV038	6
BROWN	JV038BR	
BLACK	JV038BK	
GRAY	JV038GR	
WHITE	JV038WH	



**JV038**

## COPPER ROOF VENT WITH 38 SQ. IN. NET FREE AREA

MATERIAL	MODEL #	CTN QTY
COPPER	JV038CU	N/A



**JV038CU**

## PEAK VENT

SIZE	MODEL #			CTN QTY
	GALVANIZED	ALUMINUM	PAINTED	
3"	PV3	PV3A	PV3P	N/A
4"	PV4	PV4A	PV4P	
5"	PV5	PV5A	PV5P	
7"	PV7	PV7A	PV7P	
8"	PV8	PV8A	PV8P	
10"	PV10	PV10A	PV10P	



**PV**

## PLASTIC BATHROOM / KITCHEN EXHAUST VENT WITH SCREEN & DAMPER & REMOVABLE STEM

SIZE	MODEL #	COLOR	CTN QTY
4"	BVDS4WH	WHITE	12
	BVDS4GR	GRAY	
	BVDS4WG	WOOD GRAY	
	BVDS4BK	BLACK	
	BVDS4DBR	DARK BROWN	
6"	BVDS6WH	WHITE	12
	BVDS6GR	GRAY	
	BVDS6WG	WOOD GRAY	
	BVDS6BK	BLACK	
	BVDS6DBR	DARK BROWN	



**BVDS**

# ROOF VENTS



**BK**

## BATHROOM / KITCHEN EXHAUST VENT WITH SCREEN & DAMPER - GALVANIZED

MATERIAL	SIZE	MODEL #	CTN QTY	MODEL #	CTN QTY
WITHOUT BOTTOM EXTENSION			WITH BOTTOM EXTENSION		
GALVANIZED	4"	BK4	N/A	BK4X	N/A
	6"	BK6		BK6X	
	8"	BK8		BK8X	
	10"	BK10		BK10X	



**BKX**

## BATHROOM / KITCHEN EXHAUST VENT WITH SCREEN & DAMPER - PAINTED

MATERIAL	SIZE	MODEL #	CTN QTY	MODEL #	CTN QTY
WITHOUT BOTTOM EXTENSION			WITH BOTTOM EXTENSION		
BLACK	4"	BK4BK	N/A	BK4XBK	N/A
	6"	BK6BK		BK6XBK	
	8"	BK8BK		BK8XBK	
	10"	BK10BK		BK10XBK	
BROWN	4"	BK4BR	N/A	BK4XBR	N/A
	6"	BK6BR		BK6XBR	
	8"	BK8BR		BK8XBR	
	10"	BK10BR		BK10XBR	

# ROOF VENTS

## BATHROOM / KITCHEN EXHAUST VENT WITH SCREEN & DAMPER - COPPER

SIZE	MODEL #	CTN QTY	SIZE	MODEL #	CTN QTY
WITHOUT BOTTOM EXTENSION			WITH BOTTOM EXTENSION		
4"	BK4CU	N/A	4"	BK4XCU	N/A
6"	BK6CU		6"	BK6XCU	
8"	BK8CU		8"	BK8XCU	
10"	BK10CU		10"	BK10XCU	



**BKCU**

## GLOBE VENT

SIZE	MODEL #	CTN QTY	SIZE	MODEL #	CTN QTY
GALVANIZED			STAINLESS STEEL		
3"	GBV3	N/A	4"	GBV4SS	N/A
4"	GBV4		6"	GBV6SS	
5"	GBV5		7"	GBV7SS	
6"	GBV6		8"	GBV8SS	
7"	GBV7		10"	GBV10SS	
8"	GBV8		12"	GBV12SS	
9"	GBV9				
10"	GBV10				
12"	GBV12				
14"	GBV14				
16"	GBV16				
18"	GBV18				
20"	GBV20				
22"	GBV22				
24"	GBV24				
30"	GBV30				
34"	GBV34				
36"	GBV36				



**GBV**



# ROOF VENTS



**FB**

## ROUND VENT BASE - FLAT

SIZE	MODEL #	CTN QTY
4"	FB4	N/A
6"	FB6	
8"	FB8	
10"	FB10	
12"	FB12	
14"	FB14	
16"	FB16	
18"	FB18	
20"	FB20	
22"	FB22	
24"	FB24	

\* LARGER SIZES AVAILABLE, CALL FOR DETAILS.



**PB**

## ROUND VENT BASE - PITCHED

SIZE	MODEL #	CTN QTY
4"	PB4	N/A
6"	PB6	
8"	PB8	
10"	PB10	
12"	PB12	
14"	PB14	
16"	PB16	
18"	PB18	
20"	PB20	
22"	PB22	
24"	PB24	

\* PLEASE SPECIFY ROOF PITCH WHEN ORDERING

# ROOF VENTS

## ROUND VENT BASE - SADDLE

SIZE	MODEL #	CTN QTY
4"	SB4	N/A
6"	SB6	
8"	SB8	
10"	SB10	
12"	SB12	
14"	SB14	
16"	SB16	
18"	SB18	
20"	SB20	
22"	SB22	
24"	SB24	



**SB**

\* PLEASE SPECIFY ROOF PITCH WHEN ORDERING

## SUB BASE

SIZE	MODEL #	CTN QTY
3¾"	FB3.75	N/A
7¾"	FB7.75	
9¾"	FB9.75	
11¾"	FB11.75	



**SUB BASE**

## CONTINUOUS RIDGE VENT

SIZE	COLOR	MODEL #	CTN QTY
4"	GALVANIZED	CRV4	40 LF
8"		CRV8	20 LF
PAINTED			
4"	BLACK	CRV4BK	40 LF
	WHITE	CRV4WH	
	BROWN	CRV4BR	
8"	BLACK	CRV8BK	20 LF
	WHITE	CRV8WH	
	BROWN	CRV8BR	



**CRV**

\* ALL CRV MADE IN 10' PIECES

# WALL VENTS



**WV310**

## 3 1/4" x 10" - HOODED RECTANGULAR WALL VENT WITH DAMPER

MATERIAL	W/ SCREEN	CTN QTY	DAMPER ONLY	CTN QTY
GALVANIZED	WV310S	N/A	WV310	N/A
ALUMINUM	WV310SA		WV310A	
BLACK	WV310SBK		WV310BK	
BROWN	WV310SBR		WV310BR	
WHITE	WV310SWH		WV310WH	



**WV310CU**

## 3 1/4" x 10" COPPER- HOODED RECTANGULAR WALL VENT WITH DAMPER

MATERIAL	MODEL #	CTN QTY
COPPER	WV310CU - DAMPER ONLY	N/A
COPPER	WV310SCU - DAMPER & SCREEN	



**WV310HDBK**

## 3 1/4" x 10" - HEAVY DUTY HOODED RECTANGULAR WALL VENT WITH DAMPER & SCREEN

MATERIAL	MODEL #	CTN QTY
24 GA. BLACK POWDER COAT	WV310HDBK	N/A

# WALL VENTS

## HOODED WALL VENT - ALUMINUM

SIZE	WITH DAMPER	WITH SCREEN	CTN QTY	DAMPER & SCREEN	CTN QTY
3"	DWV3A	SWV3A	N/A	SDWV3A	N/A
4"	DWV4A	SWV4A		SDWV4A	
5"	DWV5A	SWV5A		SDWV5A	
6"	DWV6A	SWV6A		SDWV6A	
7"	DWV7A	SWV7A		SDWV7A	
8"	DWV8A	SWV8A		SDWV8A	
10"	DWV10A	SWV10A		SDWV10A	
12"	DWV12A	SWV12A		SDWV12A	



**WVA**

## HOODED WALL VENT - GALVANIZED

SIZE	WITH DAMPER	WITH SCREEN	CTN QTY	DAMPER & SCREEN	CTN QTY
3"	DWV3	SWV3	N/A	SDWV3	N/A
4"	DWV4	SWV4		SDWV4	
5"	DWV5	SWV5		SDWV5	
6"	DWV6	SWV6		SDWV6	
7"	DWV7	SWV7		SDWV7	
8"	DWV8	SWV8		SDWV8	
10"	DWV10	SWV10		SDWV10	
12"	DWV12	SWV12		SDWV12	
14"	DWV14	SWV14	SDWV14		



**WV**

# WALL VENTS



**WVP**

## HOODED WALL VENT - PAINTED

SIZE	WITH DAMPER	WITH SCREEN	CTN QTY	DAMPER & SCREEN	CTN QTY
3"	DWV3P	SWV3	N/A	SDWV3P	N/A
4"	DWV4P	SWV4P		SDWV4P	
5"	DWV5P	SWV5P		SDWV5P	
6"	DWV6P	SWV6P		SDWV6P	
7"	DWV7P	SWV7P		SDWV7P	
8"	DWV8P	SWV8P		SDWV8P	
10"	DWV10P	SWV10P		SDWV10P	
12"	DWV12P	SWV12P		SDWV12P	
14"	DWV14P	SWV14P		SDWV14P	



**WVE**

## HOODED WALL VENT WITH SPRING LOADED DAMPER, GASKET, SCREEN & SHORT TUBE

SIZE	GALVANIZED	ALUMINUM	CTN QTY	PAINTED	CTN QTY
4"	WVE4	WVE4A	N/A	WVE4P	N/A



**WVCU**

## COPPER HOODED WALL VENTS

SIZE	WITH DAMPER	WITH SCREEN	CTN QTY	DAMPER & SCREEN	CTN QTY
3"	DWV3CU	SWV3CU	N/A	SDWV3CU	N/A
4"	DWV4CU	SWV4CU		SDWV4CU	
5"	DWV5CU	SWV5CU		SDWV5CU	
6"	DWV6CU	SWV6CU		SDWV6CU	
7"	DWV7CU	SWV7CU		SDWV7CU	
8"	DWV8CU	SWV8CU		SDWV8CU	
10"	DWV10CU	SWV10CU		SDWV10CU	
12"	DWV12CU	SWV12CU		SDWV12CU	

# WALL VENTS

## HOODED WALL VENT WITH SCREEN & REVERSIBLE BACKDRAFT DAMPER

SIZE	GALVANIZED	ALUMINUM	CTN QTY
4"	RDWV4	RDWV4A	N/A
5"	RDWV5	RDWV5A	
6"	RDWV6	RDWV6A	
7"	RDWV7	RDWV7A	
8"	RDWV8	RDWV8A	
10"	RDWV10	RDWV10A	
12"	RDWV12	RDWV12A	



**RDWV**

## HOODED WALL VENT WITH SPRING LOADED DAMPER, GASKET & SCREEN

SIZE	GALVANIZED	ALUMINUM	CTN QTY	PAINTED	CTN QTY
3"	WVEB3	WVEB3A	N/A	WVEB3P	N/A
4"	WVEB4	WVEB4A		WVEB4P	
5"	WVEB5	WVEB5A		WVEB5P	
6"	WVEB6	WVEB6A		WVEB6P	
7"	WVEB7	WVEB7A		WVEB7P	
8"	WVEB8	WVEB8A		WVEB8P	
10"	WVEB10	WVEB10A		WVEB10P	



**WVEB**

## HEAVY DUTY HOODED WALL VENT WITH SPRING LOADED DAMPER, GASKET, SCREEN & SHORT TUBE

SIZE	MATERIAL	MODEL #	CTN QTY
6"	24 GA. BLACK POWDER COAT	WVEBH6BK	N/A



**WVEBH**



# WALL VENTS



**SR**

## STUCCO TRIM RING FOR WALL VENTS

SIZE	MODEL #	CTN QTY
3"	SR3	N/A
4"	SR4	
5"	SR5	
6"	SR6	
7"	SR7	
8"	SR8	
10"	SR10	
12"	SR12	

# LOUVERED GABLE VENTS

## LOUVERED VENT WITH ROUND TRANSITION

SQUARE TO ROUND	MODEL #	CTN QTY
8" X 8" TO 6" ROUND	GVT886	N/A
8" X 8" TO 8" ROUND	GVT888	
12" X 8" TO 6" ROUND	GVT1286	
12" X 8" TO 8" ROUND	GVT1288	
12" X 10" TO 8" ROUND	GVT12108	
12" X 10" TO 10" ROUND	GVT121010	
12" X 12" TO 8" ROUND	GVT12128	
12" X 12" TO 10" ROUND	GVT121210	
12" X 12" TO 12" ROUND	GVT121212	



**GVT**

\* ALL GVT UNITS COME WITH 1/8" SCREEN  
 \* OTHER SIZES AVAILABLE, CALL FOR PRICING

## LOUVERED GABLE VENT

SIZE	MODEL #	CTN QTY
<b>WIDTH x HEIGHT</b>	<b>R - RECESSED MOUNT, 3/4" BACK FROM FRONT</b>	
12" x 12"	GV1212R	N/A
12" x 18"	GV1218R	
14" x 18"	GV1418R	
14" x 24"	GV1424R	
<b>WIDTH x HEIGHT</b>	<b>F - FLUSH MOUNT, FLANGE ON FRONT</b>	
12" x 12"	GV1212F	N/A
12" x 18"	GV1218F	
14" x 18"	GV1418F	
14" x 24"	GV1424F	
<b>WIDTH x HEIGHT</b>	<b>FOB - FLANGE ON BACK</b>	
12" x 12"	GV1212FOB	N/A
12" x 18"	GV1218FOB	
14" x 18"	GV1418FOB	
14" x 24"	GV1424FOB	



**GV**

\* ALL GV UNITS COME WITH 1/8" SCREEN  
 \* OTHER SIZES AVAILABLE, CALL FOR PRICING

# LOUVERED GABLE VENTS



**GVCU**

## COPPER LOUVERED GABLE VENT

SIZE	MODEL #	CTN QTY
<b>WIDTH x HEIGHT</b>	AVAILABLE IN RECESSED MOUNT - FLUSH MOUNT & FLANGE ON BACK	
12" x 12"	GV1212CU	N/A
12" x 18"	GV1218CU	
14" x 18"	GV1418CU	
14" x 24"	GV1424CU	

\* OTHER SIZES AVAILABLE, CALL FOR PRICING

# SOFFIT & FOUNDATION VENTS

## LOUVERED FOUNDATION & SOFFIT VENT

SIZE	GALVANIZED	ALUMINUM	CTN QTY
<b>WIDTH x HEIGHT</b>	<b>WITH DAMPER</b>		
16" x 4"	VD416	VD416A	N/A
16" x 6"	VD616	VD616A	
16" x 8"	VD816	VD816A	
<b>WIDTH x HEIGHT</b>	<b>WITH SCREEN</b>		
16" x 4"	VS416	VS416A	N/A
16" x 6"	VS616	VS616A	
16" x 8"	VS816	VS816A	
<b>WIDTH x HEIGHT</b>	<b>WITH DAMPER &amp; SCREEN</b>		
16" x 4"	VDS416	VDS416A	N/A
16" x 6"	VDS616	VDS616A	
16" x 8"	VDS816	VDS816A	
<b>WIDTH x HEIGHT</b>	<b>WITHOUT DAMPER &amp; SCREEN</b>		
16" x 4"	V416	V416A	N/A
16" x 6"	V616	V616A	
16" x 8"	V816	V816A	



**VD**

## CONTINUOUS SOFFIT VENT

SIZE	MATERIAL	MODEL # (10' LENGTHS)	CTN QTY
4"	GALVANIZED	CSV4	N/A
	BROWN	CSV4BR	
	WHITE	CSV4WH	
	ALUMINUM	CSV4A	
	BLACK	CSV4BK	
6"	GALVANIZED	CSV6	
	BROWN	CSV6BR	
	WHITE	CSV6WH	
	ALUMINUM	CSV6A	
	BLACK	CSV6BK	
8"	GALVANIZED	CSV8	
	BROWN	CSV8BR	
	WHITE	CSV8WH	
	ALUMINUM	CSV8A	
	BLACK	CSV8BK	



**CSV**

\* ALSO AVAILABLE IN 4' LENGTHS

# PLASTIC VENTS

## UNDER EAWE VENT

SIZE	COLOR	MODEL #	CTN QTY
4" *DAMPER INCLUDED	WHITE	UEVD4WH	12
	BEIGE	UEVD4BG	
	BROWN	UEVD4BR	
6"	WHITE	UEV6WH	6
	BROWN	UEV6BR	
3" - 4" REDUCER	WHITE	UEV34RWH	N/A



**UEV**



**UEV34**



**VG4**

## REMOVABLE VENT GUARD

SIZE	WHITE ITEM #	BROWN ITEM #	CTN QTY
4"	VG4WH	VG4BR	N/A

\* ONLY COMPATIBLE WITH THE FAMCO LH4

## PLASTIC WALL VENTS

SIZE	WHITE ITEM #	BROWN ITEM #	CTN QTY
WITH MOVABLE LOUVERS			
3"	LH3WH	LH3BR	16
4"	LH4WH	LH4BR	12
5"	LH5WH	LH5BR	8
6"	LH6WH	LH6BR	12
7"	LH7WH	LH7BR	8
8"	LH8WH	LH8BR	12
WITH FIXED LOUVERS			
4"	AI4WH	AI4BR	12
6"	AI6WH	AI6BR	12
8"	AI8WH	AI8BR	8

\* SOLD BY CARTON QTY ONLY



**LH**



**AI**

# HVAC DAMPERS

## MOTORIZED DAMPER - POWER OPEN OR CLOSE WITH SPRING RETURN

SIZE	NORMALLY OPEN	NORMALLY CLOSED	CTN QTY
4"	ADO424	ADC424	N/A
	ADO424ES	ADC424ES	
	ADO4120	ADC4120	
	ADO4120ES	ADC4120ES	
5"	ADO524	ADC524	
	ADO524ES	ADC524ES	
	ADO5120	ADC5120	
	ADO5120ES	ADC5120ES	
6"	ADO624	ADC624	
	ADO624ES	ADC624ES	
	ADO6120	ADC6120	
	ADO6120ES	ADC6120ES	
7"	ADO724	ADC724	
	ADO724ES	ADC724ES	
	ADO7120	ADC7120	
	ADO7120ES	ADC7120ES	
8"	ADO824	ADC824	
	ADO824ES	ADC824ES	
	ADO8120	ADC8120	
	ADO8120ES	ADC8120ES	
10"	ADO1024	ADC1024	
	ADO1024ES	ADC1024ES	
	ADO10120	ADC10120	
	ADO10120ES	ADC10120ES	
12"	ADO1224	ADC1224	
	ADO1224ES	ADC1224ES	
	ADO12120	ADC12120	
	ADO12120ES	ADC12120ES	
14"	ADO1424	ADC1424	
	ADO1424ES	ADC1424ES	
	ADO14120	ADC14120	
	ADO41120ES	ADC41120ES	



**ADO**



**ADC**

\* ES = END SWITCH, 24 = 24 VOLT, 120 = 120 VOLT



# HVAC DAMPERS



**ADHD**

## HEAVY DUTY MOTORIZED DAMPER

SIZE	HEAVY DUTY MOTORIZED DAMPER WITH TMCB24-3-T MOTOR
6"	ADHD6TMCB243T
8"	ADHD8TMCB243T
10"	ADHD10TMCB243T
12"	ADHD12TMCB243T
14"	ADHD14TMCB243T
16"	ADHD16TMCB243T
18"	ADHD18TMCB243T
20"	ADHD20TMCB243T
22"	ADHD22TMCB243T



**BD**

## BACKDRAFT DAMPER

SIZE	DAMPER MODEL #	CTN QTY
4"	BD4	N/A
5"	BD5	
6"	BD6	
7"	BD7	
8"	BD8	
9"	BD9	
10"	BD10	
12"	BD12	
14"	BD14	
16"	BD16	
18"	BD18	
20"	BD20	

# HVAC DAMPERS

## PRESSURE RELIEF DAMPER

SIZE	MODEL #	CTN QTY
6"	PRD6	N/A
7"	PRD7	
8"	PRD8	
10"	PRD10	
12"	PRD12	
14"	PRD14	
16"	PRD16	
18"	PRD18	



**PRD**

# CHIMNEY CAPS



**WDC**

## WIND DIRECTIONAL CAP

SIZE	MODEL #	CTN QTY	SIZE	MODEL #	CTN QTY
GALVANIZED			STAINLESS STEEL		
5"	WDC5	N/A	5"	WDC5SS	N/A
6"	WDC6		6"	WDC6SS	
7"	WDC7		7"	WDC7SS	
8"	WDC8		8"	WDC8SS	
9"	WDC9		9"	WDC9SS	
10"	WDC10		10"	WDC10SS	
12"	WDC12		12"	WDC12SS	
14"	WDC14		14"	WDC14SS	



**WCASS**

## WIND CAP ADAPTER - STAINLESS STEEL

SIZE	MODEL #	CTN QTY
5"	WCA5SS	N/A
6"	WCA6SS	
7"	WCA7SS	
8"	WCA8SS	
9"	WCA9SS	
10"	WCA10SS	
12"	WCA12SS	
14"	WCA14SS	



**ATA**

## SQUARE TILE CAP ADAPTER

SIZE	MODEL #	CTN QTY	SIZE	MODEL #	CTN QTY
GALVANIZED			STAINLESS STEEL		
8"x8"	ATA88	N/A	8"x8"	ATA88SS	N/A
8"x12"	ATA812		8"x12"	ATA812SS	
12"x12"	ATA1212		12"x12"	ATA1212SS	
12"x16"	ATA1216		12"x16"	ATA1216SS	
16"x16"	ATA1616		16"x16"	ATA1616SS	

\* CALL TO ORDER, SPECIAL MEASUREMENTS REQUIRED, OTHER SIZES AVAILABLE  
 \* MAX PERIMETER MEASUREMENT 64"

# CHIMNEY CAPS

## VACUUM CAP

SIZE	MODEL #	CTN QTY	SIZE	MODEL #	CTN QTY
GALVANIZED			ALUMINUM		
3"	VC3	N/A	3"	VC3A	N/A
4"	VC4		4"	VC4A	
5"	VC5		5"	VC5A	
6"	VC6		6"	VC6A	
7"	VC7		7"	VC7A	
8"	VC8		8"	VC8A	
9"	VC9		9"	VC9A	
10"	VC10		10"	VC10A	
12"	VC12		12"	VC12A	
14"	VC14		N/A	N/A	
16"	VC16		N/A	N/A	
STAINLESS STEEL			ROUND BASE		
3"	VC3SS	N/A	3"	VC3CU	N/A
4"	VC4SS		4"	VC4CU	
5"	VC5SS		5"	VC5CU	
6"	VC6SS		6"	VC6CU	
7"	VC7SS		7"	VC7CU	
8"	VC8SS		8"	VC8CU	
9"	VC9SS		9"	VC9CU	
10"	VC10SS		10"	VC10CU	
12"	VC12SS		12"	VC12CU	



**VC**



**VCCU**

# CHIMNEY CAPS



**SQ**

## SQUARE BASE VACUUM CAP

SIZE	MODEL #	CTN QTY	SIZE	MODEL #	CTN QTY
GALVANIZED			STAINLESS STEEL		
8" x 8"	SQ88	N/A	8" x 8"	SQ88SS	N/A
8" x 12"	SQ812		8" x 12"	SQ812SS	
8" x 16"	SQ816		8" x 16"	SQ816SS	
12" x 12"	SQ1212		12" x 12"	SQ1212SS	
12" x 16"	SQ1216		12" x 16"	SQ1216SS	



**SQCU**

## COPPER VACUUM CAP

SIZE	MODEL #	CTN QTY	SIZE	MODEL #	CTN QTY
SQUARE BASE			ROUND BASE		
8" x 8"	SQ88CU	N/A	3"	VC3CU	N/A
8" x 12"	SQ812CU		4"	VC4CU	
8" x 16"	SQ816CU		5"	VC5CU	
12" x 12"	SQ1212CU		6"	VC6CU	
12" x 16"	SQ1216CU		7"	VC7CU	
		8"	VC8CU		
		10"	VC10CU		
		12"	VC12CU		



**VCCU**

# CHIMNEY CAPS

## UNIVERSAL CAP

SIZE	MODEL #	CTN QTY	SIZE	MODEL #	CTN QTY
GALVANIZED			STAINLESS STEEL		
6"	UC6	N/A	6"	UC6SS	N/A
7"	UC7		7"	UC7SS	
8"	UC8		8"	UC8SS	



**UC**

## CONE TOP CAP

SIZE	MODEL #	CTN QTY	SIZE	MODEL #	CTN QTY
GALVANIZED			STAINLESS STEEL		
3"	CT3	N/A	3"	CT3SS	N/A
4"	CT4		4"	CT4SS	
5"	CT5		5"	CT5SS	
6"	CT6		6"	CT6SS	
7"	CT7		7"	CT7SS	
8"	CT8		8"	CT8SS	
9"	CT9		9"	CT9SS	
10"	CT10		10"	CT10SS	
12"	CT12		12"	CT12SS	
14"	CT14		N/A	N/A	
16"	CT16		N/A	N/A	



**CT**

# CHIMNEY CAPS



**CTCU**

## COPPER CONE TOP CAP

SIZE	MODEL #	CTN QTY
WITHOUT SCREEN		
3"	CT3CU	N/A
4"	CT4CU	
5"	CT5CU	
6"	CT6CU	
7"	CT7CU	
8"	CT8CU	
9"	CT9CU	
10"	CT10CU	
12"	CT12CU	



**UCCU**

## COPPER UNIVERSAL CHIMNEY CAP

SIZE	MODEL #	CTN QTY
6"	UC6CU	N/A
7"	UC7CU	
8"	UC8CU	

# PIPE FLASHING

## PIPE FLASHING - STANDARD PITCH (1/12 - 6/12)

SIZE	MODEL #	SIZE	DOUBLE WALL PIPE	CTN QTY
1"	G1	N/A	N/A	N/A
1.5"	G1.5			
2"	G2			
2.5"	G2.5			
3"	G3	3 5/8"	GB3	
4"	G4	4 5/8"	GB4	
5"	G5	5 5/8"	GB5	
6"	G6	6 5/8"	GB6	
7"	G7	7 5/8"	GB7	
8"	G8	8 5/8"	GB8	
9"	G9	9 5/8"	GB9	
10"	G10	11"	GB10	
12"	G12	13"	GB12	
14"	G14	15"	GB14	
16"	G16			
18"	G18			
20"	G20			



**G**

\* LARGER SIZES AVAILABLE, CONTACT US FOR DETAILS.

## PIPE FLASHING - STEEP PITCH (7/12 - 12/12)

SIZE	MODEL #	SIZE	DOUBLE WALL PIPE	CTN QTY
2"	GH2	N/A	N/A	N/A
3"	GH3	3 5/8"	GHB3	
4"	GH4	4 5/8"	GHB4	
5"	GH5	5 5/8"	GHB5	
6"	GH6	6 5/8"	GHB6	
7"	GH7	7 5/8"	GHB7	
8"	GH8	8 5/8"	GHB8	
9"	GH9	9 5/8"	GHB9	
10"	GH10	11"	GHB10	
12"	GH12	13"	GHB12	
14"	GH14	15"	GHB14	



**GH**

\* LARGER SIZES AVAILABLE



# PIPE FLASHING



**FP**



**TFP**



**CF**



**GBN**



**GB31N**

## FLAT PITCH PIPE FLASHING

SIZE	MODEL #	CTN QTY	SIZE	MODEL #	CTN QTY
STANDARD			12" TALL		
1"	FP1	N/A	1"	TFP1	N/A
2"	FP2		2"	TFP2	
3"	FP3		3"	TFP3	
4"	FP4		4"	TFP4	
5"	FP5		5"	TFP5	
6"	FP6		6"	TFP6	
7"	FP7		7"	TFP7	
8"	FP8		8"	TFP8	
9"	FP9		9"	TFP9	
10"	FP10		10"	TFP10	
12"	FP12		12"	TFP12	
14"	FP14		14"	TFP14	
16"	FP16		16"	TFP16	
18"	FP18		18"	TFP18	

## CRICKET FLASHING

SIZE	MODEL #	CTN QTY
1 1/2" & 2"	CF2	N/A
3" & 4"	CF4	

## PIPE FLASHING WITH NEOPRENE COLLAR

SIZE	MODEL #	CTN QTY	COLOR	MODEL #	CTN QTY
NEOPRENE COLLAR ADJUSTABLE FROM 3" - 1"			NEOPRENE COLLAR ADJUSTABLE FROM 3" - 4"		
GALVANIZED	GB31N	20	GALVANIZED	GB34N	20
BLACK			BLACK		
BROWN			BROWN		
GRAY			GRAY		
GALVANIZED BASE WITH NEOPRENE COLLAR					
1"	GB1N	20			
2"	GB2N				
3"	GB3N				
4"	GB4N				

# HVAC ACCESSORIES

## FLUE CAP & PLUG

SIZE	CAP MODEL #	PLUG MODEL #	CAP MODEL #	PLUG MODEL #	CTN QTY
GALVANIZED		ALUMINUM			N/A
3"	FC3	GP3	FC3A	GP3A	
4"	FC4	GP4	FC4A	GP4A	
5"	FC5	GP5	FC5A	GP5A	
6"	FC6	GP6	FC6A	GP6A	
7"	FC7	GP7	FC7A	GP7A	
8"	FC8	GP8	FC8A	GP8A	
9"	FC9	GP9	FC9A	GP9A	
10"	FC10	GP10	FC10A	GP10A	
12"	FC12	GP12	FC12A	GP12A	
14"	FC14	GP14	FC14A	GP14A	
16"	FC16	GP16	FC16A	GP16A	



**FC**



**GP**

## TAPERED REDUCER

SIZE	MODEL #	CTN QTY
GALVANIZED		N/A
4"x __	TR4 x __	
5"x __	TR5 x __	
6"x __	TR6 x __	
7"x __	TR7 x __	
8"x __	TR8 x __	
9"x __	TR9 x __	
10"x __	TR10 x __	
12"x __	TR12 x __	
14"x __	TR14 x __	
16"x __	TR16 x __	
18"x __	TR18 x __	
20"x __	TR20 x __	
22"x __	TR22 x __	
24"x __	TR24 x __	



**TR**

\* SECOND DIMENSION REQUIRED

# HVAC ACCESSORIES



**IR**

## INCREASER / REDUCER

SIZE	MODEL #	CTN QTY	SIZE	MODEL #	CTN QTY
GALVANIZED			ALUMINUM		
4" x __	IR4 x __	N/A	4" x __	IR4 __ A	N/A
5" x __	IR5 x __		5" x __	IR5 __ A	
6" x __	IR6 x __		6" x __	IR6 __ A	
7" x __	IR7 x __		7" x __	IR7 __ A	
8" x __	IR8 x __		8" x __	IR8 __ A	
9" x __	IR9 x __		9" x __	IR9 __ A	
10" x __	IR10 x __		10" x __	IR10 __ A	
12" x __	IR12 x __		12" x __	IR12 __ A	
14" x __	IR14 x __		N/A	N/A	
16" x __	IR16 x __				

\* SECOND DIMENSION REQUIRED



**PR**

## PLUG REDUCER

SIZE	MODEL #	CTN QTY
GALVANIZED		
4"x __	PR4 x __	N/A
5"x __	PR5 x __	
6"x __	PR6 x __	
7"x __	PR7 x __	
8"x __	PR8 x __	
9"x __	PR9 x __	
10"x __	PR10 x __	
12"x __	PR12 x __	
14"x __	PR14 x __	

\* SECOND DIMENSION REQUIRED

# HVAC ACCESSORIES

## SQUARE TO ROUND TRANSITION BOX

BASE SIZE	TRANSITION TO ROUND SIZE	MODEL #	CTN QTY
6" x 6"	SPECIFY DUCT (ROUND) SIZE WITH ORDER 3" - 18"	SDB66	N/A
8" x 8"		SDB88	
10" x 8"		SDB108	
10" x 10"		SDB1010	
12" x 8"		SDB128	
12" x 10"		SDB1210	
12" x 12"		SDB1212	
14" x 8"		SDB148	
14" x 10"		SDB1410	
14" x 12"		SDB1412	
15" x 15"		SDB1515	
16" x 16"		SDB1616	
18" x 18"		SDB1818	



**SDB**

\* OTHER SIZES AVAILABLE, CALL FOR PRICING

## STORM COLLAR

SIZE	MODEL #	CTN QTY	MODEL #	O/D	CTN QTY
STORM COLLAR			STORM COLLAR FOR B-VENT		
3"	SC3	N/A	SCB3	3-5/8"	N/A
4"	SC4		SCB4	4-5/8"	
5"	SC5		SCB5	5-5/8"	
6"	SC6		SCB6	6-5/8"	
7"	SC7		SCB7	7-5/8"	
8"	SC8		SCB8	8-5/8"	
9"	SC9		SCB9	9-5/8"	
10"	SC10		SCB10	11"	
12"	SC12		SCB12	13"	
14"	SC14		SCB14	15"	
16"	SC16		SCB16	17"	
18"	SC18		SCB18	19"	



**SC**

\* O/D = OUTSIDE DIAMETER OF PIPE

# HVAC ACCESSORIES

## VENT COLLAR



**WVC**

SIZE	MODEL #	CTN QTY	SIZE	MODEL #	CTN QTY
GALVANIZED			ALUMINUM		
3"	WVC3	N/A	3"	WVC3A	N/A
4"	WVC4		4"	WVC4A	
5"	WVC5		5"	WVC5A	
6"	WVC6		6"	WVC6A	
7"	WVC7		7"	WVC7A	
8"	WVC8		8"	WVC8A	
9"	WVC9		9"	WVC9A	
10"	WVC10		10"	WVC10A	
12"	WVC12		12"	WVC12A	



**NP**

## NAIL PLATES

SIZE	MODEL #	BDL QTY	CTN QTY
2" x 18"	NP218	50	N/A
2" x 24"	NP224	25	



**VM**

## VENT SCREEN

SIZE	MATERIAL	MODEL #	CTN QTY
6" x 100"	ALUMINUM PERMA KOTE	VM6	N/A

# HVAC ACCESSORIES

## FURNACE FILTER RACK

SIZE	MODEL #	CTN QTY
14" x 20"	FR1420	N/A
14" x 25"	FR1425	
16" x 20"	FR1620	
16" x 25"	FR1625	
18" x 20"	FR1820	
18" x 25"	FR1825	
20" x 20"	FR2020	
20" x 25"	FR2025	



**FR**

\* FITS MOST 1" - 4" FILTERS

# JOIST POCKET LINERS

## JOIST POCKET LINER (JPL)



SIZE	MODEL #	PACKING	CTN QTY
For 1 1/2" and 1 3/4" x 9 1/2" joists	JPL2-9	1 Pallet Minimum	30 units per box, 32 boxes per pallet, 1 pallet JPL2-9 = approx 24 average size home installations
		8 Box Minimum	
		1 Box Minimum	
For 1 1/2", 1 3/4", 2", 2 5/16" and 2 1/2" x 9 1/2" joists	JPL25-9	1 Pallet Minimum	30 units per box, 18 boxes per pallet, 1 pallet JPL25-9 = approx 14 average size home installations
		8 Box Minimum	
		1 Box Minimum	
For 1 1/2", 1 3/4", 2", 2 5/16" and 2 1/2" x 11 7/8" joists	JPL25-11	1 Pallet Minimum	30 units per box, 18 boxes per pallet, 1 pallet JPL25-11 = approx 14 average size home installations
		8 Box Minimum	
		1 Box Minimum	
For skewed, double and triple joists; Beams; Girders x 9 1/2" & 7 1/2" joists	JPL55-9	1 Pallet Minimum	10 units per box, 18 boxes per pallet
		8 Box Minimum	
		1 Box Minimum	



The Joist Pocket Liner® is the newest approach in floor construction.

The JPL creates a pocket in concrete foundation walls to support the end of an engineered wood I-joist or a conventional wood floor joist. The result is a new standard in floor strength, performance, and silence.

The JPL is a high-density, polyethylene component used to form pockets



(block outs) in foundation walls, so that the ends of each floor joist can be supported directly by the foundation wall.

This system provides labor and material savings over conventional methods of joist support.

JPLs are made in different depths and widths to accommodate various sizes of I-joists and dimensional wood joists.

# ROOFING METALS

## ROOF EDGE

### DRIP EDGE 1½" X 1½"

ITEM#	COLOR	LENGTH FT	GAUGE	WEIGHT EA	PER CTN
DE15	GALVANIZED	10	28	1.64	20
DE15BK	BLACK	10	28	1.64	20
DE15BR	BROWN	10	28	1.64	20
DE15GR	GRAY	10	28	1.64	20
DE15WH	WHITE	10	28	1.64	20

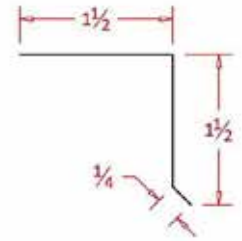

### DRIP EDGE 2" X 2"

ITEM#	COLOR	LENGTH FT	GAUGE	WEIGHT EA	PER CTN
DE22	GALVANIZED	10	28	2.18	10
DE22BK	BLACK	10	28	2.18	10
DE22BR	BROWN	10	28	2.18	10
DE22GR	GRAY	10	28	2.18	10
DE22WH	WHITE	10	28	2.18	10

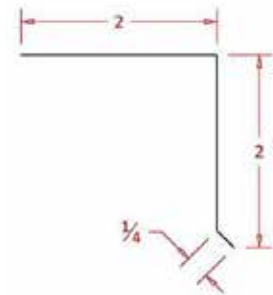

### DRIP EDGE 3" X 3"

ITEM#	COLOR	LENGTH FT	GAUGE	WEIGHT EA	PER CTN
DE33	GALVANIZED	10	28	3.26	10
DE33BK	BLACK	10	28	3.26	10
DE33BR	BROWN	10	28	3.26	10
DE33GR	GRAY	10	28	3.26	10
DE33WH	WHITE	10	28	3.26	10

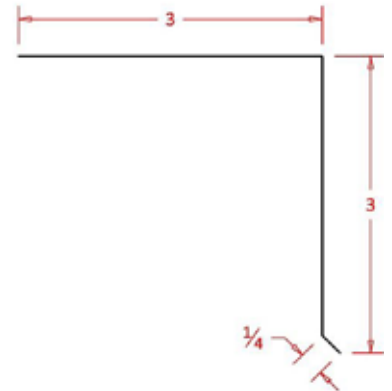



# ROOFING METALS

## ROOF EDGE

### STYLE-D DRIP EDGE

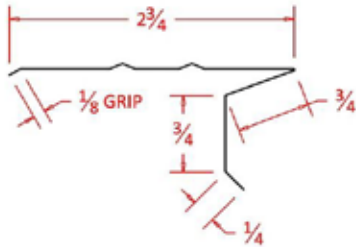

ITEM#	COLOR	LENGTH FT	GAUGE	WEIGHT EA	PER CTN
SD	GALVANIZED	10	28	2.52	25
SDBK	BLACK	10	28	2.52	25
SDBR	BROWN	10	28	2.52	25
SDGR	GRAY	10	28	2.52	25
SDWH	WHITE	10	28	2.52	25

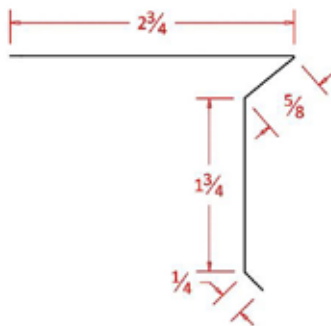

### STYLE-D 1 3/4" WIDE FACE DRIP EDGE

ITEM#	COLOR	LENGTH FT	GAUGE	WEIGHT EA	PER CTN
SDWF	GALVANIZED	10	28	2.92	10
SDWFBK	BLACK	10	28	2.92	10
SDWFBR	BROWN	10	28	2.92	10
SDWFGR	GRAY	10	28	2.92	10
SDWFWH	WHITE	10	28	2.92	10

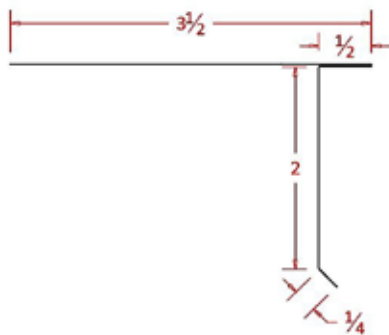

### STYLE-D 2" WIDE FACE DRIP EDGE

ITEM#	COLOR	LENGTH FT	GAUGE	WEIGHT EA	PER CTN
SDWF2	GALVANIZED	10	28	3.26	10
SDWF2BK	BLACK	10	28	3.26	10
SDWF2BR	BROWN	10	28	3.26	10
SDWF2GR	GRAY	10	28	3.26	10
SDWF2WH	WHITE	10	28	3.26	10

# ROOFING METALS

## ROOF EDGE

### STYLE-D WITH 5" ROOF RETURN

ITEM#	COLOR	LENGTH FT	GAUGE	WEIGHT EA	PER CTN
SDWF1	GALVANIZED	10	28	3.73	10
SDWF1BK	BLACK	10	28	3.73	10
SDWF1BR	BROWN	10	28	3.73	10
SDWF1GR	GRAY	10	28	3.73	10
SDWF1WH	WHITE	10	28	3.73	10

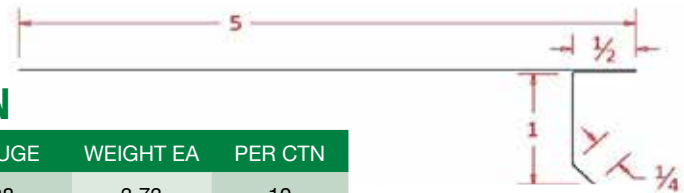

### STYLE-D 1½" WIDE FACE WITH 5" ROOF RETURN

ITEM#	COLOR	LENGTH FT	GAUGE	WEIGHT EA	PER CTN
SDWF15	GALVANIZED	10	28	3.73	10
SDWF15BK	BLACK	10	28	3.73	10
SDWF15BR	BROWN	10	28	3.73	10
SDWF15GR	GRAY	10	28	3.73	10
SDWF15WH	WHITE	10	28	3.73	10

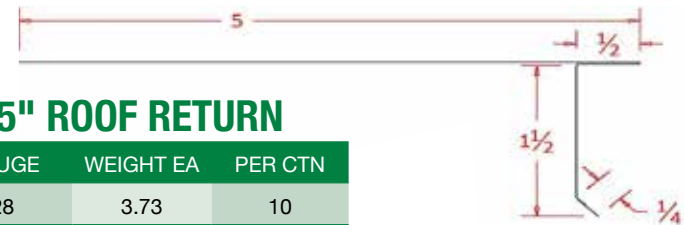

### DRIP EDGE 1½ " WIDE FACE WITH OPEN HEM

ITEM#	COLOR	LENGTH FT	GAUGE	WEIGHT EA	PER CTN
DEL90	GALVANIZED	10	30	2.2	10
DEL90BK	BLACK	10	30	2.2	10
DEL90BR	BROWN	10	30	2.2	10
DEL90WH	WHITE	10	30	2.2	10

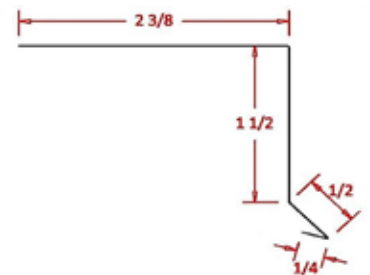

# ROOFING METALS

## ROOF EDGE

### DRIP EDGE 1 1/4" WITH OPEN HEM

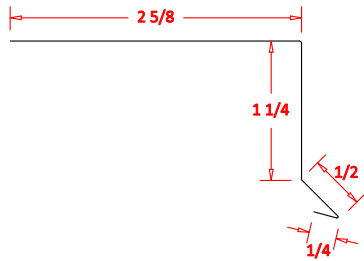

ITEM#	COLOR	LENGTH FT	GAUGE	WEIGHT EA	PER CTN
DE90	GALVANIZED	10	30	2.2	10
DE90BK	BLACK	10	30	2.2	10
DE90BR	BROWN	10	30	2.2	10
DE90BZ	BRONZE	10	30	2.2	10
DE90CL	CLAY	10	30	2.2	10
DE90GR	GRAY	10	30	2.2	10
DE90GRN	FOREST GREEN	10	30	2.2	10
DE90MBR	MUSKET BROWN	10	30	2.2	10
DE90SND	SAND	10	30	2.2	10
DE90TN	TAN	10	30	2.2	10
DE90TBZ	TERRA BRONZE	10	30	2.2	10
DE90WH	WHITE	10	30	2.2	10

### Z-BAR GALVANIZED

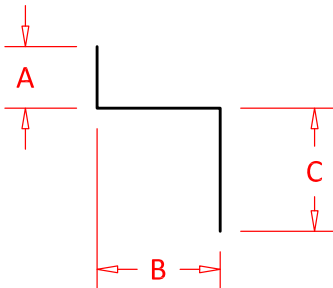

ITEM#	MATERIAL	LENGTH FT	GAUGE	WEIGHT EA	A	PER CTN
ZB516	GALVANIZED	10	28	.94	$\frac{5}{16}$	20
ZB38	GALVANIZED	10	28	.98	$\frac{3}{8}$	20
ZB12	GALVANIZED	10	28	1.06	$\frac{1}{2}$	20
ZB58	GALVANIZED	10	28	1.75	$\frac{5}{8}$	20
ZB34	GALVANIZED	10	28	1.88	$\frac{3}{4}$	20
ZB1	GALVANIZED	10	28	2.14	1	20

## ROOF EDGE

### 3X3 MINI GRAVEL STOP 1/8" RISE 3" FACE

ITEM#	COLOR	LENGTH FT	GAUGE	WEIGHT EA	PER CTN
MDGS	GALVANIZED	10	28	3.26	10

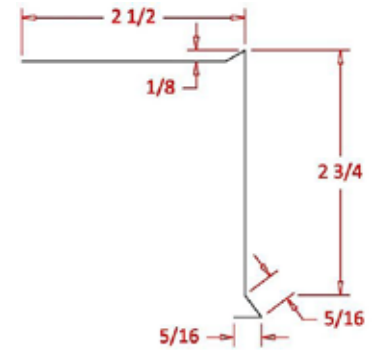

### 3X3 STANDARD GRAVEL STOP 1/4" RISE 3" FACE

ITEM#	COLOR	LENGTH FT	GAUGE	WEIGHT EA	PER CTN
LRGS	GALVANIZED	10	28	3.26	10

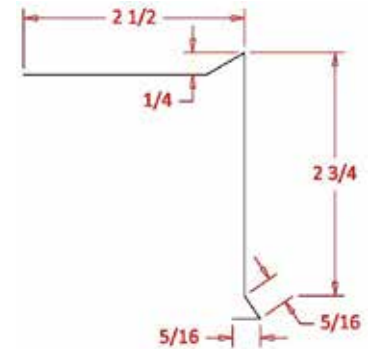

### 3X3 HIGH RISE GRAVEL STOP 1/2" RISE 3" FACE

ITEM#	COLOR	LENGTH FT	GAUGE	WEIGHT EA	PER CTN
HRGS	GALVANIZED	10	28	3.26	10

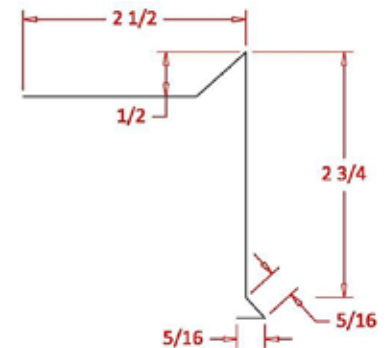

# ROOFING METALS

## ROOF EDGE

### C-METAL 3" X 1" X 1"

ITEM#	COLOR	LENGTH FT	GAUGE	WEIGHT EA	PER CTN
CM311	GALVANIZED	10	28	2.72	10
CM311BK	BLACK	10	28	2.72	10
CM311BR	BROWN	10	28	2.72	10
CM311GR	GRAY	10	28	2.72	10
CM311WH	WHITE	10	28	2.72	10

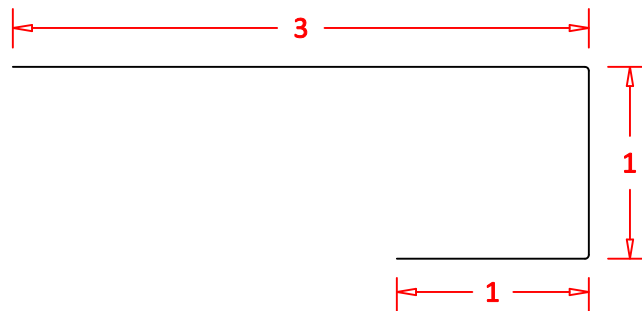

### ROOF STARTER 4¼"

ITEM#	COLOR	LENGTH FT	GAUGE	WEIGHT EA	PER CTN
RS4.25	GALVANIZED	10	28	2.31	10
RS4.25BK	BLACK	10	28	2.31	10
RS4.25BR	BROWN	10	28	2.31	10
RS4.25GR	GRAY	10	28	2.31	10
RS4.25WH	WHITE	10	28	2.31	10

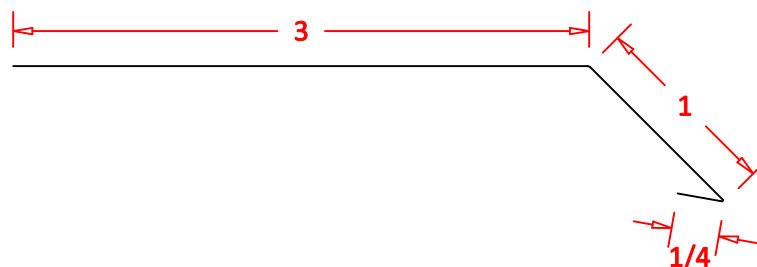

## ROOF FLASHING

### L-FLASHING 90°

ITEM#	COLOR	LENGTH FT	GAUGE	WEIGHT EA	A	B	PER CTN
LF13	GALVANIZED	10	28	2.17	1	3	10
LF23	GALVANIZED	10	28	2.72	2	3	10
LF33	GALVANIZED	10	28	3.26	3	3	10
LF44	GALVANIZED	10	28	4.35	4	4	10
LF44BK	BLACK	10	28	4.35	4	4	10
LF44BR	BROWN	10	28	4.35	4	4	10
LF44GR	GRAY	10	28	4.35	4	4	10
LF44WH	WHITE	10	28	4.35	4	4	10
LF66	GALVANIZED	10	28	6.52	6	6	10

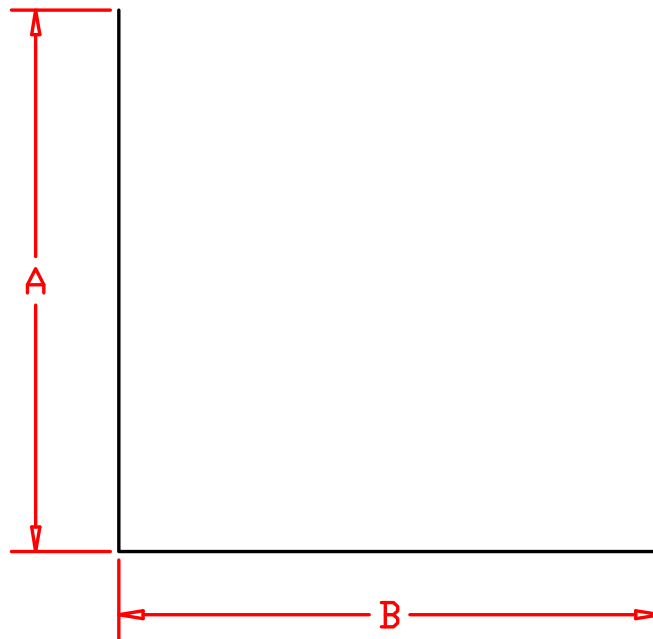

# ROOFING METALS

## ROOF FLASHING

### ROOF TO WALL 3" X 5" 110°

ITEM#	COLOR	LENGTH FT	GAUGE	WEIGHT EA	PER CTN
RW35	GALVANIZED	10	28	4.35	10
RW35BK	BLACK	10	28	4.35	10
RW35BR	BROWN	10	28	4.35	10
RW35GR	GRAY	10	28	4.35	10
RW35WH	WHITE	10	28	4.35	10



## ROOF FLASHING

### ROOF TO WALL 4" X 4" 110°

ITEM#	COLOR	LENGTH FT	GAUGE	WEIGHT EA	PER CTN
RW44	GALVANIZED	10	28	4.35	10
RW44BK	BLACK	10	28	4.35	10
RW44BR	BROWN	10	28	4.35	10
RW44GR	GRAY	10	28	4.35	10
RW44WH	WHITE	10	28	4.35	10

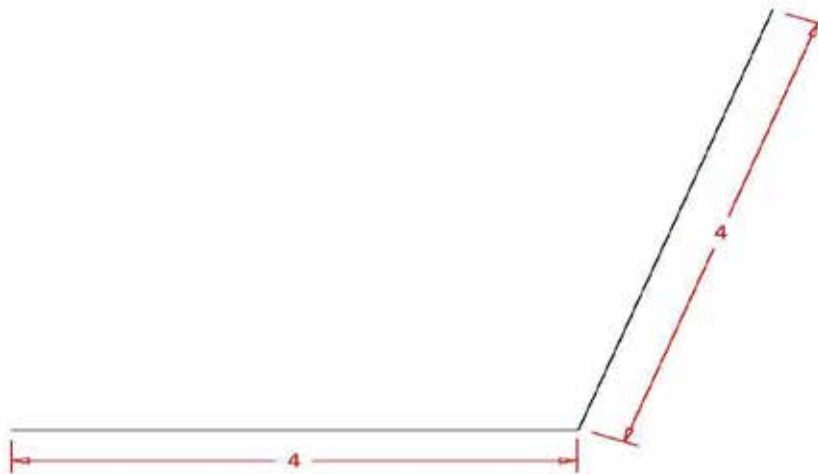



# ROOFING METALS

## ROOF FLASHING

### COUNTER FLASHING 5"

ITEM#	COLOR	LENGTH FT	GAUGE	WEIGHT EA	PER CTN
CF5	GALVANIZED	10	28	2.72	10
CF5BK	BLACK	10	28	2.72	10
CF5BR	BROWN	10	28	2.72	10
CF5GR	GRAY	10	28	2.72	10
CF5WH	WHITE	10	28	2.72	10

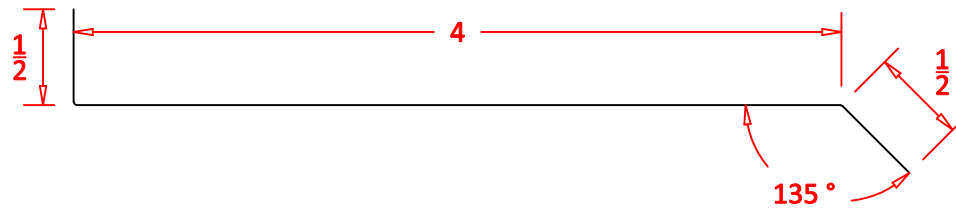

### COUNTER FLASHING 7" X 36"

ITEM#	COLOR	LENGTH FT	GAUGE	WEIGHT EA	PER CTN
CF736	GALVANIZED	10	28	1.14	10

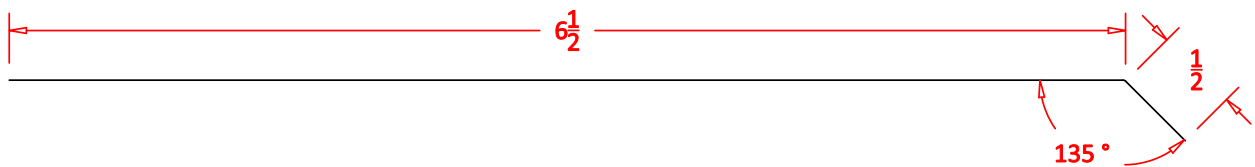

## ROOF FLASHING

### TILE PAN 5" X 6" X 3/4"

ITEM#	COLOR	LENGTH FT	GAUGE	WEIGHT EA	PER CTN
TP56	GALVANIZED	10	28	6.56	10
TP56BK	BLACK	10	28	6.56	10
TP56BR	BROWN	10	28	6.56	10
TP56GR	GRAY	10	28	6.56	10
TP56WH	WHITE	10	28	6.56	10

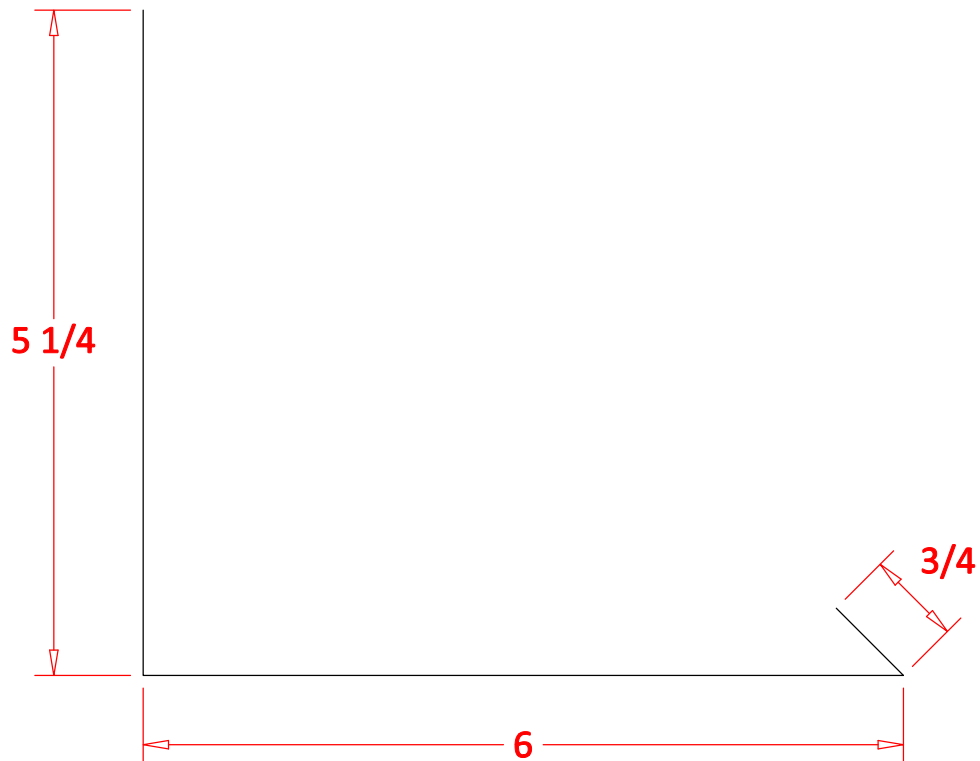

# ROOFING METALS

## SHINGLES

### STEP SHINGLES

ITEM#	COLOR	GAUGE	WEIGHT EA	A	B	C	PER BDL
SS34750	GALVANIZED	30	9.5	3	4	7	50
SS44850	GALVANIZED	30	12	4	4	8	50
SS448BK50	BLACK	28	14.5	4	4	8	50
SS448BR50	BROWN	28	14.5	4	4	8	50
SS441250	GALVANIZED	30	18	4	4	12	50
SS4412BK50	BLACK	28	22	4	4	12	50
SS4412BR50	BROWN	28	22	4	4	12	50
SS441450	GALVANIZED	30	20.6	4	4	14	50
SS4414BK50	BLACK	28	25	4	4	14	50
SS4414BR50	BROWN	28	25	4	4	14	50
SS46750	GALVANIZED	30	13	4	6	7	50

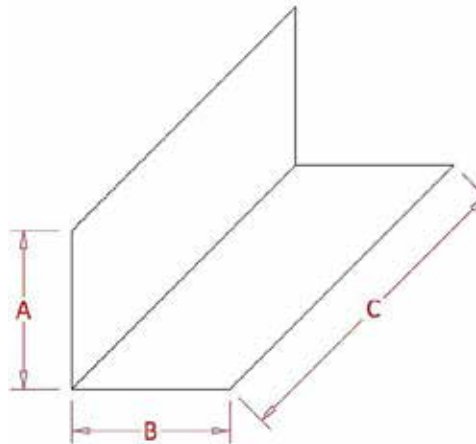

### FLAT SHINGLES

ITEM#	COLOR	GAUGE	WEIGHT EA	PER BDL
FS81250	GALVANIZED	30	17.7	50
FS812BKBR50	BLACK	28	21.53	50
FS812BKBR50	BROWN	28	21.53	50

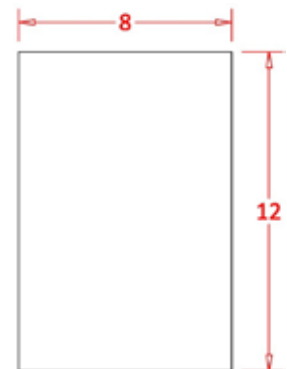

# ROOFING METALS

## VALLEY METAL

### ROLL VALLEY

ITEM#	COLOR	LENGTH FT	GAUGE	WEIGHT EA	A
RV105030	GALVANIZED	50	30	22.1	10
RV145030	GALVANIZED	50	30	31	14
RV1450BKBR	BLACK	50	28	38	14
RV1450BKBR	BROWN	50	28	38	14
RV205030	GALVANIZED	50	30	44.2	20
RV2050BKBR	BLACK	50	28	54.4	20
RV2050BKBR	BROWN	50	28	54.4	20

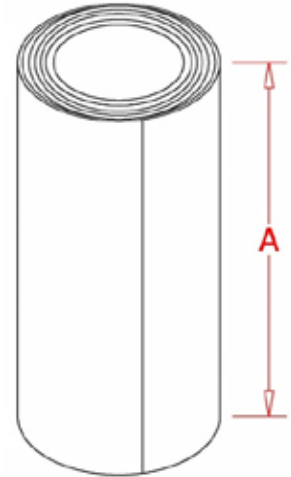

## W-VALLEY

### 24" W-VALLEY

ITEM#	COLOR	LENGTH FT	GAUGE	WEIGHT EA	PER CTN
WV24	GALVANIZED	10	28	13.02	10
WV24BK	BLACK	10	28	13.87	10
WV24BR	BROWN	10	28	13.87	10
WV24GR	GRAY	10	28	13.87	10
WV24WH	WHITE	10	28	13.87	10

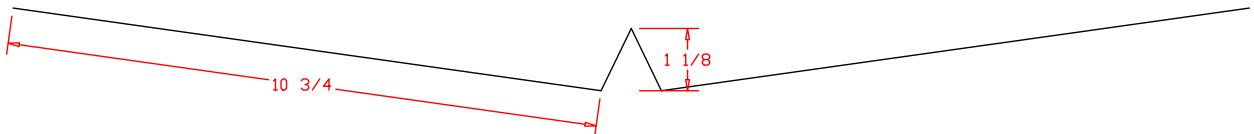

# ROOFING METALS

## 24" W-VALLEY RIBBED

ITEM#	COLOR	LENGTH FT	GAUGE	WEIGHT EA	PER CTN
WV245V	GALVANIZED	10	28	13.02	10
WV24BK5V	BLACK	10	28	13.87	10
WV24BR5V	BROWN	10	28	13.87	10
WV24GR5V	GRAY	10	28	13.87	10
WV24WH5V	WHITE	10	28	13.87	10

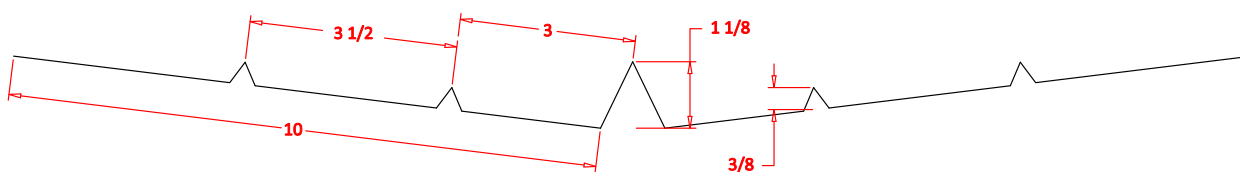





649 N. Ralstin St.  
Meridian, Idaho 83642  
P: 208-884-8931  
TF: 800-234-1903  
F: 208-884-8943

[www.famcomfg.com](http://www.famcomfg.com)  
[sales@famcomfg.com](mailto:sales@famcomfg.com)

© FAMCO, Meridian, ID

MADE IN USA