

ACCESSORIES BOX

BOITE ACCESSOIRES

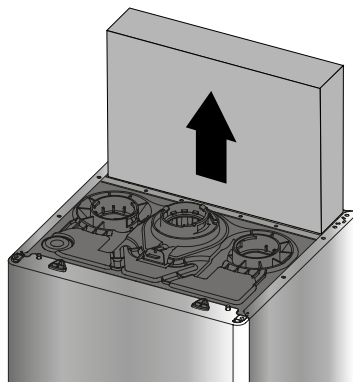

**For Qualified Technician
Installation Instructions**

***Pour technicien qualifié
instructions d'installation***

Read the code

Lire le code

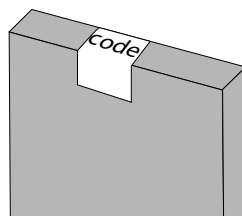

Accessories box code 560020065900 (models 150C & 120)	page 3
Accessories box code 560020066000 (model 110C/120C)	page 7
Accessories box code 560020066100 (model 085)	page 9

<i>Boite Accessoires code 560020065900 (models 150C & 120)</i>	<i>page 3</i>
<i>Boite Accessoires code 560020066000 (model 110C/120C)</i>	<i>page 7</i>
<i>Boite Accessoires code 560020066100 (model 085)</i>	<i>page 9</i>

Code 560020065900 (models 150C & 120)

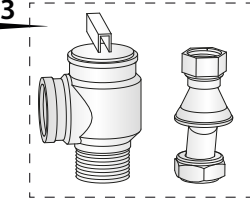
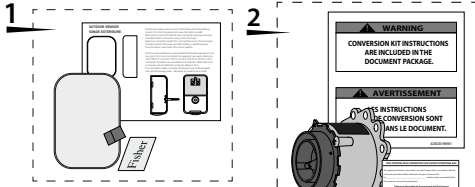

Nr.	Quantity	Description
1	1	Outdoor sensor Kit
2	1	LP Gas Conversion Kit
3	1+1	CH Pressure Relief Valve + Connection Tube
4	1	2" CPVC Pipe, 5.5" Long
5	1	Piping Bracket
6	1	Torx screw adapter
7	2+2	2" Vent Screen + 3" Vent Screen
8	1	Tridicator
9	2	Cap 1/2"
10	7	Gasket (2x1/2" + 3x3/4" + 1 x 1" + 1 gas flat)
11	4	Clamp (2x3/4" + 2x1")
12	1	Gas Adapter 3/4"
13	1	CH supply pipe 1"
14	1	CH return pipe 1"
15	1	DHW outlet pipe (150C)/Tank return pipe (120) 3/4"
16	1	DHW inlet flow restrictor (150C) 1/2" x 3/4"
17	1	DHW inlet pipe 3/4"

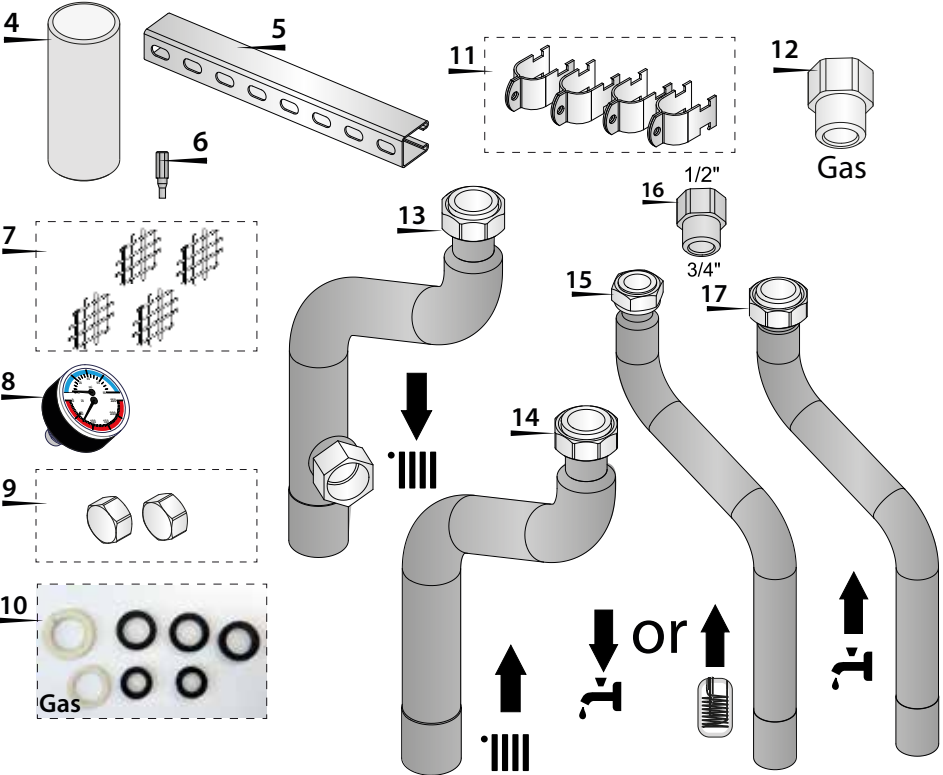

150C Assembly

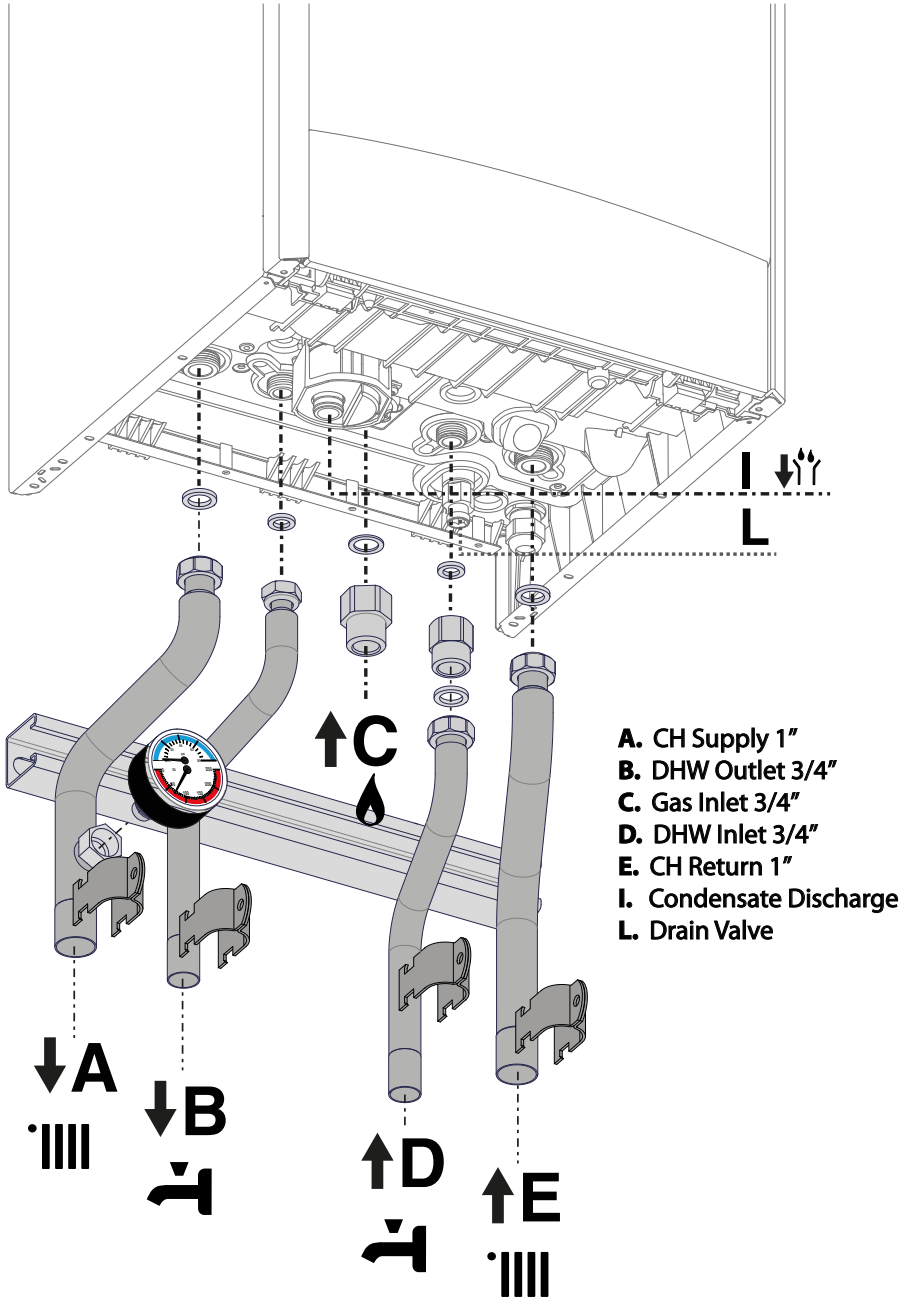

120 Assembly (without IWH)

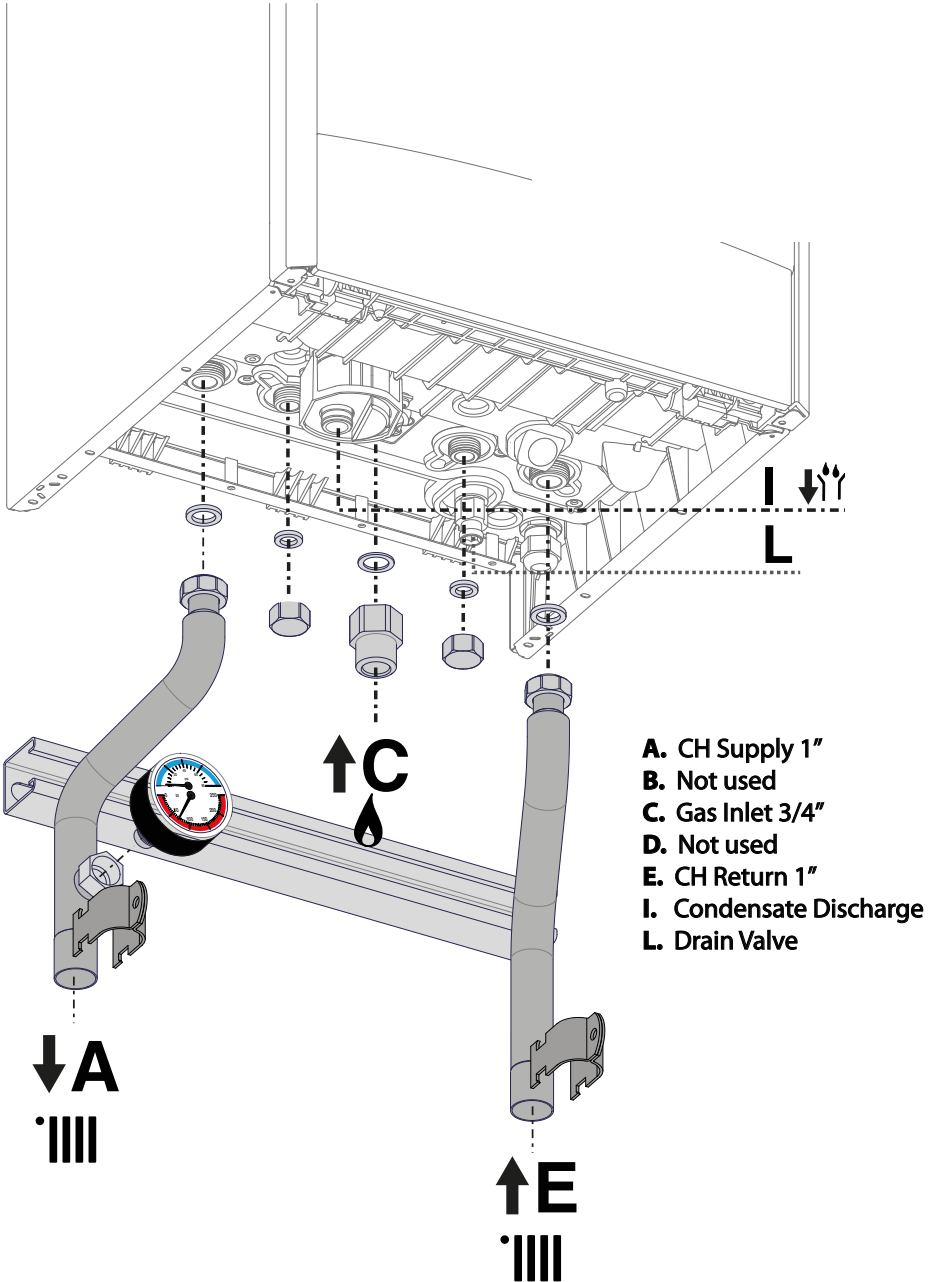

120 Assembly (with IWH)

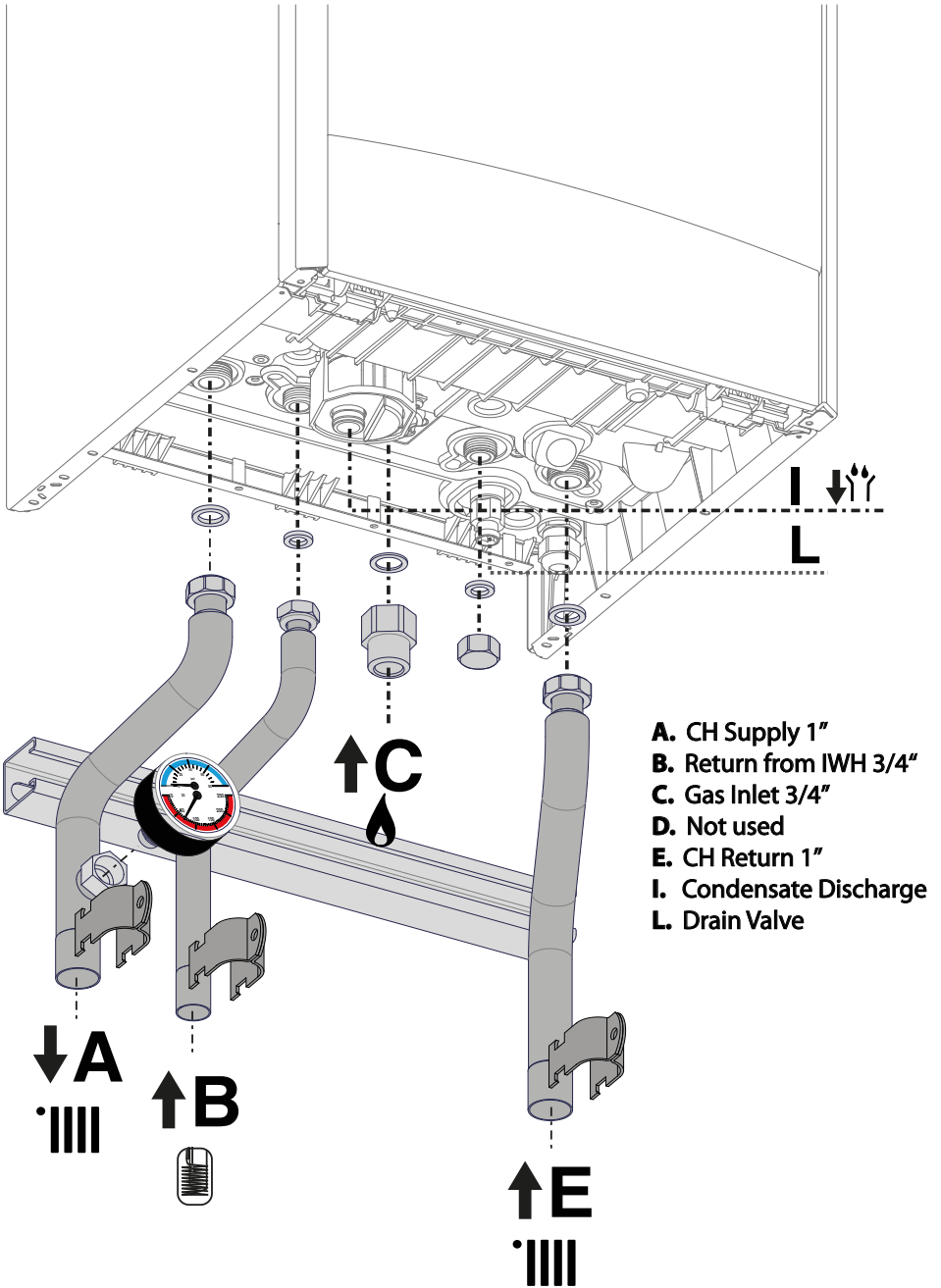

code 560020066000 (model 110C/120C)

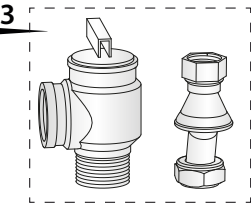
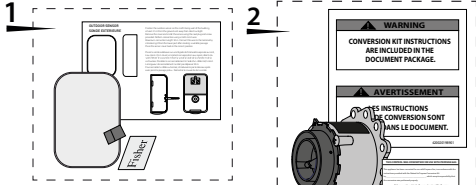

Nr.	Quantity	Description
1	1	Outdoor sensor Kit
2	1	LP Gas Conversion Kit
3	1+1	CH Pressure Relief Valve + Connection Tube
4	1	2" CPVC Pipe, 5.5" Long
5	1	Piping Bracket
6	1	Torx screw adapter
7	2 + 2	2" Vent Screen + 3" Vent Screen
8	1	Tridicator
9	6	Gasket (2x1/2" + 2x3/4" + 1 x 1" + 1 gas flat)
10	4	Clamp (2x3/4" + 2x1")
11	1	Gas Adapter 3/4"
12	1	CH supply pipe 1"
13	1	CH return pipe 1"
14	2	DHW outlet & inlet pipes 3/4"

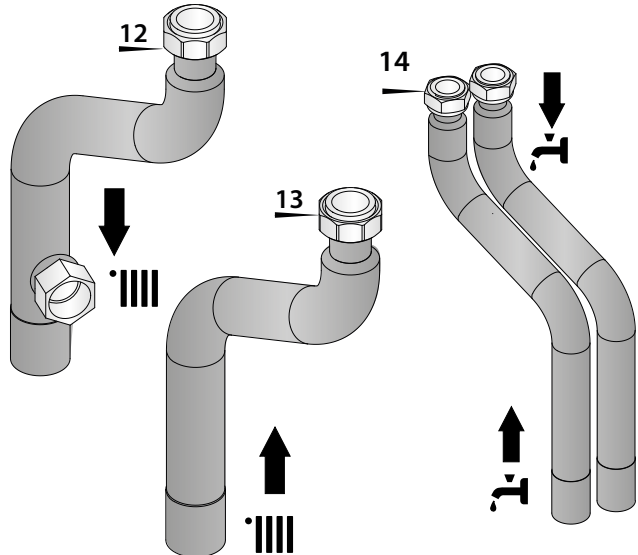
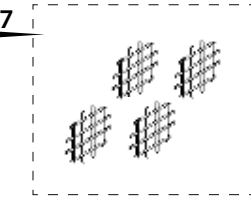
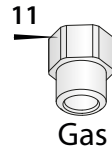
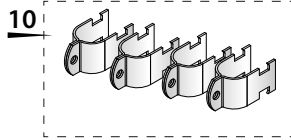
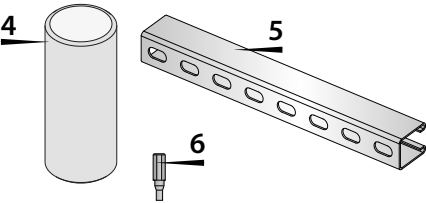

110C/120C Assembly

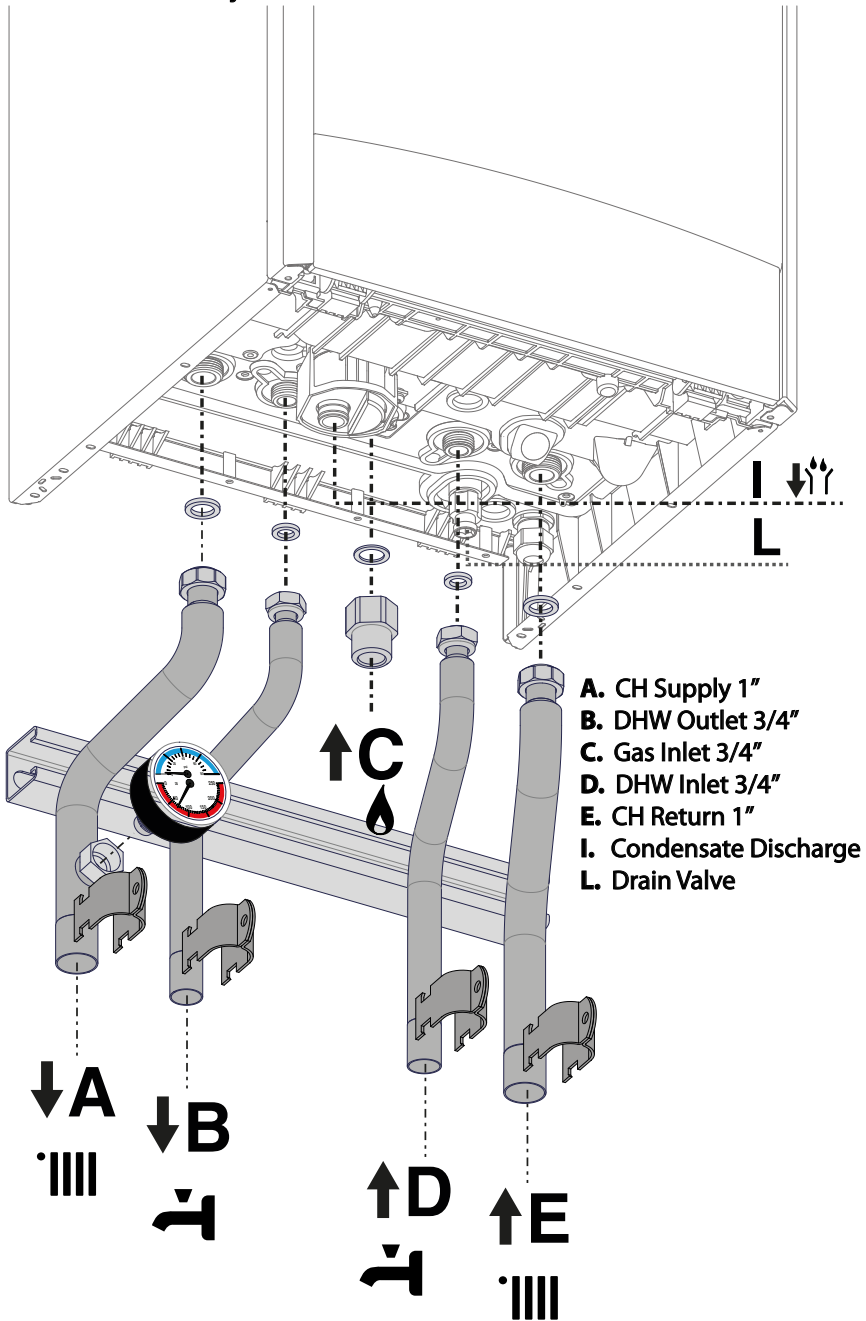

code 560020066100 (model 085)

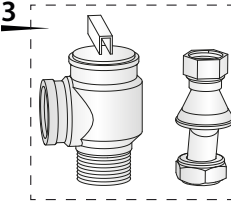
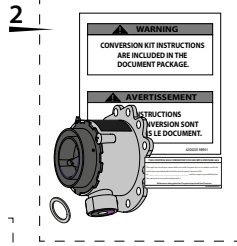
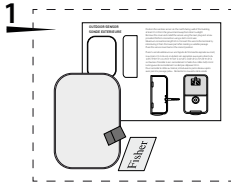

Nr.	Quantity	Description
1	1	Outdoor sensor Kit
2	1	LP Gas Conversion Kit
3	1+1	CH Pressure Relief Valve + Connection Tube
4	1	2" CPVC Pipe, 5.5" Long
5	1	Piping Bracket
6	1	Torx screw adapter
7	2+2	2" Vent Screen + 3" Vent Screen
8	1	Tridicator
9	2	Cap 1/2"
10	6	Gasket (2x1/2" + 2x3/4" + 1 x 1" + 1 gas flat)
11	4	Clamp (2x3/4" + 2x1")
12	1	Gas Adapter 3/4"
13	1	CH supply pipe 1"
14	1	CH return pipe 1"
15	1	Tank return pipe 3/4"

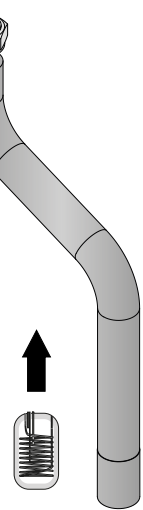
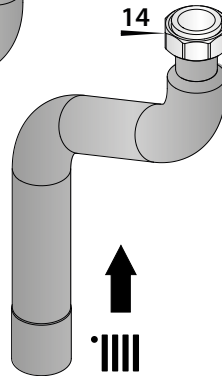
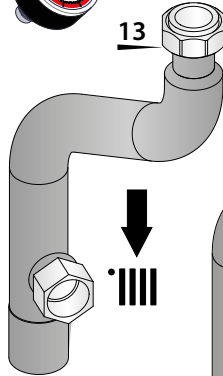
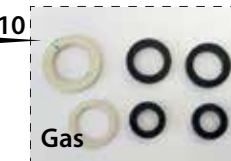
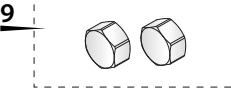
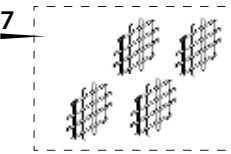
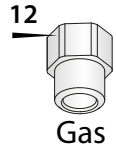
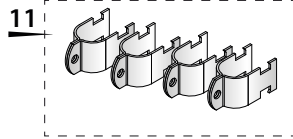
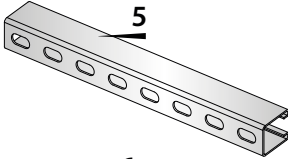
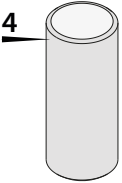

085 Assembly (without IWH)

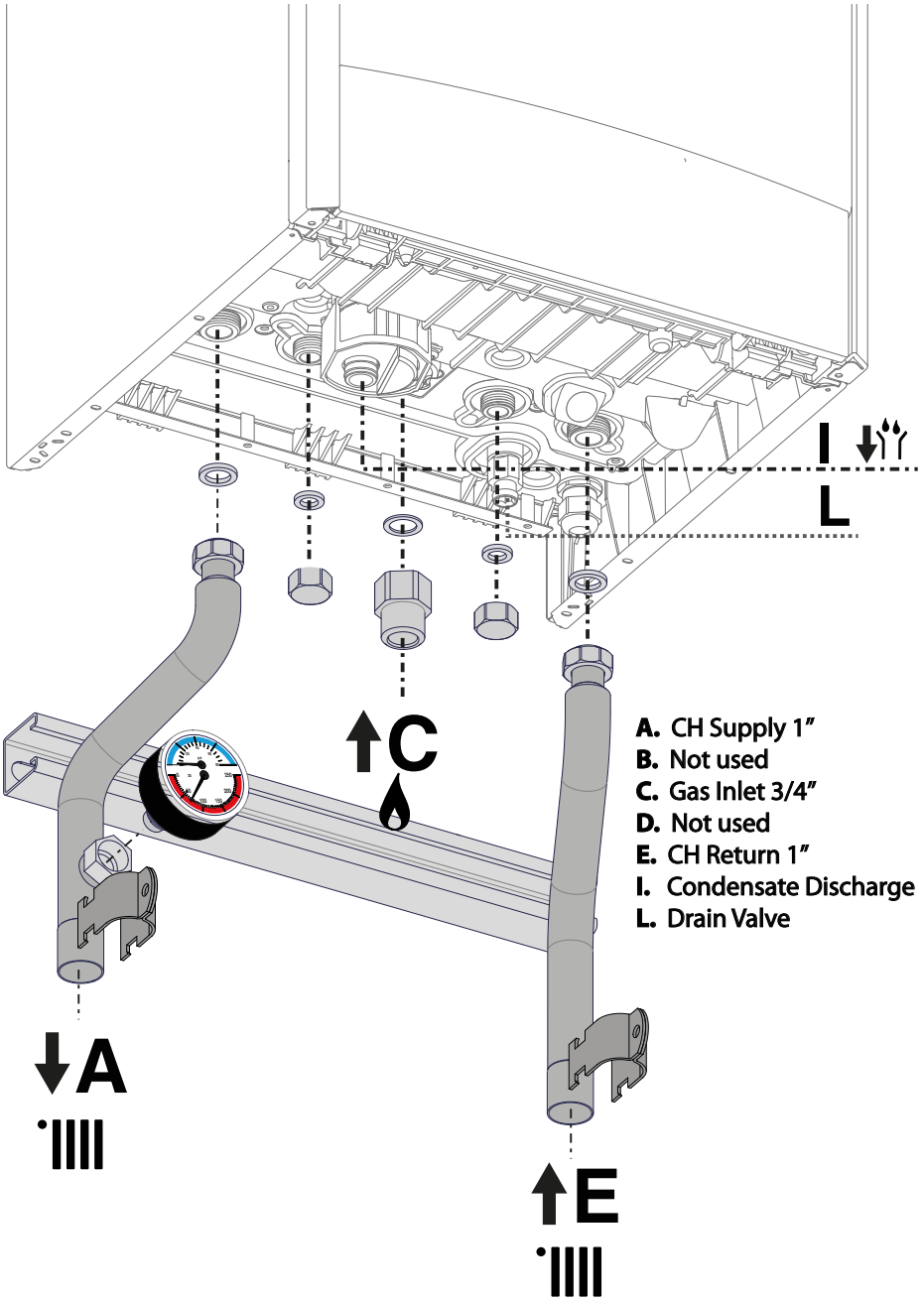

085 Assembly (with IWH)

